



OPERATION MANUAL

RESISTOMAT® Model 2311

© 2024 burster
präzisionsmesstechnik gmbh & co. kg
All rights reserved

Manufacturer:
burster
präzisionsmesstechnik gmbh & co. kg
Talstrasse 1 - 5 Postfach 1432
76593 Gernsbach 76587 Gernsbach
Germany Germany

Valid from: March 8, 2024

Tel.: +49 7224 645-0

Fax: +49 7224 64588
Email: info@burster.de
www.burster.com

4525-BA2311DE-5699-031527

Warranty disclaimer

All information in the present documentation was prepared and compiled with great care and reproduced in accordance with effective control measures. No warranty is provided for freedom from errors. We reserve the right to make technical changes. The present information as well as the corresponding technical data can change without notice. Reproduction of any part of this documentation or its processing or revision using electronic systems is prohibited without the manufacturer's prior written approval.

Components, devices and measurement sensors made by burster präzisionsmesstechnik (hereinafter referred to as the "product") are the result of targeted development and meticulous research. From the date of delivery, burster provides a warranty for the proper condition and functioning of these products covering material and production defects for the period specified in the warranty document accompanying the product. However, burster waives any guarantee or warranty obligations or any additional liability for consequential damages caused by improper use of the product, in particular the implied guarantee of success in the market as well as the suitability of the product for a particular purpose. Furthermore, burster assumes no liability for direct, indirect or incidental damages or for consequential or other damages arising from the provision and use of the present documentation.

Trademark information

All brand names or trademarks mentioned in this document refer solely to the products concerned and are the property of their respective owners. By mentioning these trademarks, burster präzisionsmesstechnik gmbh & co. kg is not laying claim to trademarks other than its own.



THE MEASUREMENT SOLUTION.

EU-Konformitätserklärung (nach EN ISO/IEC 17050-1:2010)

EU-Declaration of conformity (in accordance with EN ISO/IEC 17050-1:2010)

Name des Ausstellers: burster präzisionsmesstechnik gmbh & co kg
Issuer's name:

Anschrift des Ausstellers: Talstr. 1-5
Issuer's address: 78593 Gernsbach, Germany

Gegenstand der Erklärung: RESISTOMAT® zur Highspeed-Widerstandsmessung
 in der Automation
Object of the declaration: RESISTOMAT® for high-speed resistance measurement
 in automation

Modellnummer(n) (Typ): RESISTOMAT® 2311
Model number / type:

Diese Erklärung beinhaltet obengenannte Produkte mit allen Optionen
This declaration covers all options of the above product(s)

Das oben beschriebene Produkt ist konform mit den Anforderungen der folgenden Dokumente:
The object of the declaration described above is in conformity with the requirements of the following documents:

Dokument-Nr. <i>Documents No.</i>	Titel <i>Title</i>	Ausgabe <i>Edition</i>
2011/65/EU + delegD (EU) 2015/863	Richtlinie zur Beschränkung der Verwendung bestimmter gefährlicher Stoffe in Elektro- und Elektronikgeräten <i>Directive on the restriction of the use of certain hazardous substances in electrical and electronic equipment</i>	2011 + 2015
2014/35/EU	Richtlinie zur Harmonisierung der Rechtsvorschriften der Mitgliedsstaaten über die Bereitstellung elektrischer Betriebsmittel zur Verwendung innerhalb bestimmter Spannungsgrenzen auf dem Markt <i>Directive on the harmonization of the laws of the Member States relating to the making available on the market of electrical equipment designed for use within certain voltage limits</i>	2014
2014/30/EU	Richtlinie zur Harmonisierung der Rechtsvorschriften der Mitgliedsstaaten über die Elektromagnetische Verträglichkeit <i>Directive on the harmonization of the laws of the Member States relating to electromagnetic compatibility</i>	2014
EN 61010-1	Sicherheitsbestimmungen für elektrische Mess-, Steuer-, Regel- und Laborgeräte – Teil 1: Allgemeine Anforderungen <i>Safety requirements for electrical equipment for measurement, control and laboratory use – Part 1: General requirements</i>	2020 + A1:2022 + A2:2023
EN 61326-1	Elektrische Mess-, Steuer-, Regel- und Laborgeräte – EMV-Anforderungen – Teil 1: Allgemeine Anforderungen <i>Electrical equipment for measurement, control and laboratory use – EMC requirements – Part 1: General requirements</i>	2022
EN 55011	Industrielle, wissenschaftliche und medizinische Geräte – Funkstörungen – Grenzwerte und Messverfahren, Gruppe 1, Grenzwertklasse A <i>Industrial, scientific and medical equipment – Radio-frequency disturbance characteristics – Limits and methods of measurement, group 1, class A</i>	2022

Gernsbach 12.04.2023 ppa. Christian Karius
Ort / place Datum / date Quality Manager

Dieses Dokument ist entsprechend EN ISO/IEC 17050-1:2010 Abs. 6.1g ohne Unterschrift gültig /
 According EN ISO/IEC 17050 this document is valid without a signature.
 burster präzisionsmesstechnik gmbh & co kg

Talstr. 1-5 | D-78593 Gernsbach
 Tel: (+49) 07224 6450
 info@burster.com

Geschäftsführer/Managing Director: Matthias Rieder
 Handelsregister/Trade Register: Gernsbach
 Registergericht/Register Court: Mannheim HRB 330170

Kompl./Gen. Partner: burster präzisionsmesstechnik Verwaltungs GmbH
 Handelsregister/Trade Register: Gernsbach
 Registergericht/Register Court: Mannheim HRB 330130

burster is ISO 9001:2015 certified

www.burster.com

Contents

1	For your safety	8
1.1	Symbols used in the operation manual	8
1.1.1	Signal words.....	8
1.1.2	Pictograms	9
1.2	Symbols and precautionary statements on the device	9
1.2.1	Conventions used in the operating manual	9
2	Introduction	10
2.1	Intended use	10
2.2	Customer service	10
2.2.1	Customer service department.....	10
2.2.2	Contact person.....	10
2.3	Download the test certificate.....	11
2.4	Ambient conditions	11
2.4.1	Storage conditions	11
2.4.2	Operating conditions	11
2.4.3	Restrictions on use	11
2.4.4	Cleaning	12
2.5	Personnel.....	12
2.6	Contents of pack.....	12
2.7	Unpacking.....	13
2.8	Warranty	13
2.9	Conversions and modifications.....	13
2.10	Using the device for the first time	14
2.10.1	Setup and installation, storage.....	14
2.11	Error messages when the unit is powered up	14
3	Device concept	16
3.1	Functional scope.....	16
3.2	Versions	16
3.3	Power supply	17
4	Controls and connections	18
4.1	Front panel.....	18
4.2	Rear panel	19
4.3	Touch operation	20
4.4	Controls and symbols	21
4.5	Grounding, shielding and connection wiring.....	22
4.6	Connections	23
4.6.1	PLC I/O signals	23
4.6.2	Measurement input	25
4.6.3	Connection: Pt100 sensor.....	26
4.6.4	External multiplexer port	26
4.6.5	USB service port	27

4.6.6	Ethernet port	28
4.6.7	USB host port (memory stick data logging)	28
4.6.8	Ethernet-based fieldbus interface (dual RJ-45)	28
4.6.9	Device power plug	28
5	Using the device for the first time	29
5.1	Panel mounting	29
5.1.1	Panel mounting	29
5.1.2	Panel cutout	30
5.2	User language and diagnostics	31
6	Device configuration – “Configuration Main Menu”	32
6.1	Basic Setup	33
6.1.1	Function Key Definition	34
6.1.2	PLC Outputs	35
6.1.3	PLC Inputs	37
6.1.4	Access Permissions	38
6.1.4.1	Changing the master/user password	38
6.1.4.2	Specifying access levels for master/user	38
6.1.4.3	Blocking/unblocking access by the DigiControl PC software	39
6.1.5	Device Information	39
6.1.6	LCD Settings	40
6.1.7	Date and Time	40
6.1.8	Language	41
6.1.9	Interfaces	41
6.1.9.1	USB interface parameters	42
6.1.9.2	Ethernet interface parameters	43
6.1.10	USB Memory	44
6.1.11	Diagnostics	45
6.1.12	Order Sheet	46
6.1.13	EtherCAT settings (option)	47
6.1.14	PROFINET settings (option)	47
6.1.15	EtherNet/IP settings (option)	48
6.2	Evaluation	50
6.2.1	Data Logger	50
6.2.2	Comparator	50
6.2.3	Max / Min	50
6.2.4	Cooling Curve	51
6.3	Calibration	52
6.4	Program Selection	52
6.5	Program Setup menu	53
6.5.1	Measurement Method	53
6.5.1.1	Range selection	54
6.5.1.2	Measuring range	54
6.5.1.3	Minimum and maximum range	55

6.5.1.4	Test object	55
6.5.1.5	Type of measurement.....	56
6.5.1.6	N measurements	57
6.5.1.7	Mean values	57
6.5.1.8	Averaging.....	58
6.5.1.9	Resolution.....	58
6.5.1.10	Limiting	59
6.5.1.11	Conversion	59
6.5.1.12	Measurement sequence.....	59
6.5.1.13	Test current	60
6.5.1.14	If error	61
6.5.1.15	Broken wire test.....	61
6.5.2	Comparator	62
6.5.2.1	Comparator.....	62
6.5.2.2	Limit values.....	63
6.5.2.3	If error	63
6.5.2.4	Limit values <<, <, >, >>	64
6.5.3	Data Logger	64
6.5.3.1	Data Logger	65
6.5.3.2	Filter.....	65
6.5.3.3	Nth value.....	66
6.5.3.4	Delta t	66
6.5.3.5	Delta R.....	67
6.5.3.6	Name	67
6.5.3.7	Free memory	68
6.5.3.8	Delete	68
6.5.4	Max / Min.....	68
6.5.5	Temperature compensation.....	69
6.5.5.1	Compensation	69
6.5.5.2	Source	70
6.5.5.3	Man. Temperature	70
6.5.5.4	Reference temperature.....	70
6.5.5.5	Coefficient.....	71
6.5.5.6	User Coeff.....	71
6.5.6	Pt100.....	72
6.5.7	U Input.....	72
6.5.8	Measured Value Display	73
6.5.9	Cooling Curve	73
6.5.10	USB Memory.....	74
6.5.11	PLC Test.....	74
6.6	Copy Programs.....	76
6.6.1	Copying a measurement program or measurement method.....	76

6.6.2	Deleting a measurement program	76
7	Display in measurement mode	77
7.1	Full view of measured values	78
7.2	Error status display	78
7.2.1	Error status indicator in the error status field	78
8	Customer services for your RESISTOMAT® 2311	79
9	Technical data	79
9.1	Electromagnetic compatibility	79
9.1.1	Interference immunity	79
9.1.2	Interference emission	79
10	Accessories available	80
10.1	Software	80
11	Disposal	81



1 For your safety

The following symbols on the RESISTOMAT® 2311 and in this operation manual warn of hazards.

1.1 Symbols used in the operation manual

1.1.1 Signal words



The following signal words are used in the operation manual according to the specified hazard classification. The signal words introduce warnings that must be followed and acted upon with care to prevent accidents, injuries and damage to property.

	<h2>DANGER</h2>
<p>High degree of risk: indicates a hazardous situation which, if not avoided, will result in death or serious injury.</p>	
	<h2>WARNING</h2>
<p>Moderate degree of risk: indicates a hazardous situation which, if not avoided, may result in death or serious injury.</p>	
	<h2>CAUTION</h2>
<p>Low degree of risk: indicates a hazardous situation which, if not avoided, could result in minor or moderate injury.</p>	
<h2>NOTICE</h2>	
<p>Property damage to the equipment or the surroundings will result if the hazard is not avoided.</p>	

Note: It is important to heed these safety notices in order to ensure you handle the RESISTOMAT® 2311 correctly.

IMPORTANT: Follow the information given in the operation manual.

1.1.2 Pictograms

Symbol	Description
	Electric shock hazard!
	Electrostatic discharge. Do not touch! Avoid electrostatic discharge. Dissipate electrostatic charge.
	Observe the advice for protecting the device.

1.2 Symbols and precautionary statements on the device

Symbol	Description
	Hazard warning Disconnect the power plug before opening – Follow safety instructions – Professional servicing only
Warning ! To prevent electrical shock do not open device.	Warning of electrical shock hazard Do not open the device.
To prevent fire replace only with same type and rating of fuse !	Warning of fire hazard Always replace the fuse with a fuse of the same type and rating.

1.2.1 Conventions used in the operating manual

Designation	Description
[Fx]	Function keys F1 to F3 on the touchscreen display
[Text]	Buttons on the touchscreen display
“Term”	Terms used in the device menus

2 Introduction

IMPORTANT: Read the operation manual carefully before using the equipment, and keep it for future reference.

The operation manual must be read carefully before putting the device into service or carrying out maintenance or other work on the RESISTOMAT® model 2311. All safety instructions and safety regulations relating to accessory equipment / attachments must be observed to ensure safe and proper handling of the device.

Only qualified personnel may perform maintenance work on electrical components (see section 2.5 Personnel). These safety instructions must be included when the RESISTOMAT® model 2311 is sold.

2.1 Intended use

The RESISTOMAT® model 2311 is a device for measuring and evaluating ohmic resistances and ohmic resistances with inductive components in single and recurring production processes with and without compensation of the influence of temperature on the test object. The very fast, single-channel measuring device is preferably used in partially and fully automated processes where the electrical quantity of resistance (e.g. volume, transition, contact or winding resistances) has to be measured and classified or evaluated using comparators / limit values. The result is categorized as “OUT_COMP_=” (good) or “OUT_COMP_<” (too low) or OUT_COMP_> (too high) and made available at various interfaces.

IMPORTANT: The device does not replace a safety device, such as for the emergency shutdown of automatic process machines.

2.2 Customer service

2.2.1 Customer service department

For repair inquiries, please call our customer service department on +49 7224 645-53, or email service@burster.de (in Germany only). In other countries please contact your local representative (see www.burster.com).

Please have the serial number to hand. The serial number is essential to establishing the definite technical status of the instrument and providing help quickly. You will find the serial number on the type plate of the RESISTOMAT® 2311.

2.2.2 Contact person

If you have any questions relating to the RESISTOMAT® 2311, please go directly to burster präzisionsmesstechnik gmbh & co. kg, or if outside Germany, please contact your burster agent (see also www.burster.com).

Head office

burster präzisionsmesstechnik gmbh & co. kg
Talstrasse 1 - 5
76593 Gernsbach
Germany

Phone: +49 7224 645-0
Fax: +49 7224 645-88
Email: info@burster.de

2.3 Download the test certificate

You have the option to download the test certificate for your model 2311 RESISTOMAT® online. Please use the following link <https://www.burster.com/en/service-calibration/download-your-test-and-calibration-certificates-here>. You can then download the test certificate directly by entering the serial number.

2.4 Ambient conditions

2.4.1 Storage conditions

The following requirements must be met when storing the RESISTOMAT® 2311:

- Store at temperatures between -10 °C and +60 °C
- The unit must be packed in clean packaging
- Store in a dry environment
- No condensation

2.4.2 Operating conditions

The following requirements must be met when operating the RESISTOMAT® 2311:

- Indoor operation only
- Maximum height above sea level 2000 m
- Operate at temperatures between +5 °C and +40 °C, ideally +23 °C
- Max. relative humidity: 80 % up to +31 °C, decreasing linearly above that temperature to 50 % at T_{max} , non-condensing
- Protection class: 1 (grounded via power supply plug)
- Transient overvoltage category: CAT II
- Potential with respect to ground: ≤ 12 V DC between analog ground and ground
- Supply voltage for desktop device: 100 to 240 V AC_{eff} (± 10 %), 50 to 60 Hz (± 10 %)
- Supply Voltage for 24 V/DC variants: 20 to 30 V/DC (nominal value 24 V/DC)

Note: Avoid condensation after transportation or storage of the RESISTOMAT® 2311.



2.4.3 Restrictions on use

	 <b style="font-size: 1.2em;">DANGER
<p>The RESISTOMAT® 2311 is not intended as a substitute for safety devices and protective equipment. Use safety devices and protective equipment.</p>	

Note: The RESISTOMAT® 2311 does not pose a hazard if used within its specifications and in accordance with the safety regulations.

Note: The manufacturer does not accept liability for any personal injury or property damage arising from misinterpretation of measurement results.

2.4.4 Cleaning

	 DANGER
	<p>Electric shock hazard! Disconnect the RESISTOMAT® 2311 from the power supply before cleaning.</p>

Disconnect the RESISTOMAT® 2311 from the power supply and use a dry cloth to clean it.

	NOTICE
	<p>Do not immerse the RESISTOMAT®2311 in water or hold it under running water. Do not use strong cleaning agents as these may damage the instrument. Use a damp cloth to clean the device.</p>

2.5 Personnel

Qualified personnel are persons who, due to their training, experience, instruction and knowledge of the relevant standards, regulations, accident prevention rules and working conditions have been authorized by the person responsible for the safety of the machine/product to carry out the relevant activities and are therefore able to recognize and avoid potentially dangerous situations (for the definition of *Fachkräfte* (competent persons) see VDE 0 105 or IEC 364, which also specify that unqualified persons must not be employed). Knowledge of first aid and the local emergency medical services organization is also required.

Transportation, assembly, installation, putting into service, maintenance and repairs must be carried out by qualified personnel or checked by a responsible competent person.

burster is happy to provide your operating personnel with training. To find out more, please look at our range of services at www.burster.de

2.6 Contents of pack

The following components are supplied:

- RESISTOMAT® model 2311
- Test certificate
- 1x power cable
- Operation manual to download from our website: <https://www.burster.com/en/measure-test-devices/microohm-and-milliohm-meter/p/detail/resistomatr-2311>
- Free version of the DigiControl configuration and analysis software to download from our website: <https://www.burster.com/en/measure-test-devices/microohm-and-milliohm-meter/p/detail/resistomatr-2311>

2.7 Unpacking

	 DANGER
	Electric shock hazard! Never switch on the device if it shows signs of damage incurred in transit. Only ever use the device under the conditions specified in this operating manual.

Inspect the device for damage. If you suspect that the device has been damaged during shipping, notify the delivery company within 72 hours.

The packaging should be retained for examination by a representative of the manufacturer and/or the delivery company.

The RESISTOMAT® 2311 should be shipped only in its original packaging or in packaging capable of providing an equivalent degree of protection.

2.8 Warranty

burster präzisionsmesstechnik gmbh & co. kg provides a manufacturer's warranty for a period of 24 months after delivery.

Any rectification of defects / repairs required during this time will be carried out without charge. This does not include damage arising from improper use.

Please note the following when sending the device in for repair:

- If there is a problem with the device, please attach a note to the body of the device summarizing the fault.
- Technical specifications subject to change at any time without notice. We also state explicitly that we do not accept liability for consequential damage.
- The RESISTOMAT® model 2311 should be shipped only in its original packaging or in packaging capable of providing an equivalent degree of protection.

2.9 Conversions and modifications

Note: The warranty shall be deemed void **immediately** if you open or dismantle the RESISTOMAT® 2311 during the warranty period.

The RESISTOMAT® 2311 does not contain any parts that are intended to be serviced by the user. Only the manufacturer's own qualified personnel are permitted to open the RESISTOMAT® 2311.

It is not permitted to make any changes to the RESISTOMAT® 2311 without the written agreement of burster präzisionsmesstechnik gmbh & co. kg. burster präzisionsmesstechnik gmbh & co. kg does not accept liability for damages or injury if this condition is disregarded.

2.10 Using the device for the first time

If condensation has formed on the device, make sure that the device is completely dry (including inside) before switching it on.

Connect the device to a standard grounded power outlet using the power lead supplied.

2.10.1 Setup and installation, storage

- Ensure sufficient air circulation (prevent heat build-up).
- Avoid positioning the device on surfaces such as carpets, blankets or near materials that could impede air circulation.
- Operate only in a horizontal position.
- Keep the device away from devices, machinery and equipment that generate strong magnetic fields.
- When transporting the device from warm to cold, condensation may form inside the device. Wait a few hours before switching on the device.
- Make sure that the display is not mechanically stressed.
- Do not install in a location where the unit is exposed extreme temperatures or temperature fluctuations, moisture or adverse industrial environments.
- If the device is to be stored for an extended period of time, it should be packed together with a desiccant in an airtight polyethylene bag. Pay attention to the specified storage temperature range.

2.11 Error messages when the unit is powered up

During boot-up, the RESISTOMAT® 2311 may display error messages.

The following errors mean that the RESISTOMAT® 2311 must be sent in for checking and possibly repair:

German error message	English error message
Nichtflüchtige Daten korrupt	Non-volatile data error
Abgleich Fehler	Calibration error
EEPROM von Analogplatine ist leer	EEPROM of analog board is empty
Fehler beim Lesen der MAC Adresse	MAC Address Reading Error

In these cases, please contact our customer service department on +49 7224 645-53, or email service@burster.de (in Germany only). In other countries please contact your local representative (see also www.burster.com).

Please refer to the additional guidance on packaging in section 2.7 “Unpacking” on page 13.

If any of the following error messages occur, you must contact our customer service department (in Germany only). If you are outside Germany, you should contact local burster representative (see also www.burster.com).

German error message	English error message
Analogplatine wurde getauscht	Analog board has been exchanged
Fehler beim Lesen der Seriennummer	Serial Number Reading Error

For further information, please refer to section 2.2 "Customer Service" on page 10.

3 Device concept

Please refer to the current data sheet for the RESISTOMAT® 2311 for full details of dimensions, weight, degree of protection etc. You can find this and other related information on the [product page](#).

3.1 Functional scope

The RESISTOMAT® 2311 uses the 4-wire measuring method (Kelvin measuring method) to precisely measure and evaluate the ohmic resistances of test objects with and without an inductive component in partially or fully automated production processes, laboratory applications, functional tests and at manual workstations. With the RESISTOMAT® model 2311, the operating modes R (purely ohmic), Z (inductive), cooling curve or MIN/MAX can be selected depending on the test object.

The electrical measurand of ohmic resistance, with and without an inductive component, is measured within a very short time and can be qualified by comparators or limit values. A switchable temperature compensation function allows the influence of temperature on the test object to be taken into account, and corrects the measured value.

Upon completion of the internal measurement and qualification, the measured value and the qualification result are shown on the color display, and made available at the external communication and control interfaces. A powerful real-time operating system optimizes processes in the RESISTOMAT® 2311 to achieve an extremely fast evaluation cycle. It typically takes just **approx. 11 - 15 ms** to deliver the global OK or NOK evaluation result, depending on the selected measurement procedure, which can then be analyzed by a higher-level controller.

As well as the classic limit value function, 2-way or 4-way, you can also classify the resistance values (>>; >; = ; <; <<), carry out dry circuit measurements, or display a cooling curve (e.g. of motor windings) with the RESISTOMAT® model 2311.





Abbildung 1: Block diagram of the RESISTOMAT® 2311 display version/

3.2 Versions

Please refer to the data sheet for details of the different versions. The current data sheet and other related information on the RESISTOMAT® 2311 can be found at [data sheet 2311](#).

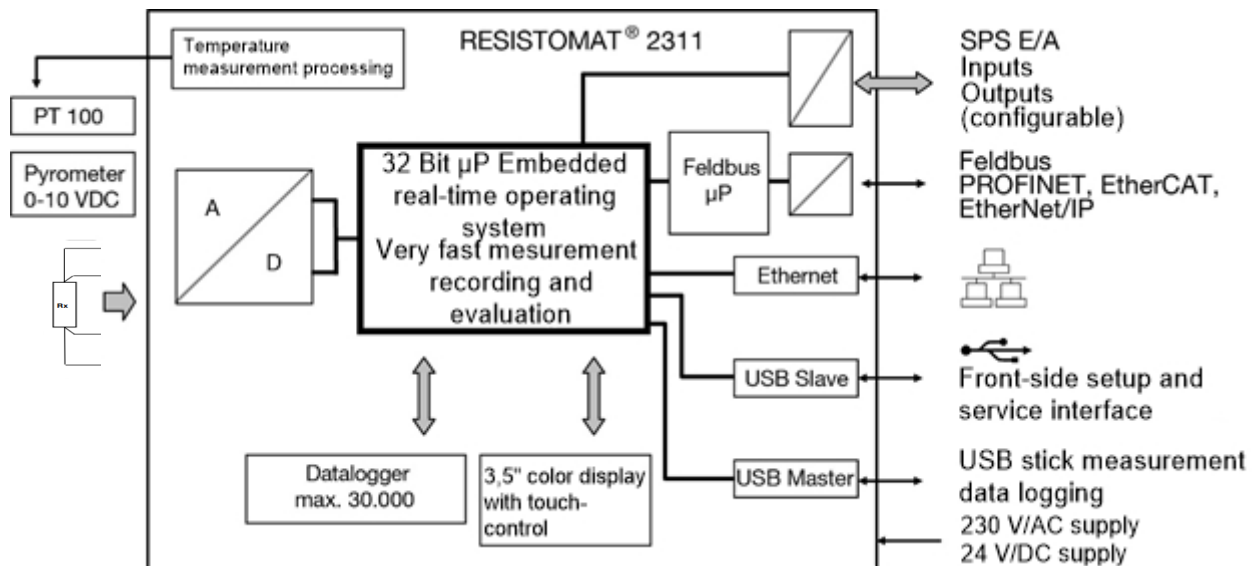
3.3 Power supply

The RESISTOMAT® 2311 desktop device V0XXX can be operated with a voltage of 100 to 240 V AC ($\pm 10\%$) / 50 to 60 Hz ($\pm 10\%$) / typically 15 VA. The RESISTOMAT® 2311 24 V/DC variants V1xxx & V2xxx can be operated with a voltage of 20 ... 30 V/DC (nominal value 24 V/DC).

	 DANGER
	<p>Electric shock hazard!</p> <p>Inspect the power cable for damage before use. Do not connect the power cable if there are signs of damage.</p> <p>To help identify damage to the power lead in good time, test it regularly in accordance with national accident prevention regulations.</p>

4 Controls and connections

4.1 Front panel





Abbildung 2: Front view of the RESISTOMAT® 2311

Item	Description
1	Touchscreen display
2	User-definable function keys [F1] to [F3]
3	Settings ("Configuration Main Menu")
4	Front panel USB service port

Tabelle 1: Front panel items

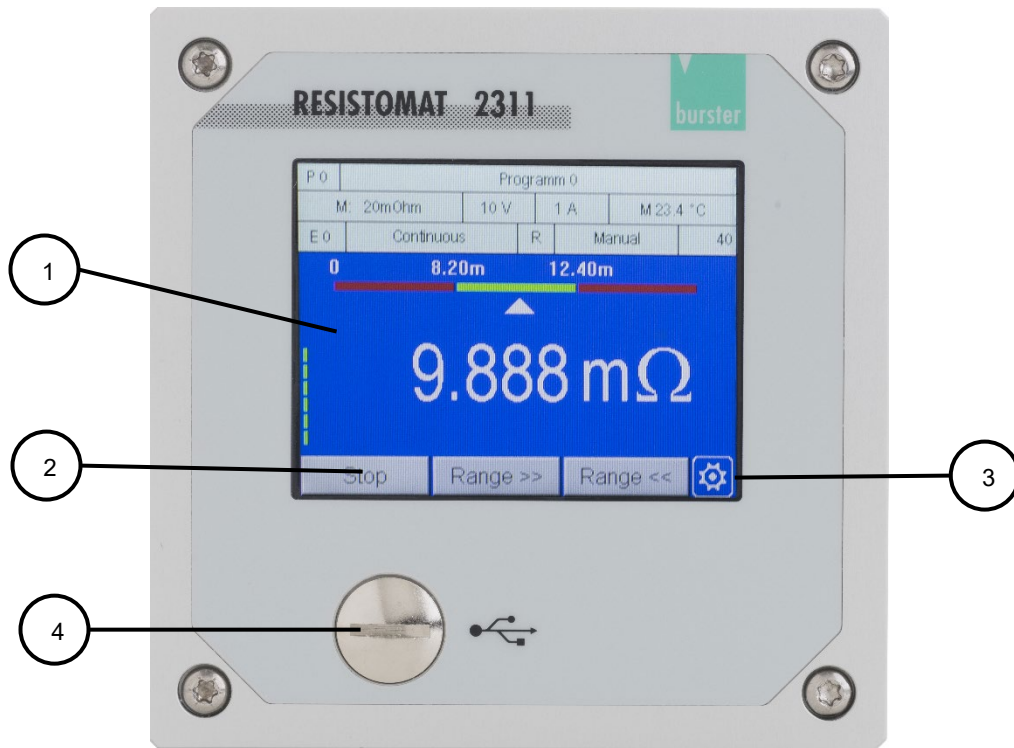
Note: You can choose to have the function keys and the  icon displayed permanently or temporarily in measurement mode. For further information, see section 6.1.1 „Function Key Defination“ on page 34.

4.2 Rear panel



Abbildung 3: Rear view of the RESISTOMAT® 2311

Item	Description
5	Power connection
6	Power switch
7	N/C including LED – not used
8	Ethernet-based fieldbus ports (optional)
9	PLC I/O signals
10	External multiplexer port
11	Measurement input; resistance and 0-10 V DC input for pyrometer
12	Rear USB port (USB host port)
13	Ethernet port
14	Pt100 sensor connection

Tabelle 2: Rear connections

Note: The LEDs for the fieldbus interfaces are described in the relevant supplementary documentation (e.g. 2311 PROFINET) on our website under "[DATA SHEET & DOWNLOADS](#)".

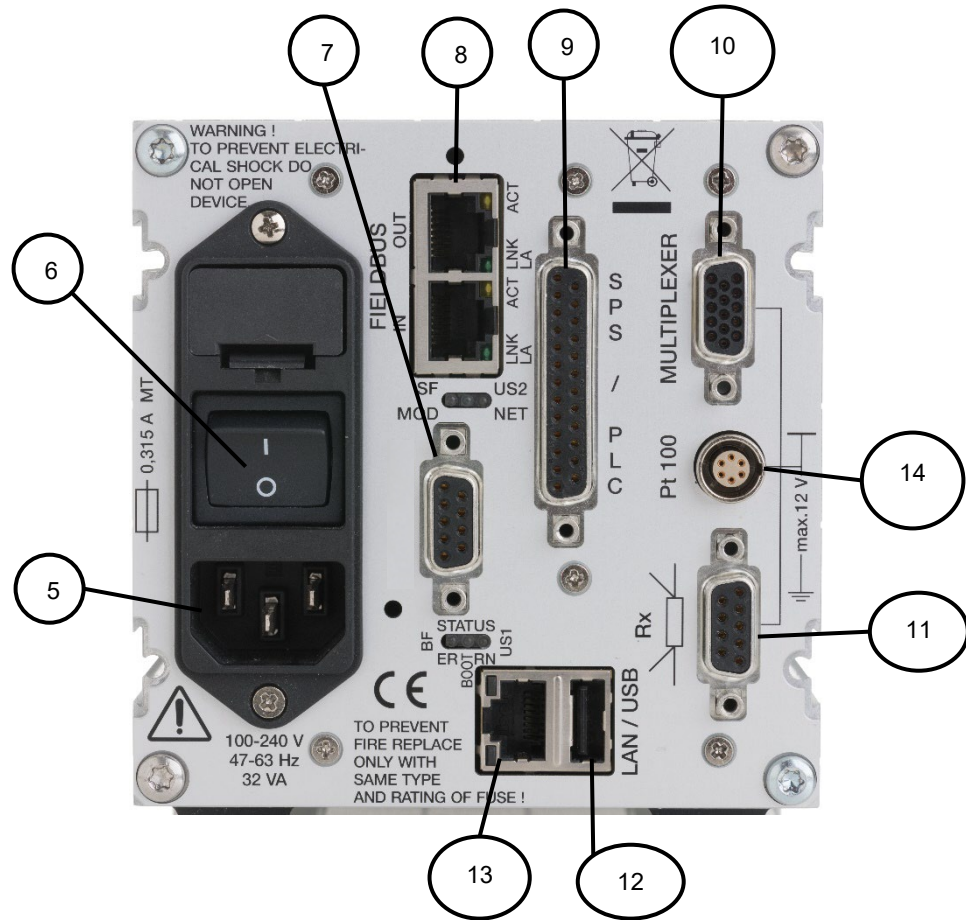
4.3 Touch operation

The RESISTOMAT® 2311 has a touchscreen display. You can tap or swipe the touchscreen to perform control actions.

Touch control options





Action	Description	Symbol used in the operating manual
	Tap the relevant point on the touchscreen with your finger.	
	Swipe your finger downwards or upwards on the touchscreen.	
	Swipe your finger to left or right on the touchscreen.	

Tabelle 3: Touch operation

4.4 Controls and symbols

The following control elements and icons occur repeatedly in the RESISTOMAT® 2311:





Symbol	Meaning
	This icon opens the "Configuration Main Menu".
	This icon always takes you back to the previous menu. Note: The settings you have made are usually applied.
	You can choose to tap on the scroll bar or swipe ▼▲ the scroll bar to reach other menu pages.
[ENTER]	Use this button to confirm your selection.
[ESC]	Use this button to leave the selection menu.
[OK]	Use this button to confirm the data you have entered via the keypad.
[+] / [-]	Use these buttons to increment / decrement any settings.
<input checked="" type="checkbox"/> / <input type="checkbox"/>	Checkbox enabled / disabled.
<input checked="" type="radio"/> / <input type="radio"/>	Radio button enabled / disabled.
	Padlock = "IN_AUTO" control signal = 1 (active). The RESISTOMAT® 2311 is kept in measurement mode and access to the configuration level is locked.

Tabelle 4: Controls and symbols

4.5 Grounding, shielding and connection wiring

The RESISTOMAT® 2311 is earthed (grounded) via the PE conductor of the IEC cold connector (Class I appliance).

In compliance with EN 61010-1, exposed parts that become live in the event of a fault are earthed (grounded). This prevents such parts from carrying hazardous voltages.

In addition, we strongly recommend

- When using control lines from remote PLC systems, make sure all the system components are suitably grounded.
- Position signal lines away from power supply lines (in particular when laying cables near servomotors).
- Preferably use the recommended burster test leads to connect test objects. The test lead must be connected in accordance with regulations and must not be exposed to mechanical disturbance or electrical interference.
- Use a suitable connecting cable with a dual-shield construction (aluminum foil plus braided shield) for the communication and fieldbus interfaces and for the PLC I/O signal control lines.
- Ensure that cable lengths are kept to the minimum required.
- Only connect sensors with shielded cables to the Pt100 connection. If the grounding on the sensor is unknown, the cable shield should not be connected to the connector housing, as this can cause measurement errors due to double grounding stray currents.
- When using power cables from other manufacturers or a mains connection outside Germany, you must ensure that there is a proper connection to ground.

4.6 Connections

4.6.1 PLC I/O signals

	<h2 style="margin: 0;">NOTICE</h2>
	<p>+24 V DC supply voltage Only connect devices that are designed for this supply voltage.</p>

The PLC control signals (inputs and outputs) are provided on the RESISTOMAT® 2311 at the 25-way D-SUB port. The signals are isolated from the controller core and work with positive logic. An external 24 V DC supply is needed to operate the PLC outputs; the RESISTOMAT® 2311 does not provide an auxiliary voltage.

The PLC outputs of the RESISTOMAT® 2311 use sourcing logic (p-switching).



Abbildung 4: PLC output

Pin assignment for the 25-way D-SUB socket (female)

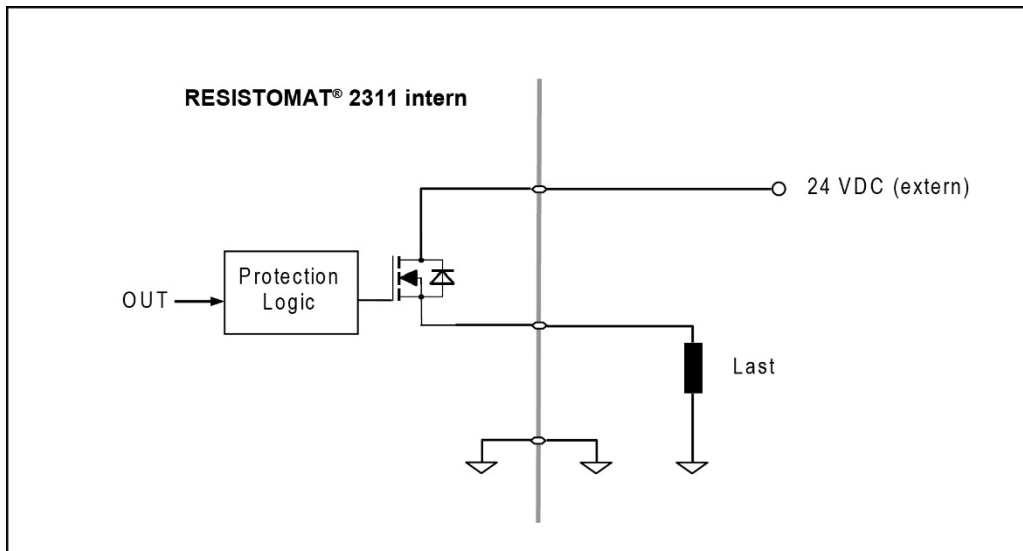

Abbildung 5: 25-way D-SUB socket (female)

Note: Note that some PLC inputs and some PLC outputs have a configurable pin assignment (for further details, see section 6.1.2 “PLC outputs” on page 35 and section 6.1.3 “PLC inputs” on page 37). The following pin assignment is the factory setting.

Pin	Signal name	Configurable	Meaning
1	+24 VDC	-	24 V DC external supply voltage
2	GND_EXT	-	PLC-GND reference potential +24VDC_EXT
3	IN_START	No	Start/stop external measurement
4	IN_AUTO	Yes	RESISTOMAT stays in measurement mode
5	IN_RES_STAT	Yes	Reset the statistics
6	IN_ACK_ERR	Yes	Acknowledgment signal for OUT_ERROR
7	IN_STROBE	Yes	Adopt the measurement program no. from IN_PROG[]
8	IN_PROG0	No	Bit 0 of measurement program no. (binary coded)
9	IN_PROG1	No	Bit 1 of measurement program no. (binary coded)
10	IN_PROG2	No	Bit 2 of measurement program no. (binary coded)
11	COMP_START	Yes	Start/stop comparator
12	IN_PROG3	No	Bit 3 of measurement program no. (binary coded)
13	RESERVED	-	RESERVED
14	OUT_READY	Yes	Ready signal for measurement
15	OUT_MEAS_END	Yes	End of measurement
16	OUT_MEAS_ERR	Yes	Measurement error
17	OUT_STROBE	Yes	Acknowledgment signal for measurement program selection
18	OUT_PROG0	Yes	Bit 0 of echoed measurement program
19	OUT_PROG1	Yes	Bit 1 of echoed measurement program
20	OUT_PROG2	Yes	Bit 2 of echoed measurement program
21	OUT_PROG3	Yes	Bit 3 of echoed measurement program
22	OUT_ERROR	Yes	Fault/error: Possible causes: Measurement started when READY = 0, error during USB logging
23	OUT_COMP_=	Yes	Comparator evaluation: good
24	OUT_COMP_<	Yes	Comparator evaluation: too low
25	OUT_COMP_>	Yes	Comparator evaluation: too high
Housing	Shield (ground)	-	

Tabelle 5: Pin assignment 25-way D-SUB socket (female)

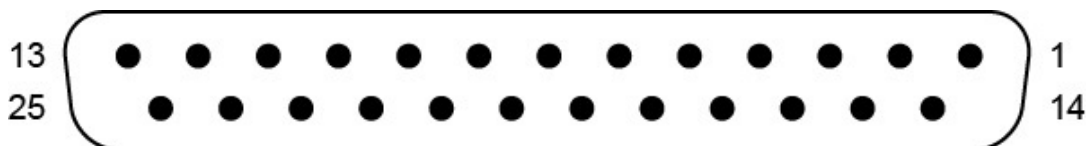
4.6.2 Measurement input



Abbildung 6: Rx and pyrometer measurement input

Pin	Meaning
1	Measurement current I+
2	Measurement current I+ (sensor lead)
3	External measurement start signal
4	Measurement current I- (sensor lead)
5	Measurement current I-
6	Measurement input U+
7	0...10 V DC pyrometer input
8	External measurement start reference
9	Measurement input U-
Housing	Shield (ground)

Tabelle 6: Pin assignment Rx and pyrometer measurement input

4.6.3 Connection: Pt100 sensor

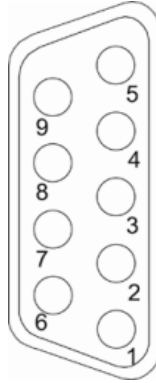
You can connect Pt100 sensors to the built-in 6-pin socket, size 1B LEMO.



Abbildung 7: Pt100 connection

Pin	Meaning
1	Measurement input U+
2	Measurement current I+
3	Measurement current I-
4	Analog GND
5	Analog GND
6	Measurement input U-
Housing	Shield/DGND

Tabelle 7: Pt100 pin assignment

4.6.4 External multiplexer port

The 15-pin D-SUB HD socket is intended for connecting a burster-specific series 2600 multiplexer.



Abbildung 8: Multiplexer port

Pin	Meaning
1	+5 VD
2	EXT_CS_P
3	DGND (connected to connector housing)
4	EXT_CS_N
5	Analog GND
6	EXT_SCK_P

7	TEDS
8	DGND (connected to connector housing)
9	DGND (connected to connector housing)
10	UA_MON
11	EXT_SCK_N
12	EXT_SDO_P
13	EXT_SDO_N
14	EXT_SDI_P
15	EXT_SDI_N
Housing	Shield/DGND

Tabelle 8: External multiplexer pin assignment

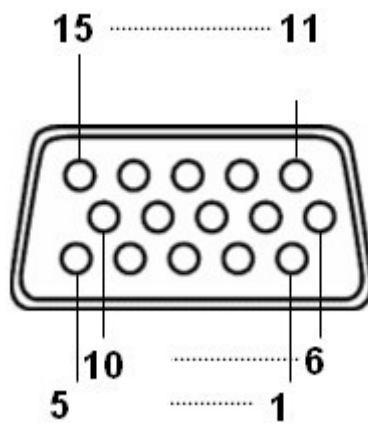
4.6.5 USB service port



Abbildung 9: Front panel USB service port

The USB service port (Micro-B) is located on the front of the instrument behind the screw-in cover. The enhanced IP degree of protection is only provided when the screw-in cover is closed.

You can use the USB service port to configure all settings for the RESISTOMAT® 2311 and to retrieve all measurement and evaluation results including the complete set of measurement curves. The RESISTOMAT® 2311 and DigiControl PC software **Fehler! Textmarke nicht definiert.** (order no. 2311-P100 for PLUS version) can communicate with each other via the USB service port. Use a USB-A plug to Micro-B connecting cable (burster part number 9900-K358, length 1.8 m) to connect to a PC USB port.

The protocol specification for the USB service port is provided in a separate document: the “RESISTOMAT® 2311 interface manual” on the [product page](#).

Note: When the front panel USB service port is in use, IP30 protection of the desktop version is no longer provided. We therefore recommend using this USB service port on a temporary basis only.

4.6.6 Ethernet port

You can use the Ethernet port to configure all settings for the RESISTOMAT® 2311 and to retrieve all measurement and evaluation results including the data logger values. The RESISTOMAT® 2311 and DigiControl PC software (order no. 2311-P101 or 2311-P100 PLUS version) can communicate with each other via the Ethernet port. You can specify Ethernet port parameters such as the IP address in the “Basic Setup” menu.

Use a standard patch cable of category “Cat5e” or above for connecting to an Ethernet network.

The protocol specification for the Ethernet port is provided in a separate document: the “RESISTOMAT® 2311 interface manual” on the [product page](#).

4.6.7 USB host port (memory stick data logging)

The USB host port (USB type A) is located on the rear of the instrument. When you plug in a USB stick and enable data logging, an entry containing results data (but not the measurement curve) is made in the plain-text *.csv file for each measurement (you can find further details in section 6.1.10 “USB Memory” on page 44).



4.6.8 Ethernet-based fieldbus interface (dual RJ-45)

Details of the available Ethernet-based fieldbus interfaces are provided in a separate document (can be requested from info@burster.de or call +49 7224-645-0).

4.6.9 Device power plug

IEC 60320 compliant C13/C14 cold connector plug.

5 Using the device for the first time

	 DANGER
	<p>Electric shock hazard!</p> <p>Never switch on the RESISTOMAT® 2311 if it shows signs of damage incurred in transit. Only ever use the RESISTOMAT® 2311 under the conditions specified in this operating manual.</p>

5.1 Panel mounting

	NOTICE
	<p>Excessive tightening torque may result in damage. Overtightening may damage the mounting profiles.</p> <p>Use the supplied screws to precut the thread. Minimum depth to the stop surface of the mounting profile. Do not exceed a torque of 0.7 Nm when tightening the screws "F" with precut thread.</p>

5.1.1 Panel mounting



Abbildung 10: Panel mounting RESISTOMAT® 2311

Item	Description
A	RESISTOMAT® model 2311
B	Panel cutout
C	Self-adhesive feet (remove before fitting)
D	Instrument panel
E	Mounting profiles (x4)
F	Self-tapping Torx screws (x4) M4x20

Tabelle 9: Panel mounting terms

5.1.2 Panel cutout

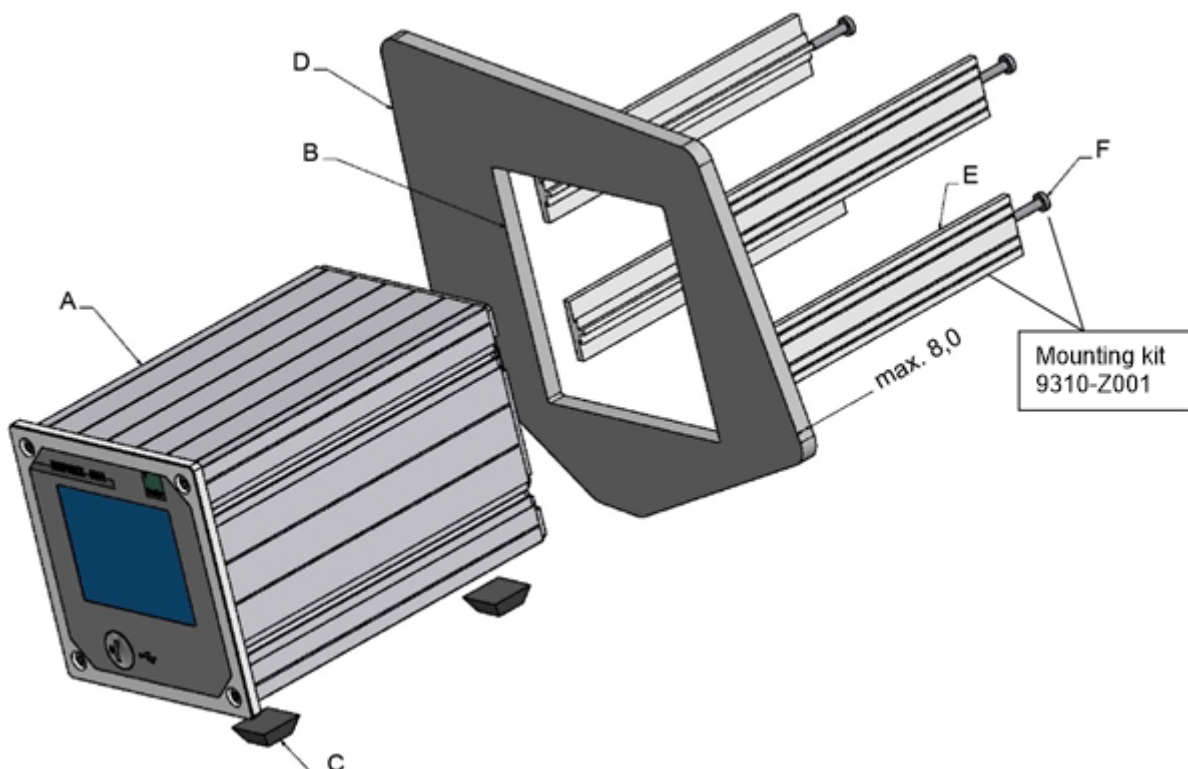



Abbildung 11: Panel cutout RESISTOMAT® 2311

5.2 User language and diagnostics

Immediately after power-up, the RESISTOMAT® 2311 runs a self-test for about 5 seconds. During this self-test, you have the chance to change the user language or go directly to the “Diagnostics” menu (M44) if you wish. The set user language is displayed as a national flag in the top right of the screen during the self-test.

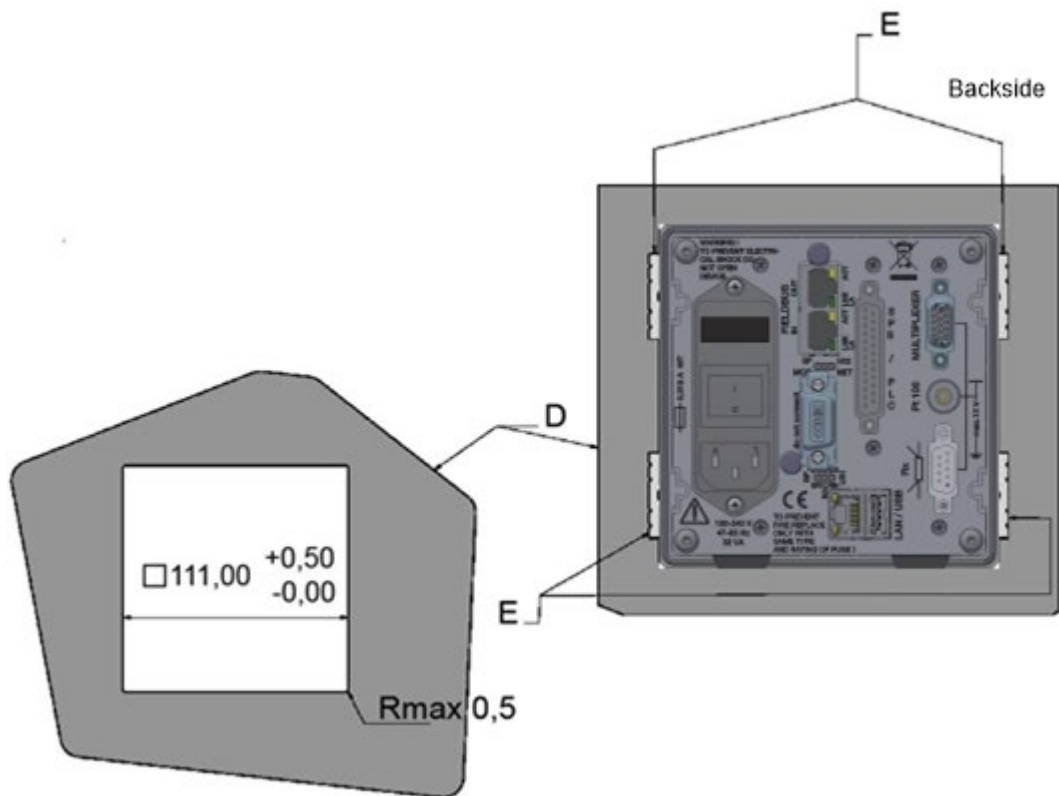

This is how it works

- 1 Switch on the device at the mains switch.
- 2 After a short boot-up phase, the self-test starts running. To set the user language, tap on either **[Config]** or the flag in the top right corner.
- 3 Tapping **[Config]** takes you directly to the “Configuration Main Menu”.
- 4 Tap the “Basic Setup” icon.
- 5 Tap the “Language” icon.
- 6 Tap the displayed flag.
- 7 Select the flag for the language you require.
- 8 To return to the measurement mode, tap 3x .

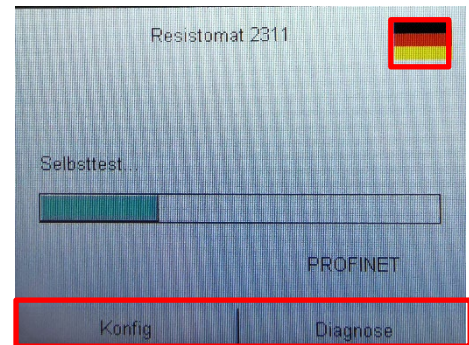



Point 2: To go directly to the “Diagnostics” menu, tap **[Diagnostics]**.

6 Device configuration – “Configuration Main Menu”

The settings for the RESISTOMAT® 2311 are configured via the “Configuration Main Menu” (M3).



This is how it works

- 1 Once powered up, the RESISTOMAT® 2311 enters measurement mode directly; to access the configuration settings for the device, touch anywhere on the touchscreen. The  icon appears in the bottom right corner.
- 2 Tap  to open the “Configuration Main Menu”.

Note: You can choose to display the  icon permanently in measurement mode. For further details, see section 6.1.1 „Function Key Definition on page 34.

Menu structure





Abbildung 12: Menu structure RESISTOMAT® 2311

Note: Simply tap  several times from any submenu to return to measurement mode.

IMPORTANT: Access to the configuration level may be blocked in the following cases:

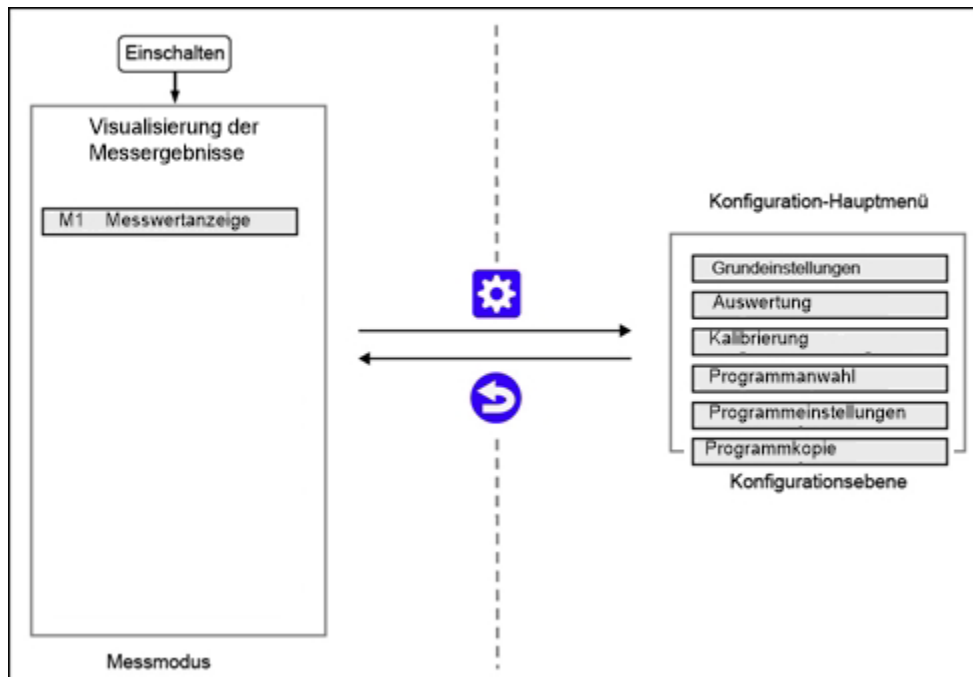
- PLC control signal “IN_AUTO” = 1.
- Access protection is enabled (please see section 6.1.4 “Access Permissions” on page 38).
- DigiControl measurement mode is active (automatic logging of measurement data by the DigiControl PC software).

Configuration Main Menu (M3)

The following submenus are available in the “Configuration Main Menu” (M3):



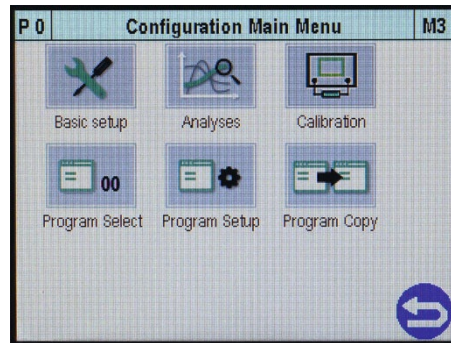









- Basic Setup
- Evaluation
- Calibration
- Program Selection
- Program Setup
- Copy Programs



6.1 Basic Setup

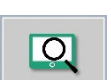

The “Basic Setup” menu (M4) contains all the settings that do not relate specifically to measurement programs.

You can edit or view the following settings and information in the “Basic Setup” menu (M4):

	Function key assignments		PLC outputs		PLC inputs
	Access permissions		Info		
	LCD settings		Date and time		Language
	Interfaces		USB memory		Diagnostics
	Order sheet				



This is how it works

- 1 To open the “Basic Setup” menu from measurement mode, tap anywhere on the touchscreen. The  icon appears in the bottom right corner.
- 2 Tap  to open the “Configuration Main Menu”.
- 3 Tap the “Basic Setup” icon.

Note: You can choose to display the  icon permanently in measurement mode. For further details, see section 6.1.1 “Fuction Key Definition” on page 34.

6.1.1 Function Key Definition

The “Function Key Definition” menu (M20) lets you customize the three function keys displayed in measurement mode, and to select whether they are displayed permanently or only temporarily for 5 seconds.



The following functions can be assigned:

Item	Meaning
Off	Not used
Start/Stop	Start a measurement / stop a measurement
Program >>	Switch to the next program in measurement mode
Program <<	Switch to the previous program in measurement mode
End Load	End Load Cooling Curve
Range >>	Switch to the next larger measuring range in measurement mode (Only possible with manual range selection)
Range <<	Switch to the next smaller measuring range in measurement mode (Only possible with manual range selection)

Tabelle 10: Meaning of the function keys



This is how it works

- 1 In measurement mode, tap anywhere on the touchscreen. The  icon appears in the bottom right corner.
- 2 Tap  to open the “Configuration Main Menu”.
- 3 Tap the “Basic Setup” icon.
- 4 Tap the “Function Keys” icon.
- 5 Tap the function key (F1, F2, F3) that you want to assign.
- 6 Select the function that you want to assign then confirm with **[ENTER]**.
- 7 If you want to change how long the function keys are displayed, tap “Display mode”.
If “Always on” is enabled, then the function keys are permanently displayed in measurement mode.
If “Fade out” is enabled, then you can display the function keys for 5 seconds in measurement mode by tapping anywhere on the touchscreen.
- 8 Tap  to return to the “Basic Setup” menu.

6.1.2 PLC Outputs

In the “Assignment of the PLC Outputs” menu (M21), you can customize which signals appear at certain PLC outputs. Pin 13 cannot be changed.



You have the option to assign a different signal to pins 14 to 25 from the following:

OUT_READY	Ready signal for measurement
OUT_MEAS_END	End of measurement
OUT_MEAS_ERR	Measurement error
OUT_STROBE	Acknowledgment signal for measurement program selection
OUT_PROG0	Bit 0 of echoed measurement program
OUT_PROG1	Bit 1 of echoed measurement program
OUT_PROG2	Bit 2 of echoed measurement program
OUT_PROG3	Bit 3 of echoed measurement program
OUT_PROG4	Bit 4 of echoed measurement program
OUT_ERROR	Fault/error Possible causes: <ul style="list-style-type: none"> • Measurement started when READY = 0 • Error during USB logging • Device error during boot-up
OUT_COMP_>>	Comparator evaluation too low
OUT_COMP_>	Comparator evaluation low
OUT_COMP_=	Comparator evaluation good
OUT_COMP_<	Comparator evaluation high
OUT_COMP_<<	Comparator evaluation too high
OUT_AUX0	Reserved
OUT_AUX1	Reserved
OUT_AUX2	Reserved
OUT_AUX3	Reserved

Tabelle 11: Possible pin assignments 14-25



This is how it works

- 1 In measurement mode, tap anywhere on the touchscreen. The  icon appears in the bottom right corner.
- 2 Tap  to open the “Configuration Main Menu”.
- 3 Tap the “Basic Setup” icon.
- 4 Tap the “PLC Outputs” icon.
- 5 To open the second page of the menu, tap the bottom of the scroll bar.
- 6 Tap the name of the pin that you wish to reassign.
- 7 Select the signal that you wish to assign then confirm with **[ENTER]**.
- 8 Repeat steps 4 and 5 for all the pins that you wish to reassign.
- 9 Tap  to return to the “Basic Setup” menu.

6.1.3 PLC Inputs

In the “Assignment of the PLC Inputs” menu (M22), you can customize which signals are assigned to certain PLC inputs. You cannot change the settings for pins 3, 8 to 10 and 12.

You have the option to assign a different signal to pins 4 to 7 and 11 from the following:



Signal	Description
IN_AUTO	RESISTOMAT® 2311 is kept in measurement mode
IN_RESET_STAT	Reset the statistics
IN_STROBE	Adopt the measurement program no. from IN_PROG[]
IN_ACK_ERROR	Acknowledgment signal for OUT_ERROR
IN_COMP_START	Start/stop comparator
IN_MAX_MIN_START	Start/stop max/min function
IN_LOGGER_START	Start/stop data logger
IN_END_LOAD	End load cooling curve
IN_AUX0	Reserved
IN_AUX1	Reserved
IN_AUX2	Reserved
IN_AUX3	Reserved

Tabelle 12: PLC input signal explanations

Note: If the RESISTOMAT® 2311 has a permanent error, the “OUT_ERROR” output cannot be reset by acknowledging the error.



This is how it works

- 1 In measurement mode, tap anywhere on the touchscreen. The  icon appears in the bottom right corner.
- 2 Tap  to open the “Configuration Main Menu”.
- 3 Tap the “Basic Setup” icon.
- 4 Tap the “PLC Inputs” icon.
- 5 Tap the name of the pin that you wish to reassign.
- 6 Select the signal that you wish to assign then confirm with **[ENTER]**.
- 7 Repeat steps 3 and 4 for all the pins that you wish to reassign.
- 8 Tap  to return to the “Basic Setup” menu.

6.1.4 Access Permissions

You can make the following settings in the “Access Permissions” menu (M23):

- Define/change a master password
- Define/change a user password
- Enable/disable password protection
- Specify access levels for master/user
- Block/unblock access by DigiControl.



Factory-set master password: **2609**

Factory-set user password: **2201**

6.1.4.1 Changing the master/user password



This is how it works

- 1 In measurement mode, tap anywhere on the touchscreen. The  icon appears in the bottom right corner.
- 2 Tap  to open the “Configuration Main Menu”.
- 3 Tap the “Basic Setup” icon.
- 4 Tap the “Access” icon.
- 5 Tap “Master Password” and enter the current password via the keypad.
- 6 Tap **[OK]**.
- 7 Tap “New Master Password” and enter the new password you require via the keypad.
- 8 Tap **[OK]**.
- 9 Tap “User Password” and enter the current password via the keypad.
- 10 Tap **[OK]**.

6.1.4.2 Specifying access levels for master/user

The RESISTOMAT® 2311 lets you manage master/user access levels. When password protection is enabled, you can lock specific configuration levels for the currently logged-in user. A master assumes the role of an administrator for the device and has access rights to all levels. A master is also able to set the permissions for the user and a user password.

The following levels can be locked/unlocked for the logged-in user:

- Basic Setup
- Program Selection
- Copy Programs
- Measurement Method
- PLC Test
- External Storage
- Comparator
- Max / Min
- Temp. Comp.
- Pt100
- U Input
- Meas. Val. Disp.
- Max / Min Evaluation
- Comparator Evaluation
- Data Logger Evaluation
- Cooling Curve

- Data Logger
- Calibration



This is how it works

- 1 After entering the master password, tap “Password Protection” to enable this option.
- 2 Tap “Access Levels”.
- 3 Select the access levels that you want to lock.
- 4 Tap  to return to the “Access Permissions” menu.

6.1.4.3 Blocking/unblocking access by the DigiControl PC software

In the “Access Permissions” menu (M23), with password protection enabled you also have the option to block the DigiControl PC software from making changes to the device configuration. To do this, disable the “Access DigiControl” checkbox (even with password protection enabled, the default setting is to allow access by the DigiControl PC software).



This is how it works



- 1 Tap the checkbox to allow or block access by DigiControl.
- 2 Tap  to return to the “Basic Setup” menu.

6.1.5 Device Information

The “Device Information” menu (M24) contains information about the device, including serial number, software version, bootloader version, calibration date and fieldbus card. You can also enter a station name here.



This is how it works



- 1 In measurement mode, tap anywhere on the touchscreen. The  icon appears in the bottom right corner.
- 2 Tap  to open the “Configuration Main Menu”.
- 3 Tap the “Basic Setup” icon.
- 4 Tap the “Info” icon.
- 5 Tap “Station Name” and enter the desired name via the keypad.
- 6 Tap [OK].
- 7 Tap  to return to the “Basic Setup” menu.

6.1.6 LCD Settings

In the “LCD Settings” menu (M25) you can set the brightness of the touchscreen display in 10 levels.



This is how it works



- 1 In measurement mode, tap anywhere on the touchscreen. The  icon appears in the bottom right corner.
- 2 Tap  to open the “Configuration Main Menu”.
- 3 Tap the “Basic Setup” icon.
- 4 Tap the “LCD Settings” icon.
- 5 Tap **[+]** or **[-]** to step up or step down the brightness.
- 6 Tap  to return to the “Basic Setup” menu.

6.1.7 Date and Time

In the “Date and Time” menu (M26) you can set the date and time.



This is how it works

- 1 In measurement mode, tap anywhere on the touchscreen. The  icon appears in the bottom right corner.
- 2 Tap  to open the “Configuration Main Menu”.
- 3 Tap the “Basic Setup” icon.
- 4 Tap the “Date/Time” icon.
- 5 Tap the text field that you wish to change.
- 6 Make the change via the keypad and tap **[OK]**.
- 7 Tap  to return to the “Basic Setup” menu.

6.1.8 Language



In the “Language Selection” menu (M27) you can set the user language for the RESISTOMAT® 2311.

The following 5 languages are available:



This is how it works

- German
- English
- French
- Italian
- Spanish

- 1 In measurement mode, tap anywhere on the touchscreen. The  icon appears in the bottom right corner.
- 2 Tap  to open the “Configuration Main Menu”.
- 3 Tap the “Basic Setup” icon.
- 4 Tap the “Language” icon.
- 5 Tap the displayed flag.
- 6 Select the flag for the language you require.
- 7 Tap  to return to the “Basic Setup” menu.



6.1.9 Interfaces

In the “Interface Setup (USB/Ethernet)” menu (M28) you can specify the necessary interface parameters.

Note: If the RESISTOMAT® 2311 is being used for live measurement data logging by the DigiControl PC software via one of the two interfaces (USB or Ethernet) (measurement mode), the DigiControl PC software cannot have simultaneous access via the second interface.



This is how it works

- 1 In measurement mode, tap anywhere on the touchscreen. The  icon appears in the bottom right corner.
- 2 Tap  to open the “Configuration Main Menu”.
- 3 Tap the “Basic Setup” icon.
- 4 Tap the “Interfaces” icon.
- 5 Tap the icon for the interface (“USB” or “Ethernet”) for which you want to specify the interface parameters, then make the required settings.
- 6 Tap  to return to the “Basic Setup” menu.

6.1.9.1 USB interface parameters

A PC detects the USB port of the RESISTOMAT® 2311 as a virtual COM port. The drivers needed for this port are installed together with the DigiControl PC software. If you want to use PC communication without the DigiControl PC software, you can download the necessary drivers from www.burster.com.

Parameters in the “Interface Setup (USB/Ethernet)” menu (M37)

Baud rate	921600 (fixed setting)
Data bits	Fixed data format, 8 bits (fixed setting)
Stop bits	Number of stop bits: 1 (fixed setting)
Parity	None (fixed setting)
Blockcheck*	Enabled / disabled

*The separate interface specification provides information on the block check.

Tabelle 13: Parameters in the “Interface Setup (USB/Ethernet)” menu (M37)

6.1.9.2 Ethernet interface parameters

Parameters in the “Ethernet Interface (UDP/IP)” menu (M38)

DHCP	<p>Enabled / disabled</p> <p>When DHCP (Dynamic Host Configuration Protocol) is enabled, the RESISTOMAT® 2311 is assigned an IP address, subnet mask and gateway by the DHCP server.</p>
IP address	<p>Enter the IP address for the RESISTOMAT® 2311 here. You can obtain a valid address from your network administrator.</p> <p>Note: The IP address must be unique within a network.</p>
Subnet mask	<p>Enter the subnet mask here. You can obtain a valid mask from your network administrator. The subnet mask defines whether an IP address lies in the same sub-network.</p>
Gateway	<p>Enter the gateway here. You can obtain a valid address from your network administrator. Connections to other networks can be made via the gateway.</p>
Port	<p>This is where you select the UDP port (default: 7292).</p> <p>Note: If a firewall is used, the UDP protocol must be enabled on this port. On a PC, only one active UDP connection (socket) is allowed on the same port.</p>
Communication	<p>Ethernet communication. Select either “Encoded” or “Encoded and open”.</p> <p>“Encoded”: UDP datagrams are transmitted in encoded form.</p> <p>“Encoded and open”: UDP datagrams are transmitted in encoded and unencoded form.</p>
MAC address	<p>Shows the unique MAC address</p>
Host IP restriction	<p>An active host IP restriction can be used to restrict access to up to three specified host addresses. This can be useful for preventing unwanted access attempts, for example attempts to change the device configuration. The host IP restriction is factory set to disabled.</p>

Tabelle 14: Ethernet interface parameters

6.1.10 USB Memory

When data logging on a USB flash drive is enabled, an entry with result values is made in a file with each measurement. If you have connected a USB stick to the rear USB port on the RESISTOMAT® 2311, the associated information is displayed in the “USB Memory” menu (M29). In this menu, you can also format the USB stick and configure the behavior of the “OUT_READY” control signal.

The following settings can be made in the “USB Memory” menu (M29):

USB Memory	Format the USB stick (file format: FAT32)
READY control	If you enable this function, the Ready status and the “OUT_READY” control signal are not set until data logging on the USB stick has finished.

Note: You need to enable data logging in each measurement program for which you wish to record the measurement data on the USB stick.

Sequence

When data logging on a USB flash drive is enabled, an entry is made in a file with each measurement. A new file is created when USB stick data logging first starts. When the file is created, a “HEADER” is saved in the file. This header is not subsequently checked for plausibility however. The file name, on the other hand, is always checked for validity for subsequent measurements. If it is still valid, the new entry is added to the file. If not, a new file is created. If the file reaches the maximum file size of 25 MB, data is automatically written to a new file.

Storage location	...\\Data\\<YYYY>\\<MM> Key: <YYYY> : year <MM> : month
File type	*.csv (ASCII)
Language	In German or English
File name	<Component_Name>~<Batch>#<Sequential_Number> @<2311_Serial_Number>-<Program_Number>.csv Key: <Component_Name> : Configurable; program name, or component name from order sheet. ~<Batch> : Batch from order sheet; not included if a batch reference is not entered. #<Sequential_Number> : A sequential number with “#” prefix for files with the same name; not used if the file name is unique.
Maximum file size	25 MB

Tabelle 15: Sequence for live USB stick data logging

File structure – HEADER





Note: The “HEADER” is created just once when the file is created, but it is not checked again for plausibility.

The “HEADER” contains the following information:

	A	B
1	HEADER	
2	Gerät	Resistomat 2311
3	Stationsname	ST-A-70
4	Seriennummer	231109211
5	Bauteil	Spule1
6	Programmname	Programm 0
7	Programmnummer	0
8	Charge	Z987654321A
9	Einheit	Ohm
10	Zeitstempel	2023_04_26_09_22_36
11	FW/Protocol vers.	B202204M/1.01



This is how it works

- 1 In measurement mode, tap anywhere on the touchscreen. The  icon appears in the bottom right corner.
- 2 Tap  to open the “Configuration Main Menu”.
- 3 Tap the “Basic Setup” icon.
- 4 Swipe  the touchscreen to open the second page.
- 5 Tap the “USB Memory” icon.
- 6 Tap the row that you wish to change until the setting you require is displayed.
- 7 Tap  to return to the “Basic Setup” menu.

6.1.11 Diagnostics

The “Diagnostics” menu (M30) contains 3 submenus:



Log File



Service Login

The “Log File Analysis” menu (M39) contains the following details: entry number, event, date, time, program number, access authorization and repetitions for each of the 256 log entries.

The following events are recorded in the log file:





- “Resistance value invalid”
- “Current overload”
- “Voltage overload”
- “Temperature measurement error”
- “Zero measurement error” (if zero compensation is active)
- “Data logger, first value”
- “USB memory error”
- “Data logger”

- “Pt100 error”
- “Broken wire”
- “Port, request too early”
- “Temperature too high for 1 A measurement”

The “Service Login” menu is password protected and reserved for employees of burster präzisionsmesstechnik gmbh & co. kg.



This is how it works

- 1 In measurement mode, tap anywhere on the touchscreen. The  icon appears in the bottom right corner.
- 2 Tap  to open the “Configuration Main Menu”.
- 3 Tap the “Basic Setup” icon.
- 4 Swipe   the touchscreen to open the second page.
- 5 Tap the “Diagnostics” icon.
- 6 Tap the relevant icon to display the information you require.
- 7 Tap  twice to return to the “Basic Setup” menu.





6.1.12 Order Sheet

In the “Order Sheet” menu (M31) you can save and retrieve a huge range of background information on the measurement. All entries can be read/written via the available fieldbus interfaces. The DigiControl PC software can optionally retrieve these entries during automatic measurement data logging, and use them to create a reference to admin, operator or component in the measurement report file.

- Name of operator
- Order number
- Batch
- Component name
- Serial number 1
- Serial number 2



This is how it works

- 1 In measurement mode, tap anywhere on the touchscreen. The  icon appears in the bottom right corner.
- 2 Tap  to open the “Configuration Main Menu”.
- 3 Tap the “Basic Setup” icon.
- 4 Swipe   the touchscreen to open the second page.
- 5 Tap the “Order Sheet” icon.
- 6 Tap the row that you want to edit and then enter the required information via the keypad.
- 7 Tap [OK].
- 8 Tap  to return to the “Basic Setup” menu.

6.1.13 EtherCAT settings (option)

Abbildung 13: **Note:** The “EtherCAT” menu (M32) only exists if your RESISTOMAT® 2311 is equipped with option Vxxx1.

Abbildung 14:

Abbildung 15: “Missing screenshot”

Parameters in the “EtherCAT” menu (M32)

Abbildung 16:

6.1.14 PROFINET settings (option)

Note: The “PROFINET” menu (M33) only exists if your RESISTOMAT® 2311 is equipped with option Vxxx3.



Abbildung 17: PROFINET settings – page 1

Parameters in the “PROFINET” menu (M33)

Software version	Firmware version of the PROFINET fieldbus module
Serial number	Serial number of the fieldbus module
Control via	<p>PROFINET: The RESISTOMAT® 2311 responds solely to control signals (inputs) from the PROFINET interface.</p> <p>PLC: The RESISTOMAT® 2311 responds solely to control signals (inputs) from the PLC I/O interface.</p> <p>When control via PLC I/O is selected, data is still transferred on the PROFINET real-time channel.</p>
Device MAC	Address for identifying the fieldbus module in the PROFINET network.
Port1 MAC	Port 1 MAC address
Port2 MAC	Port 2 MAC address

Name of station	The station name assigned by the PROFINET host.
IP address	Assigned IP address Note: This parameter cannot be changed in the RESISTOMAT® 2311.
Subnet mask	Assigned subnet mask Note: This parameter cannot be changed in the RESISTOMAT® 2311.
Gateway	Assigned gateway address Note: This parameter cannot be changed in the RESISTOMAT® 2311.

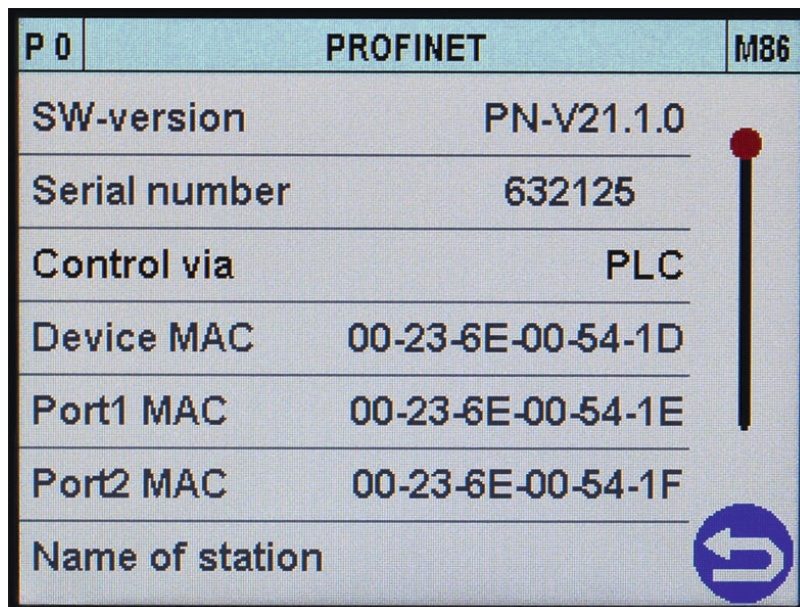
Tabelle 16: Parameters in the “PROFINET” menu

Note: Details of the PROFINET interface are provided in a separate document: the RESISTOMAT® 2311 PROFINET manual on the [product page](#).

6.1.15 EtherNet/IP settings (option)

Note: The “EtherNet/IP” menu (M34) only exists if your RESISTOMAT® 2311 is equipped with option Vxxx4.

Abbildung 18: EtherNet/IP settings

Parameters in the “EtherNet/IP” menu (M77)

Software version	Firmware version of the EtherNet/IP fieldbus module
Serial number	Serial number of the fieldbus module
Control via	EtherNet/IP: The RESISTOMAT® 2311 responds solely to control signals (inputs) from the EtherNet/IP interface. PLC: The RESISTOMAT® 2311 responds solely to control signals (inputs) from the PLC I/O interface. When control via PLC I/O is selected, data is still transferred on the EtherNet/IP real-time channel.
MAC address	Address for identifying the fieldbus module in the EtherNet/IP network.
IP configuration	Network configuration type (BOOTP, DHCP, static) Note: This parameter cannot be changed in the RESISTOMAT® 2311.
IP address	IP address If BOOTP or DHCP is selected for “IP Configuration”, the IP address is assigned by a BOOTP or DHCP server. Note: The IP address cannot be changed by the user if BOOTP or DHCP is selected for the IP configuration mode.
Subnet mask	Subnet mask If BOOTP or DHCP is selected for “IP Configuration”, the subnet mask is assigned by a BOOTP or DHCP server. Note: The subnet mask cannot be changed by the user if BOOTP or DHCP is selected for the IP configuration mode.
Gateway	Gateway address If BOOTP or DHCP is selected for “IP Configuration”, the gateway is assigned by a BOOTP or DHCP server.

	Note: The gateway address cannot be changed by the user if BOOTP or DHCP is selected for the IP configuration mode.
--	--

Tabelle 17: EtherNet/IP menu parameters

Note: Details of the EtherNet/IP interface are provided in a separate document: the RESISTOMAT® 2311 EtherNet/IP manual on the [product page](#).

6.2 Evaluation





In the “Evaluation” menu (M5), you can display the analysis/counters of the various measurement evaluations: Data Logger, Comparator, Max / Min and Cooling Curve.

6.2.1 Data Logger

The individual parameters and measured values of the data logger records stored on the device are displayed in the “Data Logger Evaluation” menu (M40). The data logger function must be activated for this (see section XXXX “Data logger function” (M52) on page XX).



This is how it works



- 1 To open the “Evaluation” menu from measurement mode, tap anywhere on the touchscreen. The  icon appears in the bottom right corner.
- 2 Tap  to open the “Configuration Main Menu”.
- 3 Tap the “Evaluation” icon.
- 4 Tap the “Data Logger” icon.
- 5 Swipe  to view all values of a data record.
- 6 Swipe  to switch between the saved data records.
- 7 Tap on “Delete” and then on **[ENTER]** to delete the saved data records.
- 8 Tap 2x  to return to the “Configuration Main Menu”.

6.2.2 Comparator

The counters for the individual comparator evaluation criteria are displayed in the “Comparator Evaluation” menu (M41). All values can be reset here. The comparator function must be activated for this (see section XXXX “Comparator” (M51) on page XX).





This is how it works

- 1 To open the “Evaluation” menu from measurement mode, tap anywhere on the touchscreen. The  icon appears in the bottom right corner.
- 2 Tap  to open the “Configuration Main Menu”.
- 3 Tap the “Evaluation” icon.
- 4 Tap the “Comparator” icon.
- 5 Tap on “Reset” to reset all counters.

6.2.3 Max / Min

The minimum measured value, the maximum measured value, and the difference between the two measured values are displayed in the “Max / Min Evaluation” menu (M42). All values can be reset here. The Max / Min function must be activated for this (see section 6.5.4 “Max / Min” (M53) on page 68).





**This is how it works**

1. To open the “Evaluation” menu from measurement mode, tap anywhere on the touchscreen. The  icon appears in the bottom right corner.
2. Tap  to open the “Configuration Main Menu”.
3. Tap the “Evaluation” icon.
4. Tap the “Max / Min” icon.
5. Tap on “Reset” to reset all values.
6. Tap 2x  to return to the “Configuration Main Menu”.

6.2.4 Cooling Curve

In the “Cooling Curve Evaluation” menu (M43), the data records of the measured cooling curve are each displayed with numbering, time, and measured value with unit. The cooling curve function must be activated for this (see section 6.5.9 “Cooling curve” (M58) on page 73).

**This is how it works**

- 1 To open the “Evaluation” menu from measurement mode, tap anywhere on the touchscreen. The  icon appears in the bottom right corner.
- 2 Tap  to open the “Configuration Main Menu”.
- 3 Tap the “Evaluation” icon.
- 4 Tap the “Cooling Curve” icon.
- 5 Swipe   to scroll through all data records.
- 6 Tap “Beginning” to jump to the first data record.
- 7 Tap “End” to jump to the first data record.
- 8 Tap “Middle” to jump to the middle of the data records.
- 9 Tap 2x  to return to the “Configuration Main Menu”.

6.3 Calibration

6.4 Program Selection

In the “Program Selection” menu (M7) you can select the measurement program number and give the program a name.

Program number selection

Select the measurement program for which you wish to make specific settings.



The currently active measurement program is always displayed in the top left corner.

Naming the program

Specify a name for the selected measurement program. You can enter this program name in the “Enter program name” dialog box. You can enter up to 20 alphanumeric characters and/or special characters.



This is how it works

- 1 To open the “Program Selection” menu from measurement mode, tap anywhere on the touchscreen. The  icon appears in the bottom right corner.
- 2 Tap  to open the “Configuration Main Menu”.
- 3 Tap the “Program Select” icon.
- 4 Enable the radio button for the program number that you wish to select.
- 5 Tap **[Program X]** for the selected program number to change the program name.
- 6 Use the keypad to enter your required program name and confirm with **[OK]**.
- 7 Tap  to return to the “Configuration Main Menu”.

6.5 Program Setup menu

The “Program Setup” menu (M8) contains all the settings that relate specifically to measurement programs.

You can edit or view the following settings and information in the “Program Setup” menu (M8):

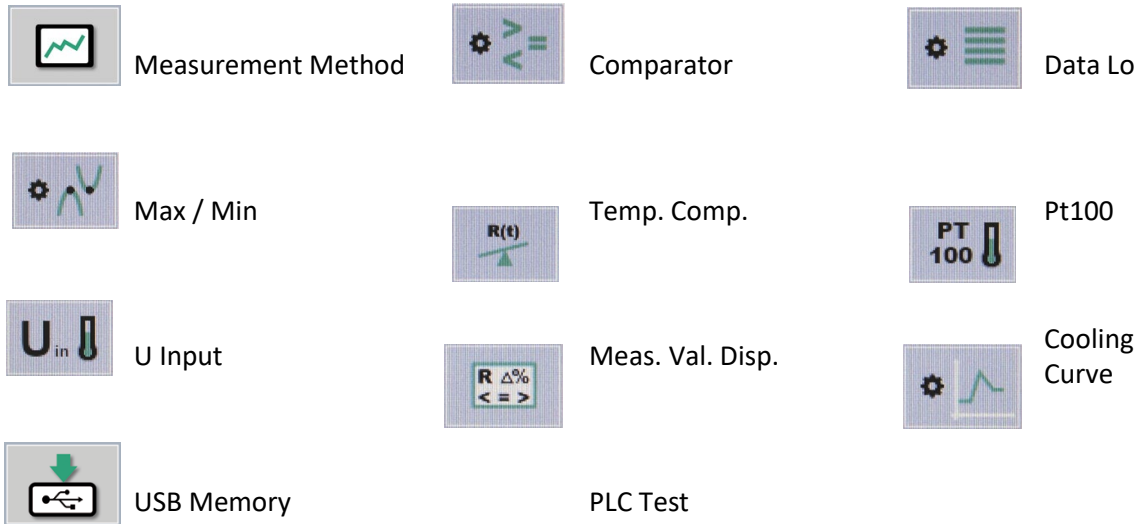



6.5.1 Measurement Method

The basic settings for the measurement procedure are made in the “Measurement Method” menu (M50).



This is how it works



- 1 To open the “Measurement Method” menu from measurement mode, tap anywhere on the touchscreen. The  icon appears in the bottom right corner.
- 2 Tap  to open the “Configuration Main Menu”.
- 3 Tap the “Program Setup” icon.
- 4 Tap the “Measurement Method” icon.

6.5.1.1 Range selection

In the “Range selection” row, you can switch between manual and automatic measuring range selection. In the “Automatic” setting, the device automatically selects the optimum measuring range for the measured value. Automatic range selection only works with the purely ohmic test object setting. “Test object”→“R”. For inductive test objects and when setting time constants Z0-Z3, only manual range selection is available.



This is how it works



- 1 In measurement mode, tap anywhere on the touchscreen. The  icon appears in the bottom right corner.
- 2 Tap  to open the “Configuration Main Menu”.
- 3 Tap the “Program Setup” icon.
- 4 Tap the “Measurement Method” icon.
- 5 Tap on the “Range selection” row to switch between automatic and manual range selection.

6.5.1.2 Measuring range

If manual range selection is selected, you can define the measuring range in the “Measuring range” row. This is also possible in measuring mode using the function keys, provided they have been assigned accordingly.



This is how it works



- 1 In measurement mode, tap anywhere on the touchscreen. The  icon appears in the bottom right corner.
- 2 Tap  to open the “Configuration Main Menu”.
- 3 Tap the “Program Setup” icon.
- 4 Tap the “Measurement Method” icon.
- 5 Tap the “Measuring range” row.
- 6 Select the desired measuring range from the drop-down list and confirm your selection with **[ENTER]**.

6.5.1.3 Minimum and maximum range

If automatic range selection is selected, you can use the “Minimum range” and “Maximum range” rows to set a lower or upper limit for the measuring range that the device selects.



This is how it works

- 1 In measurement mode, tap anywhere on the touchscreen. The  icon appears in the bottom right corner.
- 2 Tap  to open the “Configuration Main Menu”.
- 3 Tap the “Program Setup” icon.
- 4 Tap the “Measurement Method” icon.
- 5 Tap on the “Minimum range” or “Maximum range” row.
- 6 Select the desired measuring range from the drop-down list and confirm your selection with [ENTER].

6.5.1.4 Test object

In the “Test object” row, you can select the time constant Z of the current regulator.



“R” is the setting for purely ohmic resistance in test objects.

The time constants Z0, Z1, Z2, Z3 are selected for test objects with an inductive component. The device cannot recognize inductive test objects on its own. For time-critical applications, an attempt can be made to obtain a faster measurement by selecting a smaller time constant. Start with the largest time constant Z3 and then select the next smaller time constant Z2. If the measured result is the same, you can then continue to use the smaller time constant for the same test objects. Before disconnection, the test object should always be short-circuited.

The measuring range cannot be changed for Z0, Z1, Z2 and Z3 while a measurement is in progress.



This is how it works

- 1 In measurement mode, tap anywhere on the touchscreen. The  icon appears in the bottom right corner.
- 2 Tap  to open the “Configuration Main Menu”.
- 3 Tap the “Program Setup” icon.
- 4 Tap the “Measurement Method” icon.
- 5 Tap the “Test object” row.
- 6 Select the desired setting from the drop-down list and confirm your selection with [ENTER].



DANGER

Before starting any measurement, make sure that the test object is free of any external voltage (e.g. mains voltage, voltage generated by a rotating motor, etc.)

Take care when handling inductive test objects. The physics are such that potentially lethal voltages can occur when the test current is disconnected.

- Dangerous induction voltages can occur when:
 - The connectors are removed from the socket
 - The test current (measuring range) is changed or switched off (STOP)
 - The leads break
 - The connections on the test object are loose
 - The instrument is switched off during the measurement
 - The power fails during the measurement
 - The test current changes for whatever reason
 - A fuse blows
 - An inductive test object must not be connected or disconnected in the START state.
- **Before disconnection, the test object should always be short-circuited.**

6.5.1.5 Type of measurement

In the “Measurement type” row, you can switch between “Single”, “Continuous” and “N measurements”.



Single measurement: “Start” (button, interface, etc.) starts a measurement that stops depending on the defined number of mean values. The classic single-shot measurement.

Continuous measurement: “Start” (button, interface, etc.) starts a measurement that has to be actively stopped with “Stop” (button, interface, etc.)

N measurements: “Start” (button, interface, etc.) starts a measurement that stops depending on the defined number of mean values and the defined number of measurements. Only the n th measured value is output.



This is how it works



- 1 In measurement mode, tap anywhere on the touchscreen. The  icon appears in the bottom right corner.
- 2 Tap  to open the “Configuration Main Menu”.
- 3 Tap the “Program Setup” icon.
- 4 Tap the “Measurement Method” icon.
- 5 Tap in the “Measurement type” row to switch between measurement types.

6.5.1.6 N measurements

In the “N measurements” row, you can define which number measured value is displayed with the “N measurements” measurement type. If another measurement type is selected, this row is grayed out.



This is how it works



- 1 In measurement mode, tap anywhere on the touchscreen. The  icon appears in the bottom right corner.
- 2 Tap  to open the “Configuration Main Menu”.
- 3 Tap the “Program Setup” icon.
- 4 Tap the “Measurement Method” icon.
- 5 Tap the “N measurements” row.
- 6 Use the keypad to enter the desired value for n and confirm with **[OK]**.

6.5.1.7 Mean values

In the “Mean values” row, you can define how many measured values are used to calculate the displayed measured value.



This is how it works

- 1 In measurement mode, tap anywhere on the touchscreen. The  icon appears in the bottom right corner.
- 2 Tap  to open the “Configuration Main Menu”.
- 3 Tap the “Program Setup” icon.
- 4 Tap the “Measurement Method” icon.
- 5 Tap the “Mean values” row.
- 6 Use the keypad to enter the desired number of values and confirm with **[OK]**.

6.5.1.8 Averaging

The method by which averaging is performed is defined in the “Averaging” row.



Renew Means that if an averaging value of 10 is entered, a new value (mean value) only appears on the display after 10 measurements.

Sliding Means that if an averaging value of 10 is entered, after the start or after a measurement error occurs, a new value (mean value) only appears on the display after 10 measurements – as described above.

But with each additional internal measurement, the new measured value is used to calculate a new mean value, which is displayed accordingly.



This is how it works

- 1 In measurement mode, tap anywhere on the touchscreen. The  icon appears in the bottom right corner.
- 2 Tap  to open the “Configuration Main Menu”.
- 3 Tap the “Program Setup” icon.
- 4 Tap the “Measurement Method” icon.
- 5 Tap in the “Averaging” row to switch between “Sliding” and “Renew”.

6.5.1.9 Resolution



You can change the resolution of the display in the “Resolution” row.

20000: Resolution of 20000 (5-digit display)

2000: Resolution of 2000 (4-digit display)



This is how it works

- 1 In measurement mode, tap anywhere on the touchscreen. The  icon appears in the bottom right corner.
- 2 Tap  to open the “Configuration Main Menu”.
- 3 Tap the “Program Setup” icon.
- 4 Tap the “Measurement Method” icon.
- 5 Tap in the “Resolution” row to switch between 20000 and 2000.

6.5.1.10 Limiting



6.5.1.11 Conversion

You can define the conversion level in this row. The device has a very fast A/D converter, with settings for 4 conversion time levels. The conversion times for the individual levels depend on the set measuring range and the selected resolution.

Minimum	Smallest number of conversions
Medium	Second smallest number of conversions
Standard	Second largest number of conversions
Maximum	Largest number of conversions



This is how it works

- 1 In measurement mode, tap anywhere on the touchscreen. The  icon appears in the bottom right corner.
- 2 Tap  to open the “Configuration Main Menu”.
- 3 Tap the “Program Setup” icon.
- 4 Tap the “Measurement Method” icon.
- 5 Tap the “Conversion” row.
- 6 Activate the radio button for the conversion you want to select, and confirm your selection with [ENTER].



6.5.1.12 Measurement sequence

In this row, you can define where zero point compensation occurs in the measurement sequence.

Standard	Zero measurement is carried out alternately before each measurement point.
Comp. once	Zero measurement only takes place once at the start.
No comp.	Measurement without zero measurement.
Ref. comp.	Reference zero measurement for thermoelectric voltage compensation.



This is how it works

- 1 In measurement mode, tap anywhere on the touchscreen. The  icon appears in the bottom right corner.
- 2 Tap  to open the “Configuration Main Menu”.
- 3 Tap the “Program Setup” icon.
- 4 Tap the “Measurement Method” icon.
- 5 Tap the “Measurement sequence” row.
- 6 Activate the radio button for the measurement sequence you want to select, and confirm your selection with [ENTER].

6.5.1.13 Test current



In this row, depending on the set measuring range, you can switch between the high or low test current settings.

Depending on the environment at the test location, strong electromagnetic fields can cause the displayed resistance value to fluctuate. This can be remedied by averaging several measurements or increasing the test current to achieve a higher signal-to-noise ratio. This setting is recommended for larger motors or transformers. With smaller winding materials (smaller cross-sectional area), check the extent to which heating occurs due to the higher test current. The low test current is set by default. The following table applies:

Measuring range	Resolution	Low test current	High test current
20 mΩ	0.001 mΩ	1 A	1 A
200 mΩ	0.01 mΩ	100 mA	1 A
2 Ω	0.0001 Ω	10 mA	100 mA
20 Ω	0.001 Ω	10 mA	100 mA
200 Ω	0.01 Ω	1 mA	10 mA
2 kΩ	0.1 Ω	100 μA	1 mA
20 kΩ	1 Ω	100 μA	100 μA
200 kΩ	10 Ω	10 – 100 μA	10 – 100 μA



This is how it works

- 1 In measurement mode, tap anywhere on the touchscreen. The  icon appears in the bottom right corner.
- 2 Tap  to open the “Configuration Main Menu”.
- 3 Tap the “Program Setup” icon.
- 4 Tap the “Measurement Method” icon.
- 5 Tap the “Test current” row to switch between low and high.

6.5.1.14 If error



This row defines how to proceed in a continuous measurement after a measurement error. If a measurement type other than “continuous” is set, the “If error” row is grayed out.

Continue measuring The measurement error has no effect on the continuous measurement, which is continued.

Stop Continuous measurement is interrupted and stopped by a measurement error. The measurement must then be actively restarted.



This is how it works

- 1 In measurement mode, tap anywhere on the touchscreen. The  icon appears in the bottom right corner.
- 2 Tap  to open the “Configuration Main Menu”.
- 3 Tap the “Program Setup” icon.
- 4 Tap the “Measurement Method” icon.
- 5 Tap the “If error” row to switch between “Continue measuring” and “Stop”.

6.5.1.15 Broken wire test

In this row, you can specify whether and how a broken wire test should be carried out.



Off Broken wire detection is deactivated.

Once Broken wire detection is carried out once with every measurement start.

Always Broken wire detection is carried out before each measurement point.



This is how it works

- 6 In measurement mode, tap anywhere on the touchscreen. The  icon appears in the bottom right corner.
- 7 Tap  to open the “Configuration Main Menu”.
- 8 Tap the “Program Setup” icon.
- 9 Tap the “Measurement Method” icon.
- 10 Tap the “Broken wire test” row.
- 11 Select the desired setting from the drop-down list and confirm your selection with **[ENTER]**.



6.5.2 Comparator

All settings relating to the evaluation of measured values are made in the “Comparator” menu (M51).

The device has a 2-way and 4-way comparator with switching outputs for performing classification and selection.



This is how it works

- 1 To open the “Comparator” menu from measurement mode, tap anywhere on the touchscreen. The  icon appears in the bottom right corner.
- 2 Tap  to open the “Configuration Main Menu”.
- 3 Tap the “Program Setup” icon.
- 4 Tap the “Comparator” icon.

6.5.2.1 Comparator

In this row, you can activate or deactivate the evaluation of the measured value.

When the comparator is activated, the comparator evaluation appears in the measuring mode display as follows, depending on the number of limit values:





Abbildung 19: 2-way comparator display



Abbildung 20: 4-way comparator display



This is how it works

- 1 In measurement mode, tap anywhere on the touchscreen. The  icon appears in the bottom right corner.
- 2 Tap  to open the “Configuration Main Menu”.
- 3 Tap the “Program Setup” icon.
- 4 Tap the “Comparator” icon.
- 5 Tap the “Comparator” row to activate or deactivate evaluation.

6.5.2.2 Limit values

In this row, you can change the setting between 2 and 4 limit values. This determines the number of selection levels.

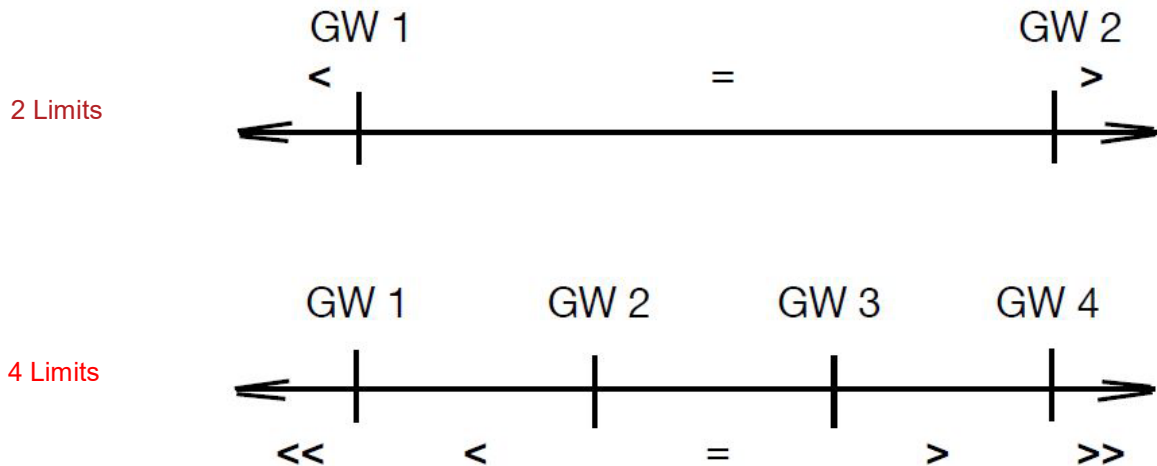



6.5.2.3 If error

In this row, you can set how the device deals with an error in a comparator evaluation.

- None** No action. Measurement error is output. Measurement is continued depending on the setting in “Measurement Method” under “If error”. See section 6.5.1.14.
- >** Any measurement error is evaluated as “too large”. Measurement error is not output.



This is how it works



- 1 In measurement mode, tap anywhere on the touchscreen. The  icon appears in the bottom right corner.
- 2 Tap  to open the “Configuration Main Menu”.
- 3 Tap the “Program Setup” icon.
- 4 Tap the “Comparator” icon.
- 5 Tap the “If error” row to switch between “None” and “>”.

6.5.2.4 Limit values <<, <, >, >>

In these rows, you define the limit values depending on whether 2 or 4 selection levels are set.



This is how it works

- 1 In measurement mode, tap anywhere on the touchscreen. The  icon appears in the bottom right corner.
- 2 Tap  to open the "Configuration Main Menu".
- 3 Tap the "Program Setup" icon.
- 4 Tap the "Comparator" icon.
- 5 Tap the relevant "Limit value" row.
- 6 Use the keypad to enter the required limit value and confirm by tapping the unit.



6.5.3 Data Logger

All settings relating to the internal data logger are made in the "Data Logger" menu (M52).

Each measurement program has storage space for up to 900 measured values.



This is how it works



- 1 To open the "Data Logger" menu from measurement mode, tap anywhere on the touchscreen. The  icon appears in the bottom right corner.
- 2 Tap  to open the "Configuration Main Menu".
- 3 Tap the "Program Setup" icon.
- 4 Tap the "Data Logger" icon.

6.5.3.1 Data Logger

In this row, you can activate or deactivate the internal data logger function.



This is how it works

- 1 In measurement mode, tap anywhere on the touchscreen. The  icon appears in the bottom right corner.
- 2 Tap  to open the “Configuration Main Menu”.
- 3 Tap the “Program Setup” icon.
- 4 Tap the “Data Logger” icon.
- 5 Tap the “Data Logger” row to activate or deactivate the internal data logger function.

6.5.3.2 Filter

In this row, you can make various filter settings to determine which measured values are logged.

OK All OK values are recorded.

NOK All NOK values are recorded.



Nth value Every *n*th measured value is recorded.

Delta t A measured value is recorded after the measurement time Δt .

Delta R A measured value is recorded when the delta between the last and the current measured value \geq the value stored under “Delta R”.



This is how it works



- 1 In measurement mode, tap anywhere on the touchscreen. The  icon appears in the bottom right corner.
- 2 Tap  to open the “Configuration Main Menu”.
- 3 Tap the “Program Setup” icon.
- 4 Tap the “Data Logger” icon.
- 5 Tap the “Data Logger” row.
- 6 Activate the radio button for the filter you want to use, and confirm your selection with **[ENTER]**.

6.5.3.3 Nth value

In this row, you can define the n th measured value that is recorded in the data logger. To do this, “Nth value” must be selected under “Filter”. Otherwise the row is grayed out.



This is how it works



- 1 In measurement mode, tap anywhere on the touchscreen. The  icon appears in the bottom right corner.
- 2 Tap  to open the “Configuration Main Menu”.
- 3 Tap the “Program Setup” icon.
- 4 Tap the “Data Logger” icon.
- 5 Tap the “Nth value” row.
- 6 Use the keypad to enter the desired value and confirm with **[OK]**.

6.5.3.4 Delta t

In this row, you can define a time in the format [hours] [minutes] [seconds], after which a measured value is recorded in the data logger and the time is then restarted. This requires “Delta t” to be selected under “Filter”. Otherwise the row is grayed out.



This is how it works

- 1 In measurement mode, tap anywhere on the touchscreen. The  icon appears in the bottom right corner.
- 2 Tap  to open the “Configuration Main Menu”.
- 3 Tap the “Program Setup” icon.
- 4 Tap the “Data Logger” icon.
- 5 Tap on the corresponding unit field in the “Delta t” row.
- 6 Use the keypad to enter the desired value and confirm with **[OK]**.



6.5.3.5 Delta R

You can define an ohmic delta value in this row. As soon as the delta between the last and the current measured value \geq the Delta R value, this measured value is recorded.

This requires "Delta R" to be selected under "Filter". Otherwise the row is grayed out.



This is how it works



- 1 In measurement mode, tap anywhere on the touchscreen. The  icon appears in the bottom right corner.
- 2 Tap  to open the "Configuration Main Menu".
- 3 Tap the "Program Setup" icon.
- 4 Tap the "Data Logger" icon.
- 5 Tap on the "Delta R" row.
- 6 Use the keypad to enter the required limit value and confirm by tapping the unit.

6.5.3.6 Name

In this row, you can give the data logger recording an appropriate name.



This is how it works

- 1 In measurement mode, tap anywhere on the touchscreen. The  icon appears in the bottom right corner.
- 2 Tap  to open the "Configuration Main Menu".
- 3 Tap the "Program Setup" icon.
- 4 Tap the "Data Logger" icon.
- 5 Tap the "Name" row.
- 6 Enter the desired name using the keypad and confirm with **[OK]**.

6.5.3.7 Free memory

This row shows how much free memory the active measurement program still has. One space corresponds to one measured value.



No settings can be made here.

6.5.3.8 Delete

In this row, you can delete the data logger recording of the active program and clear the memory.



This is how it works



- 1 In measurement mode, tap anywhere on the touchscreen. The  icon appears in the bottom right corner.
- 2 Tap  to open the “Configuration Main Menu”.
- 3 Tap the “Program Setup” icon.
- 4 Tap the “Data Logger” icon.
- 5 Tap the “Delete” row.
- 6 Confirm the deletion by tapping **[ENTER]**.

6.5.4 Max / Min

In the “Max / Min” menu (M53), you can activate or deactivate the recording of the minimum and maximum measured values. For evaluation and resetting, see section 6.2.3. Max / Min.



This is how it works

- 1 In measurement mode, tap anywhere on the touchscreen. The  icon appears in the bottom right corner.
- 2 Tap  to open the “Configuration Main Menu”.
- 3 Tap the “Program Setup” icon.
- 4 Tap the “Max / Min” icon.
- 5 Tap the “Max / Min” row to activate or deactivate the Max / Min recording.

6.5.5 Temperature compensation

The temperature compensation parameters are set in the “Temp. Comp.” menu (M54).

Enabling temperature compensation changes the display value. The value displayed is the resistance that a device made of this material would have if its temperature were e.g. 20 °C. The conversion in the device is carried out as follows:

$$R(t_0) = R(t) \frac{1}{1 + \frac{TK}{1\,000\,000} * (t - t_0)}$$

Where:

t is the real measured temperature

t₀ is the set reference temperature

R(t) is the resistance measured at temperature t

R(t₀) is the resistance at the reference temperature t₀ (usually 20 °C) *

TC is the temperature coefficient in ppm/K

* In Europe, test values are normally specified at a standard temperature of 20 °C. In the USA 23 °C or 25 °C.



This reference temperature can be set to suit individual requirements. See section 6.5.5.4 “Reference temperature”.

6.5.5.1 Compensation

In this row, you can activate or deactivate the temperature compensation.



This is how it works

- 1 In measurement mode, tap anywhere on the touchscreen. The  icon appears in the bottom right corner.
- 2 Tap  to open the “Configuration Main Menu”.
- 3 Tap the “Program Setup” icon.
- 4 Tap the “Temp. Comp” icon.
- 5 Tap the “Compensation” row to activate or deactivate the temperature compensation.



6.5.5.2 Source

In this row, you specify how the real temperature is measured/set. Three sources can be selected.

- Manual** A static, manually entered temperature value is specified to the RESISTOMAT® model 2311 for temperature compensation.
- Pt100** The temperature is measured via a Pt100 temperature sensor (f.e. model 2392-V001) and read in at the corresponding input.
- U Input** The RESISTOMAT® model 2311 has a freely configurable voltage input for temperature measurement. This can be used to connect an infrared pyrometer, for example. For configuration, see section 6.5.7 “U Input”.



This is how it works



- 1 In measurement mode, tap anywhere on the touchscreen. The  icon appears in the bottom right corner.
- 2 Tap  to open the “Configuration Main Menu”.
- 3 Tap the “Program Setup” icon.
- 4 Tap the “Temp. Comp” icon.
- 5 Tap the “Source” row.
- 6 Activate the radio button for the source you want to select, and confirm your selection with [ENTER].

6.5.5.3 Man. Temperature

The manually specified temperature value is entered in this row. To do this, “Manual” must be selected under “Source”. Otherwise the row is grayed out.



This is how it works



- 1 In measurement mode, tap anywhere on the touchscreen. The  icon appears in the bottom right corner.
- 2 Tap  to open the “Configuration Main Menu”.
- 3 Tap the “Program Setup” icon.
- 4 Tap the “Temp. Comp” icon.
- 5 Tap on the “Man. Temperature” row.
- 6 Enter the temperature value using the keypad and confirm with [OK].

6.5.5.4 Reference temperature

The reference temperature, i.e. the standard temperature value for temperature compensation, is defined in this row.



This is how it works



- 1 In measurement mode, tap anywhere on the touchscreen. The  icon appears in the bottom right corner.
- 2 Tap  to open the “Configuration Main Menu”.
- 3 Tap the “Program Setup” icon.
- 4 Tap the “Temp. Comp” icon.
- 5 Tap the “Reference temperature” row.
- 6 Enter the temperature value using the keypad and confirm with **[OK]**.

6.5.5.5 Coefficient

In this row, you can specify the material efficient for temperature compensation. The RESISTOMAT® model 2311 has 10 selectable, material-specific temperature coefficients for the most common materials/alloys. There is also a freely definable, user-specific coefficient. See section 6.5.5.6. “User Coeff.”



This is how it works



- 1 In measurement mode, tap anywhere on the touchscreen. The  icon appears in the bottom right corner.
- 2 Tap  to open the “Configuration Main Menu”.
- 3 Tap the “Program Setup” icon.
- 4 Tap the “Temp. Comp” icon.
- 5 Tap the “Coefficient” row.
- 6 Activate the radio button for the coefficient you want to use, and confirm your selection with **[ENTER]**.

6.5.5.6 User Coeff.

You can define the user-specific coefficient in this row. It is displayed at the bottom of the “Coefficient” list. See section 6.5.5.5 “Coefficient”.



This is how it works

- 1 In measurement mode, tap anywhere on the touchscreen. The  icon appears in the bottom right corner.
- 2 Tap  to open the “Configuration Main Menu”.



- 3 Tap the “Program Setup” icon.
- 4 Tap the “Temp. Comp” icon.
- 5 Tap the “User Coeff.” row.
- 6 Enter the desired value using the keypad and confirm with **[OK]**.

6.5.6 Pt100

The “Pt100” menu (M55) shows the formula on which the calculation of the temperature via the Pt100 sensor is based. You can also define the values of the individual parameters and reset the formula to the default setting via “Reset Default”.



This is how it works

- 1 In measurement mode, tap anywhere on the touchscreen. The  icon appears in the bottom right corner.
- 2 Tap  to open the “Configuration Main Menu”.
- 3 Tap the “Program Setup” icon.
- 4 Tap the “Pt100” icon.
- 5 Tap on the row of the parameter you want to change.
- 6 Enter the desired value using the keypad and confirm with **[OK]**.
- 7 Tap on “Reset Default” to reset the parameters to the default settings.

6.5.7 U Input

The voltage input for temperature measurement is configured in the “U Input” menu (M56).



Note: Permitted voltage range 0 to 10 V

Example:

A pyrometer outputs a voltage of 0 V at 0 °C and a voltage of 10 V at 100 °C.



This is how it works

- 1 In measurement mode, tap anywhere on the touchscreen. The  icon appears in the bottom right corner.
- 2 Tap  to open the “Configuration Main Menu”.
- 3 Tap the “Program Setup” icon.
- 4 Tap the “U Input” icon.
- 5 Tap on the row of the parameter you want to change.
- 6 Enter the desired value using the keypad and confirm with **[OK]**.

6.5.8 Measured Value Display

In the “Meas. Val. Disp.” menu (M57), you can set how the measured value is displayed in measurement mode.



The RESISTOMAT® model 2311 can display the measured value in three different formats:

- | | |
|------------|--|
| Ohm | The measured value is displayed as an ohmic decimal numerical value. |
| d% | The measured value is displayed as a percentage deviation from a predefined reference value. |

Evaluation



This is how it works

- 1 In measurement mode, tap anywhere on the touchscreen. The  icon appears in the bottom right corner.
- 2 Tap  to open the “Configuration Main Menu”.
- 3 Tap the “Program Setup” icon.
- 4 Tap the “Meas. Val. Disp.” icon.
- 5 Tap the “Display” row.
- 6 Activate the radio button for the desired display mode, and confirm your selection with **[ENTER]**.
- 7 If “d%” or “Evaluation” is selected, tap on the “Reference Value” row.
- 8 Enter the desired value using the keypad and confirm with **[OK]**.

6.5.9 Cooling Curve

In the “Cooling Curve” menu (M58), you can set the parameters for the measurement sequence of a cooling curve, and activate the measurement of a cooling curve.

The Cooling Curve measurement mode is allowed in conjunction with all time constants. However, it cannot be used in conjunction with the automatic measuring range.



The following settings are configurable:

- | | |
|---------------------------|---|
| Interval time | This is the time between two measurements. It must always be shorter than the end of measurement. |
| Settling time | With this time, you define the settling phase until measurement recording starts. The settling time starts after tapping remove load. If you tap “Start” but the settling time is still running, measured values are displayed but not logged/recorded until the settling time has elapsed. If you tap “Start” and the settling time has already lapsed, the logging/recording starts when you tap “Start”. |
| End of measurement | This is the time after which measurement ends. It must always be greater than the interval time. |

Note: Upon activation of the cooling curve mode, the RESISTOMAT® model 2311 automatically switches the test object to inductive and activates the time constant Z0. If necessary, this setting can be adjusted to Z1, Z2 or Z3. Upon deactivation of the cooling curve mode, the setting of R for the test object and the time constant setting must be made manually.



This is how it works

- 1 In measurement mode, tap anywhere on the touchscreen. The  icon appears in the bottom right corner.
- 2 Tap  to open the “Configuration Main Menu”.
- 3 Tap the “Program Setup” icon.
- 4 Tap the “Cooling Curve” icon.
- 5 Tap the “Cooling Curve” row to activate or deactivate the mode.
- 6 Tap on the row of the setting you want to change.
- 7 Enter the desired value using the keypad and confirm with **[OK]**.



6.5.10 USB Memory

In the “USB Memory” menu (M59), you can enable/disable data logging on an external USB stick.

Note: If you wish to log the measurement data on the USB stick, you need to individually enable data logging for each measurement program.



This is how it works

- 1 Plug a USB stick into the rear USB port.
- 2 In measurement mode, tap anywhere on the touchscreen. The  icon appears in the bottom right corner.
- 3 Tap  to open the “Configuration Main Menu”.
- 4 Tap the “Program Setup” icon.
- 5 Tap the “USB Memory” icon.
- 6 Activate the checkbox in the “Logging” row to activate logging.
- 7 Tap on the row of the setting you want to change.
- 8 Enter the desired value using the keypad and confirm with **[OK]**.

6.5.11 PLC Test

In the “PLC Test” (M60) menu, you can view the current statuses of the PLC inputs and outputs, or set and reset the PLC outputs. You can also use this function if the device is controlled via the fieldbus option (e.g. PROFINET, EtherNet/IP, EtherCAT). In this case, the corresponding signals are displayed and set/reset.

Note: Please note that when the “IN_AUTO” control input is activated, the “PLC Test” menu (M60) will close automatically and the RESISTOMAT® 2311 will switch to measurement mode.

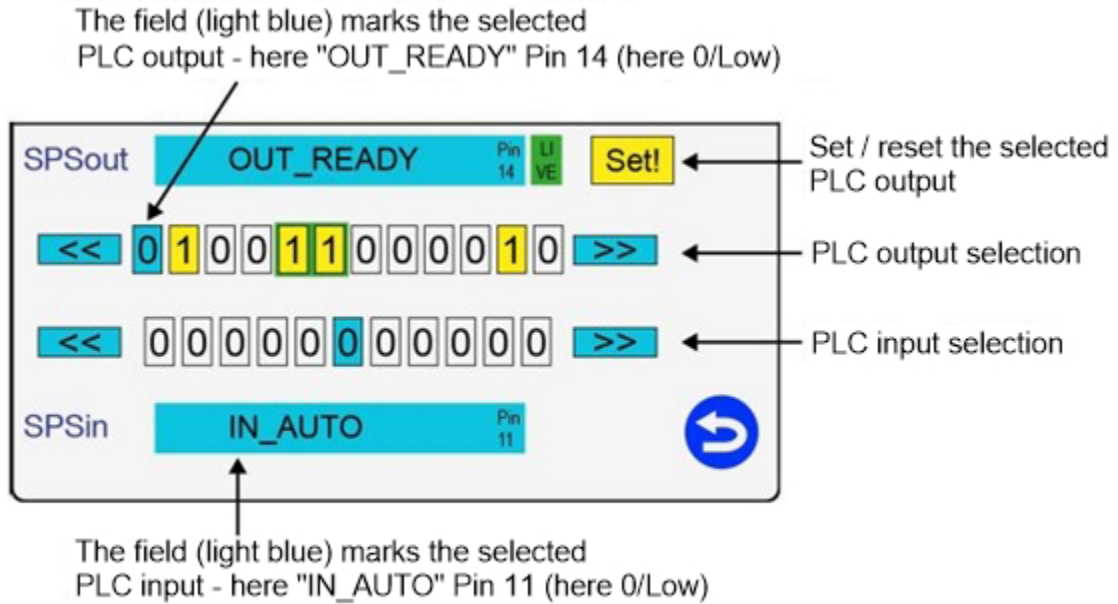

This is how it works

- 1 In measurement mode, tap anywhere on the touchscreen. The icon appears in the bottom right corner.
- 2 Tap to open the “Configuration Main Menu”.
- 3 Tap the “Program Setup” icon.
- 4 Tap the “PLC Test” icon.
- 5 In the upper row, tap [] or [] to select the PLC output you require.
- 6 Tap [**Set!**] or [**Reset!**] to change the state of the PLC output.
- 7 In the lower row, tap [] or [] to select the PLC input you require.

6.6 Copy Programs

In the “Copy Programs” menu (M9), you can copy measurement programs or initialize programs with a set of initial settings.

6.6.1 Copying a measurement program or measurement method



If you want to re-use most of the settings in a measurement program, you can make a copy of the measurement program. You can then tweak these copies to suit the new requirements.

If you want to use just the measurement method settings of a particular measurement program in other measurement programs, the RESISTOMAT® 2311 also lets you copy these settings into other measurement programs.

Note: Once you have overwritten an existing measurement program or its settings, the previous settings in this measurement program are lost.



This is how it works

- 1 In measurement mode, tap anywhere on the touchscreen. The  icon appears in the bottom right corner.
- 2 Tap  to open the “Configuration Main Menu”.
- 3 Tap the “Copy Programs” icon.
- 4 Tap **[Source]** to select the source measurement program for the copy.
- 5 Tap **[From target]** to select the first destination program and then **[To target]** to select the last destination program to which you want to copy the data.

Note: The data is copied to all the measurement programs numbered between **[From target]** and **[To target]** inclusive. If you only want to overwrite one measurement program, select the same program number for **[From target]** and **[To target]**.

- 6 You have a choice of two different copy options: **[Copy measurement settings]** and **[Copy whole setup]**. With **[Copy measurement settings]**, only the settings relating to the measurement method are overwritten. **[Copy whole setup]** overwrites all the settings in the measurement program.
- 7 Tap the copy option you require. A message appears: “Copying measurement settings” or “Copying whole setup”.



6.6.2 Deleting a measurement program

If you want to discard all the settings for one or more measurement programs, you can do this using **[Initialize target program(s)]**. The RESISTOMAT® 2311 then resets the relevant measurement programs to the factory settings. This cannot be undone. The settings of the selected measurement programs are lost.

Note: As soon as you use **[Initialize target program(s)]** to delete an existing measurement program, all the settings in this program are lost.



This is how it works

- 1 In measurement mode, tap anywhere on the touchscreen. The  icon appears in the bottom right corner.
- 2 Tap  to open the “Configuration Main Menu”.
- 3 Tap the “Copy Programs” icon.
- 4 Tap **[From target]** to select the first destination program and then **[To target]** to select the last destination program in which you want to initialize the data.

Note: The data is copied to all the measurement programs numbered between **[From target]** and **[To target]** inclusive. If you only want to overwrite one measurement program, select the same program number for **[From target]** and **[To target]**.

- 5 Tap **[Initialize target program(s)]**. The display shows the message “Target programs will be initialized. All settings will be deleted!”

Note: As soon as you use **[Initialize target program(s)]** to delete an existing measurement program, all the settings in this program are lost.

- 6 Tap **[ENTER]** to reset the destination programs permanently.

7 Display in measurement mode

Note: You can change the assignment of the function keys in the “Basic Setup” menu (M4).

The RESISTOMAT® 2311 starts in measurement mode automatically at power-up. In this operating mode, the RESISTOMAT® 2311 can measure and display the measured value or evaluations.

Note: The PLC control signal “IN_AUTO” is used to prevent the device from switching to configuration mode.

7.1 Full view of measured values

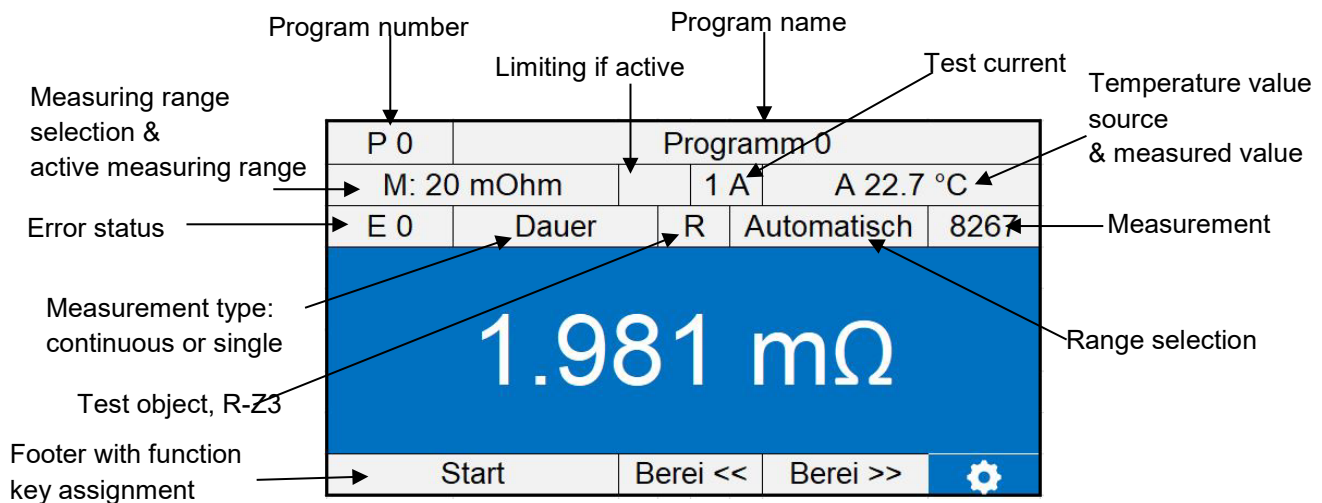

7.2 Error status display

7.2.1 Error status indicator in the error status field

In the event of an error, an error status with the following meaning appears in the display field in status

Hexadecimal display

1	-	Range-Over:	Measuring range overflow. The measured resistance is greater than the set measuring range. (With manual range selection).
2	-	MI-Over:	Test current is too high (with 20 mV operation) or test object or test lead resistance is too high.
4	-	MU-Over:	Instrumentation amplifier for potential taps (U+, U-) overloaded.
8	-	Temp.- Compensation:	Error in temperature compensation, check external sensor.
10	-	Pt100:	Error at Pt100 input. Check Pt100 sensor.
20	-	Cable break:	A broken wire or rather an interruption has been detected.
40	-	Zero comp.:	Error during zero point compensation.
100	-	USB logging:	Error at USB host port (USB stick data logging).
400	-	Port:	No measured value acquired yet, request too early.
800	-	Overheat:	Device temperature too hot for 1 A test current.

Various combinations can appear on the hexadecimal display, e.g.:

A	-	(2+8)	Test current too high and error in temperature compensation
18	-	(10+8)	Pt100 and error in temperature compensation

8 Customer services for your RESISTOMAT® 2311

To complement the RESISTOMAT® 2311 package you have purchased, burster präzisionsmesstechnik gmbh & co. kg offers the following customer services for the RESISTOMAT® family:

- On-site support for preparing the instrument for use
- Initial calibration and recalibration

For customer service inquiries relating to the RESISTOMAT® 2311, please call our customer service department on +49 7224 645-54, or email service@burster.de (in Germany only). In other countries please contact your local representative (see also www.burster.com).

9 Technical data

Please refer to the data sheet for the technical specifications. You can obtain the latest data sheet and additional information on the RESISTOMAT® 2311 on the [product page](#) or simply use the QR code below:



Abbildung 21: QR code for the RESISTOMAT® 2311 product page

9.1 Electromagnetic compatibility

9.1.1 Interference immunity

Interference immunity in compliance with EN 61326-1:2013
Industrial environment

9.1.2 Interference emission

Interference emission in compliance with EN 61326-1:2013

10 Accessories available

Please refer to the data sheet for details of the accessories available. You can obtain the latest data sheet and additional information on the RESISTOMAT® 2311 on the [product page](#) or simply use the QR code below:



Abbildung 22: QR code for the RESISTOMAT® 2311 product page

10.1 Software

The data sheet contains details of the various versions of the DigiControl PC software. You can obtain the latest data sheet and additional information on the RESISTOMAT® 2311 on the [product page](#) or simply use the QR code below:



Abbildung 23: QR code for the RESISTOMAT® 2311 product page

11 Disposal



Battery disposal

In Germany, the end user is legally obliged to return all used batteries, and it is illegal to dispose of batteries in the household waste. This law may also affect you as purchaser of the instrument described here. Please dispose of your used batteries properly and in accordance with national statutory regulations. Either take them to the relevant collection point in your organization or to the collection points provided by your local authority, our company or any battery retail outlet.

Tape over the terminals before storing or disposing of the device to prevent short circuits.

Instrument disposal

If your instrument is no longer usable, please comply with your legal obligations by disposing of the instrument described here in accordance with statutory regulations. You will then be helping to protect the environment!