

Exclusion of warranty liability for operating manuals

All information in the present documentation was prepared and compiled with great care and reproduced subject to effective control measures. No warranty is provided for freedom from errors. We reserve the right to make technical changes. The present information as well as the corresponding technical data can change without notice. Reproduction of any part of this documentation or its processing or revision using electronic systems is prohibited without the manufacturer's prior written approval.

Components, devices and measured value sensors made by burster praezisionsmesstechnik (hereinafter referred to as "product") are the results of targeted development and meticulous research. As of the date of delivery, burster provides a warranty for the proper condition and functioning of these products covering material and production defects for the period specified in the warranty document accompanying the product. However, burster excludes guarantee or warranty obligations as well as any liability beyond that for consequential damages caused by improper use of the product, in particular the implied warranty of success in the market as well as the suitability of the product for a particular purpose. Furthermore, burster assumes no liability for direct, indirect or incidental damages as well as consequential or other damages arising from the provision and use of the present documentation.

The measurement solution.

burster

EU-Konformitätserklärung (nach EN ISO/IEC 17050-1:2010)*EU-Declaration of conformity (in accordance with EN ISO/IEC 17050-1:2010)*

Name des Ausstellers: burster präzisionsmesstechnik gmbh & co kg
Issuer's name:

Anschrift des Ausstellers: Talstr. 1-5
Issuer's address: 76593 Gernsbach, Germany

Gegenstand der Erklärung: RESISTOMAT® zur schnellen Widerstandsmessung in der Automation
Object of the declaration: RESISTOMAT® for Fast Resistance Measurement in Automated Processes

Modellnummer(n) (Typ): 2329
Model number / type:

Diese Erklärung beinhaltet obengenannte Produkte mit allen Optionen
This declaration covers all options of the above product(s)

Das oben beschriebene Produkt ist konform mit den Anforderungen der folgenden Dokumente:*The object of the declaration described above is in conformity with the requirements of the following documents:*

Dokument-Nr. <i>Documents No.</i>	Titel <i>Title</i>	Ausgabe <i>Edition</i>
2011/65/EU	Richtlinie zur Beschränkung der Verwendung bestimmter gefährlicher Stoffe in Elektro- und Elektronikgeräten <i>Directive on the restriction of the use of certain hazardous substances in electrical and electronic equipment</i>	2011
2014/35/EU	Richtlinie zur Harmonisierung der Rechtsvorschriften der Mitgliedsstaaten über die Bereitstellung elektrischer Betriebsmittel zur Verwendung innerhalb bestimmter Spannungsgrenzen auf dem Markt <i>Directive on the harmonization of the laws of the Member States relating to the making available on the market of electrical equipment designed for use within certain voltage limits</i>	2014
2014/30/EU	Richtlinie zur Harmonisierung der Rechtsvorschriften der Mitgliedsstaaten über die Elektromagnetische Verträglichkeit <i>Directive on the harmonization of the laws of the Member States relating to electromagnetic compatibility</i>	2014
EN 61010-1	Sicherheitsbestimmungen für elektrische Mess-, Steuer-, Regel- und Laborgeräte – Teil 1: Allgemeine Anforderungen <i>Safety requirements for electrical equipment for measurement, control and laboratory use – Part 1: General requirements</i>	2010 + Cor.:2011
EN 61326-1	Elektrische Mess-, Steuer-, Regel- und Laborgeräte – EMV-Anforderungen – Teil 1: Allgemeine Anforderungen <i>Electrical equipment for measurement, control and laboratory use – EMC requirements – Part 1: General requirements</i>	2013
EN 55011	Industrielle, wissenschaftliche und medizinische Geräte – Funkstörungen – Grenzwerte und Messverfahren <i>Industrial, scientific and medical equipment – Radio-frequency disturbance characteristics – Limits and methods of measurement</i>	2009

Gernsbach 20.04.2016 i.V. Christian Karius
 Ort / place Datum / date Quality Manager

Dieses Dokument ist entsprechend EN ISO/IEC 17050-1:2010 Abs. 6.1g ohne Unterschrift gültig
 According EN ISO/IEC 17050 this document is valid without a signature.

burster präzisionsmesstechnik gmbh & co kg · Talstr. 1-5 DE-76593 Gernsbach (P.O.Box 1432 DE-76587 Gernsbach) · Tel. +49-7224-6450 · Fax 645-88
www.burster.com · info@burster.com · burster is ISO 9001:2008 certified

Geschäftsführer/Managing Director: Matthias Burster · Handelsregister/Trade Register: Gernsbach · Registergericht/Register Court: Mannheim HRA 530170
 Kompl./Gen. Partn.: burster präzisionsmesstechnik Verwaltungs-GmbH · Handelsregister/Trade Register: Gernsbach · Registergericht/Register Court: Mannheim HRB 530130
 UST-Identnr./VAT No. DE 144 005 098 · Steuernr./Tax Ident No. 39454/10503
 Commerzbank AG Rastatt Kto./Acc. 06 307 073 00 BLZ/Bank code 662 800 53 · Volksbank Baden-Baden* Rastatt eG Kto./Acc. 302 082 00 BLZ/Bank code 662 900 00

Contents

1.	Safety instructions.....	7
1.1	Symbols in this manual.....	7
1.1.1	Signal words	7
1.1.2	Pictograms.....	7
2.	General information	8
2.1	Safety	8
2.2	Applications	8
2.3	Description	9
2.4	Personnel	9
3.	Preparation for Operation	10
3.1	Unpacking the device	10
3.2	Commissioning the device	10
3.3	Supply voltage	10
3.4	Mains fuse.....	11
3.5	Power supply and connection of signal lines.....	11
3.6	Operational test.....	12
3.7	Calibration	12
3.8	Storage	12
4.	Control Elements and Connections	13
4.1	Front panel.....	13
4.1.1	Description of the individual keys.....	14
4.1.2	Description of the terminals.....	15
4.1.3	Block diagram.....	18
5.	Manual Operation	19
5.1	General instructions.....	19
5.1.1	Meaning of the individual display segments.....	19
5.1.2	Overview of controls	20
5.1.3	Measurement errors.....	21
5.1.4	Measurement rate	22
5.2	Identification menu	25
5.2.1	Selecting a language	26
5.2.2	Setting date and time	26
5.3	Main menu	27
5.3.1	Measurement stopped.....	27
5.3.2	Measurement started.....	28
5.3.3	Code input menu	29
5.3.3.1	Access menu.....	29
5.3.3.2	Test PLC inputs and outputs	31

5.4. Function keys while a measurement is stopped.....	33
5.4.1 Datalogger evaluation menu.....	33
5.4.1.1 Display of the individual measurement values	33
5.4.1.2 Stochastic datalogger evaluation menu	34
5.4.2 Comparator evaluation menu	35
5.4.3 Max/Min evaluation menu	36
5.4.4 Parameter selection menu.....	36
5.4.4.1 Measurement parameter menu	37
5.4.4.2 Datalogger setting menu	43
5.4.4.3 Comparator setting menu	46
5.4.4.4 Temperature compensation menu.....	48
5.4.4.5 Display menu.....	50
5.4.4.6 Interface menu.....	51
5.4.4.7 Device setting menu.....	54
5.4.4.8 Printer menu	56
5.4.4.9 Status selection menu	58
5.4.4.10 Additional PLC input/output bits	59
5.4.4.11 Scaling menu.....	60
5.4.4.12 Setting the contrast	63
5.4.4.13 Calibration menu	63
5.4.4.14 Change codes menu	66
6. Remote Control of Device	67
6.1 General Information	67
6.1.1 Terminal assignment of the RS232 interface	67
6.1.2 Control via the RS232 interface.....	67
6.1.3 Terminal assignment of the optional IEEE488 interface.....	69
6.1.4 Control via the optional IEEE488 interface of the RESISTOMAT® model 2329	69
6.1.5 Terminal assignment of the PLC interface.....	71
6.1.6 Control via the PLC interface.....	72
6.2 RESISTOMAT® command language	76
6.2.1 Introduction.....	76
6.2.2 Befehlskopf.....	76
6.2.3 Command tree	77
6.2.4 Query form	77
6.2.5 Navigating the command tree	77
6.2.6 Parameter	78
6.2.7 End-of-command character	78
6.2.8 Special features of the RESISTOMAT® model 2329	78
6.2.9 Effects of the "FETCh?" command while a continuous measurement is in progress ...	78
6.2.10 Status messages	79
6.2.11 Operation Status Register	80
6.2.12 Questionable Status Register	80

6.2.13	Standard Event Register	80
6.2.14	Status Byte	81
6.3	SCPI commands	82
6.3.1	STATus Subsystem	82
6.3.2	SYSTem Subsystem	85
6.3.3	DISPlay Subsystem	87
6.3.4	SOURce Subsystem	90
6.3.5	TRIGger Subsystem.....	90
6.3.6	Measurement Instructions	91
6.3.7	MEMory Subsystem	91
6.3.8	REGister Subsystem.....	92
6.3.9	HCOPy Subsystem.....	93
6.3.10	CALCulate Subsystem.....	97
6.3.11	SENSE Subsystem.....	103
6.3.12	SCALe Subsystem.....	110
6.3.13	ACCess Subsystem.....	112
6.3.14	DATallogger Subsystem.....	118
6.3.15	IEEE488.2 commands	126
6.4	Status Register	130
6.4.1	Standard Event Status Register.....	130
6.4.2	Questionable Status Register	130
6.4.3	Operation Status Register	130
6.5	Sample programs	131
6.5.1	Sample programs for the RS232 interface	131
6.5.2	Sample programs for the IEEE488 interface.....	134
6.6	Error status display	140
6.6.1	Error status display in the error status field	140
6.6.2	Error status display in the temperature display field.....	141
6.6.3	Calibration Error.....	141
7.	Maintenance and Customer Service	142
7.1	Maintenance	142
7.2	Customer Service	142
7.3	Manufacturer's guarantee	142
7.4	Clening the device	142
8.	Technical Data	143
9.	Disposal	145
10.	Appendix - Control Example	146



1. Safety instructions

On the device RESISTOMAT® model 2329 and in this manual the following symbols warn about risks:

1.1. Symbols in this manual

1.1.1. Signal words



The following signal words are used in the operating manual according to the specified hazard classification.

	DANGER
DANGER indicates a hazard with a high level of risk which, if not avoided, will result in death or serious injury.	
	WARNING
WARNING indicates a hazard with a medium level of risk which, if not avoided, could result in death or serious injury.	
	CAUTION
CAUTION indicates a hazard with a low level or risk which, if not avoided, could result in minor or moderate injury.	
NOTICE	
Property damage to the equipment or the surroundings will result if the hazard is not avoided.	

Hinweis: It is important to heed these safety notices in order to ensure correct handling of the RESISTOMAT® model 2329.

WICHTIG: Follow the information given in the operating manual.



1.1.2. Pictograms

	Danger of electric shock!
	Observe the safety notices for protecting the instrument.

2. General Information



2.1 Safety

	 DANGER
	<p>Special caution is required in the case of inductive test devices!</p> <p>If</p> <ul style="list-style-type: none"> - the plugs are pulled out of their sockets, - the measurement current is switched over, - the cables tear, - the terminals on the test device are loose, - the unit is switched off during measurement, - the power is interrupted during measurement, - the measurement current changes for any other reason: <p>then</p> <p style="padding-left: 20px;">extremely dangerous inductive voltages can be generated under these physical conditions!</p>

A danger arises when ever the current flow through the test object is interrupted. In this case, an extremely hazardous voltage is induced in the test object. Therefore, particular caution is required when the test object is being disconnected from the RESISTOMAT® model 2329 or if the contacts slip off or drop while energy is still stored in the test object. As the RESISTOMAT® model 2329 does not indicate the level of this energy, the test object must be short-circuited prior to disconnection in order for it to discharge fully.

For safety reasons, inductive test objects must not be unplugged from the device. If a partially or fully grounded inductive test unit is unplugged from the device, a voltage flashover might occur in the plug, thus exposing the operator to the flow of current in the electrical circuit of the test object. This is extremely hazardous !

Great care must be exercised if the RESISTOMAT® model 2329 exhibits abnormal behaviour. For example: No response to actuation of controls;
 No supply of measurement results;
 Unusual displays.

In such cases, always short-circuit the inductive test object and then disconnect it.

2.2 Applications

Important: Read then operating manual carefully before using the equipment, and keep for future reference.

The RESISTOMAT® model 2329 is particularly suitable for measurements of low impedances in automation technology, and is capable of performing up to 50 measurements per second without any problem. This RESISTOMAT® model 2329 complies with the latest CE guidelines and is designed for use in the laboratory as well as heavy-duty industrial applications.

Classification and selection can be performed using a 2-fold and 4-fold comparator with switching outputs; this feature is particularly useful for conducting serial tests.

The measurement of contact resistances (dry-circuit measurement) constitutes a special application, as the load voltage in this case is limited to 20 mV (DIN 41640, Part 4 and IEC 132-1) to prevent 'wetting'.

The RS232 (standard) and IEEE488 (optional) computer interfaces allow fully automatic testing stations to be set up. The PLC interface of the device allows it to be easily integrated into production control systems.

Typical applications include measurements of the resistance and conductivity of:

- Melting fuses
- Airbag triggers
- Magnetic coils for automobiles and electrical fittings
- Plug-contacts and switches
- Commutator welded-joints
- Meter samples in cable manufacture
- Conducting tracks

2.3 Description

The RESISTOMAT® model 2329 operates on the basis of proven 4-wire technology, whereby line and contact resistances are eliminated. The measurement lines are monitored with an integrated cable-breakage sensor.

Needless to say, temperature compensation has been included for different test materials, such as copper, brass, tungsten etc. Temperatures are measured using a Pt100 sensor, infrared sensor (pyrometer) or any temperature transmitter equipped with an analog output.

For the measurement of low inductances, the measurement inputs are equipped with a special protective mechanism which prevents voltage peaks from damaging the RESISTOMAT® model 2329 when it is disconnected from the test object.

If test measurements involving several different parameters need to be performed in an automatic measuring system, up to 32 device settings such as the measurement range, limiting values, temperature coefficient etc. can be stored for this purpose. These settings are called up by means of a 5-bit pattern. Naturally, all device settings can also be performed via the RS232 or optional IEEE488 interface.

For serial measurements and production monitoring, the integrated datalogger can be used to store up to 20.000 measured values, which can be divided into 32 individual blocks. A digital filter is used to preselect the measured values to be stored. The stochastic datalogger evaluation menu displays the maximum, minimum and average values, as well as the standard deviation.

2.4 Personnel

Personnel must be familiar with the relevant regulations. They must follow these regulations. Only trained personnel who are familiar with the applicable safety regulations are permitted to operate the RESISTOMAT® model 2329.

3. Preparation for Operation

3.1 Unpacking the device

	 DANGER
	<p>Risk of electric shock.</p> <p>Never switch on the instrument if it shows signs of damage in transit. Only ever use the instrument under the conditions specified in this operating manual.</p>

The RESISTOMAT® model 2329 weighs 5.2 kg and is enclosed in a suitable, shockproof packaging. Unpack the device carefully and ensure that the scope of delivery is complete.

Standard scope of delivery includes:



- 1 RESISTOMAT® model 2329
- 1 Connecting cable
- 1 Copy of this manual
- 1 Demo CD.

Check the device thoroughly for any signs of damage. If any damage seems to have occurred during transport, please notify the supplier within 72 hours. The packaging should be retained so that it can be examined by the manufacturer and/or supplier. The RESISTOMAT® model 2329 must only be transported in its original or an equivalent packaging.

3.2 Commissioning the device

Ensure that the mains voltage selector is set to the correct supply voltage. Using the accompanying cable, connect the device to a standard, grounded socket.

Important: On no account should the device be switched on if it seems to have been damaged during transport. Dispersion from the mains network can give rise to hazardous voltages on the housing and at the measurement input.

	 DANGER
	<p>Risk of electric shock.</p> <p>Never switch on the instrument if it shows signs of damage in transit. Only ever use the instrument under the conditions specified in this operating manual.</p>

3.3 Supply voltage

The supply voltage has been set to 230 V~ at the factory; it can be change using the rotary selector switch.

Supply voltage:	230 V~ ± 10 %
Frequency range:	47 Hz ... 63 Hz
Power consumption:	25 VA
Fuse rating:	0.125 AT

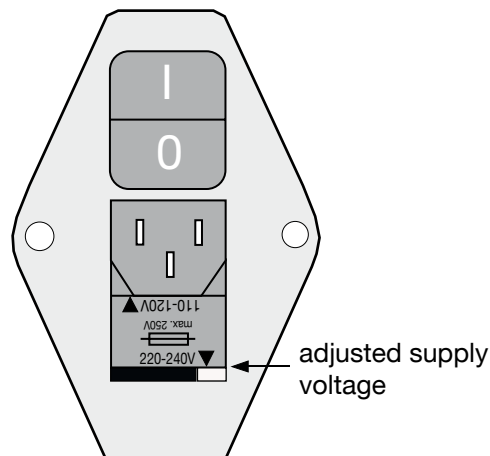

Mains voltage selector switch with fuse catch

The RESISTOMAT® model 2329 is preset to a supply voltage of 230 V. By removing the fuse catch and turning the selector switch 180°, the RESISTOMAT® model 2329 can be set to a supply voltage of 115 V. **Observe the fuse rating!**

3.4 Mains fuse

DANGER

Risk of electric shock.

Before replacing the fuse, ensure that the RESISTOMAT® model 2329 has been properly disconnected from the mains (remove the connection cable from grounded socket).

The mains fuse is located below the mains connection socket on the rear panel of the RESISTOMAT® model 2329.

Only use original 5 x 20 mm, 0.125 AT fuses for 230 V~ and 0.2 AT fuses for 115 V~.

3.5 Power supply and connection of signal lines

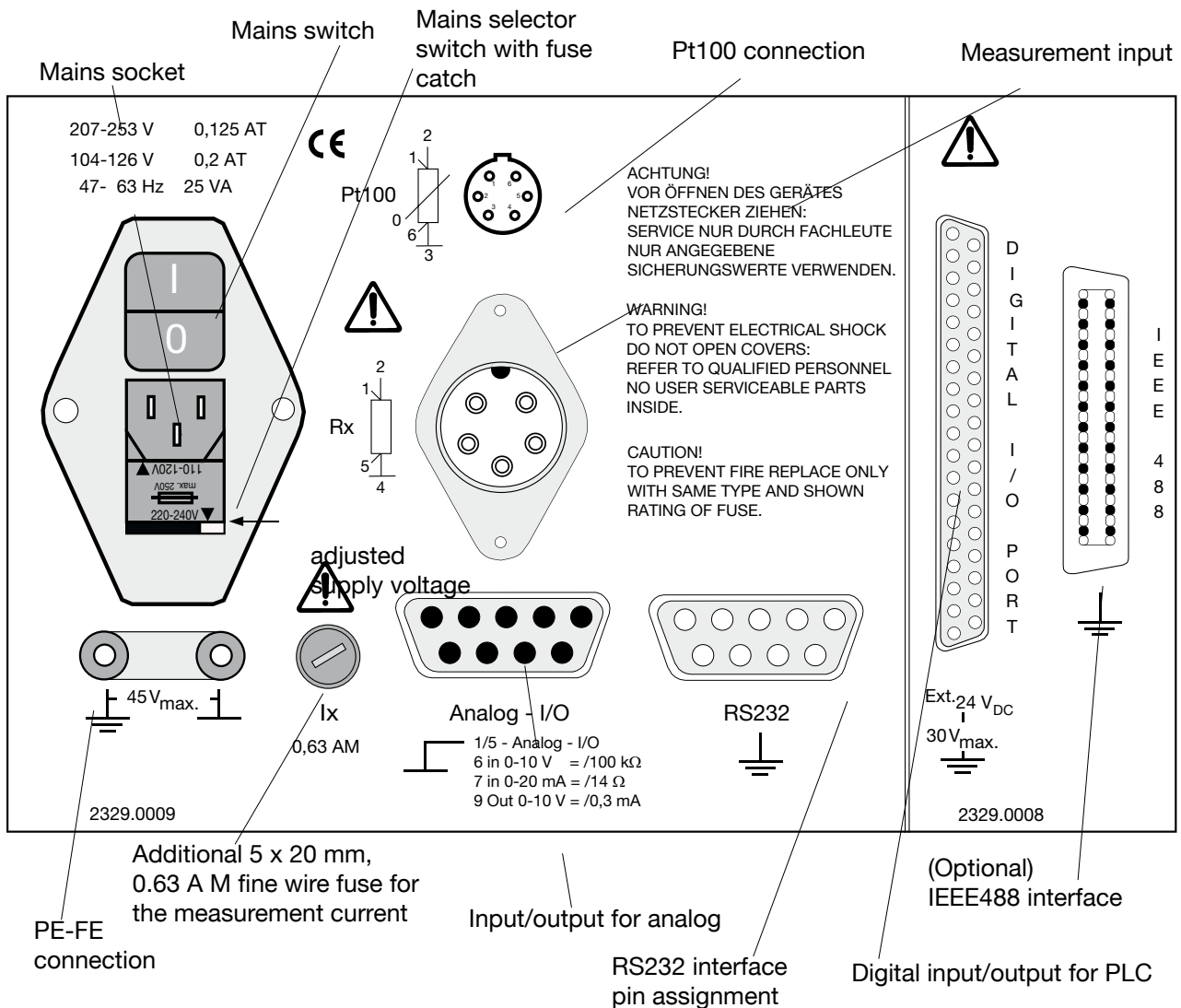

- For reasons of electromagnetic compatibility, the mains socket of the RESISTOMAT® model 2329 must only be connected to the 230 V~ (115 V~) mains network using the ferrite-coated, shielded cable included in the scope of delivery.
- The optional IEEE488 bus-connection plug is standardized. To observe applicable interference protection guidelines, only a shielded interface cable and shielded plugs must be used.
- The standard RS232 interface must only be connected using a shielded, twisted cable and shielded plugs.

- The Pt100 terminal must only be connected to a Pt100 sensor by means of a shielded cable. The cable shield must not be located on the plug housing in the event of any uncertainty concerning the sensor ground, as this might result in measurement errors caused by double-ground compensation currents.
- The Rx measurement input must only be connected using a cable with individually shielded wires. The maximum permissible capacitance here is 10 nF. The observation of this limit is particularly important in the case of high-impedance test objects.

3.6 Operational test

After the RESISTOMAT® model 2329 is turned on, the following text is displayed for about 5 seconds:

RESISTOMAT TYP 2329			
SN:	123456		
VERSION:	V201202		
CAL:	C0001		
DATE:	16.12.13		
TIME:	13:25:26		
LANG	TIME		MAIN

Exception: This text does not appear if a quick start has been activated in access menu (see chapter 5.3.3.1)

3.7 Calibration

The RESISTOMAT® model 2329 is calibrated before delivery.

The measurement instruments used for this purpose comply with DIN ISO 9000ff standards.

The RESISTOMAT® model 2329 should be re-calibrated once every year or so.

Re-calibration is performed via the RS232 interface; this task should only be carried out by the manufacturer.

Basic balancing of the individual measurement ranges is described in chapter 5.4.4.13 titled "Balancing".

3.8 Storage

Permissible storage temperatures lie between -10°C and 60 °C.

If the RESISTOMAT® model 2329 has been exposed to moisture during storage, ensure that it is completely dry on the inside and outside before commissioning it.

No other measures are required for commissioning after storage.

4. Control Elements and Connections

4.1 Front panel

A touch-sensitive membrane keypad is used here.

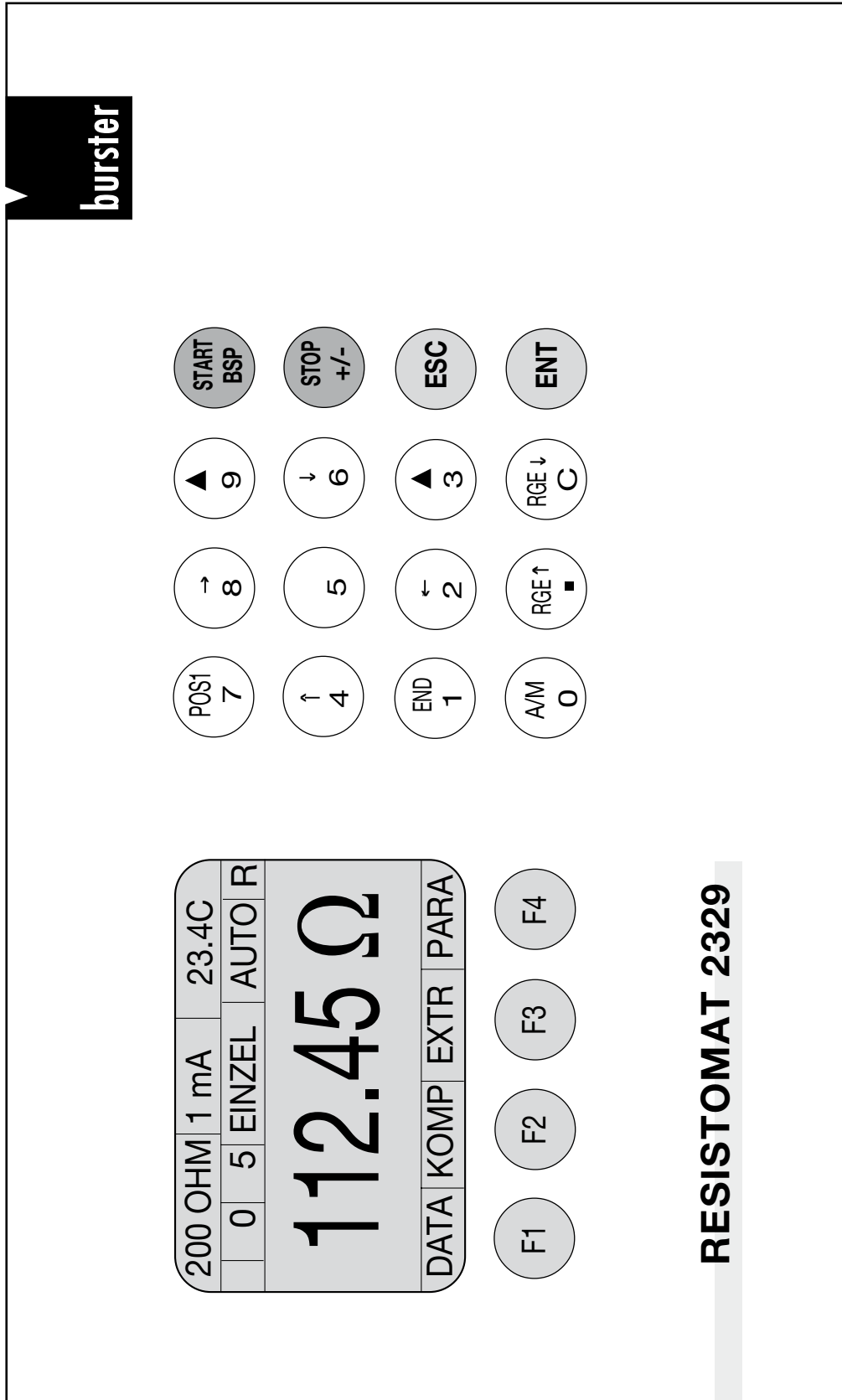

As shown in the illustration, some keys have a dual function.

4.1.1 Description of the individual keys

- [BSP] : This key (Backspace) is used to delete the character entered last.
- [START] : This key commences a measurement.
- [+/-] : This key is used to enter the sign of a numerical value.
- [STOP] : This key is used to stop a measurement.
- [ESC] : This key is used to cancel a current entry, and exit the input mode
- [ENT] : This key is used to acknowledge an entry or a selection.
- [9] : Number 9.
- [↑] : The Page-Up key is used to select the previous page of a multi-page menu.
- [6] : Number 6.
- [→] : The right cursor key is used to select parameter values.
- [3] : Number 3.
- [↓] : The Page-Down key is used to select the next page in a multi-page menu.
- [C] and : This key is used to fully delete the current entry repeat the input procedure from the beginning, without exiting the input mode.
- [RGE ↵] : When manual range selection is active, this key is used to select the next lower measuring range in the main menu.
- [8] : Number 8.
- [↑] : The cursor-up key is used to select a parameter in a menu.
- [5] : Number 5.
- [2] : Number 2.
- [↓] : The cursor-down key is used to select a parameter in a menu.
- [.] : Entry of a decimal point.
- [RGE ↑] : When manual range selection is active, this key is used to select the next higher measuring range in the main menu.
- [7] : Number 7.
- [POS1] : This key effects a jump to the first parameter in any menu window.
- [4] : Number 4.
- [←] : The left cursor key is used to select parameter values.
- [1] : Number 1.
- [END] : This key effects a jump to the last parameter in a menu window.
- [0] : Number 0.
- [A/M] : When a measurement is not in progress, this key is used to changeover between automatic and manual range selection in the main menu.
- [F1], [F2],[F3], [F4] : These programmable keys have different functions depending on the menu in which they are used. Their designations are displayed in the bottom line of each menu.

4.1.2 Description of the terminals

Measurement input

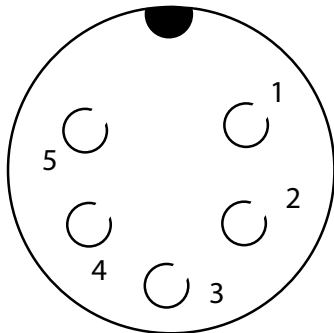

View of the socket

- 1 + U
- 2 + I
- 3 Analog GND
- 4 - I
- 5 - U

Plug housing : Potential PE
Counter-plug : burster type 9900-V172

Note: The current path is protection with a 5 x 20 [mm] 0.63 MT fuse (located on the rear panel of the device).

Pt100 input

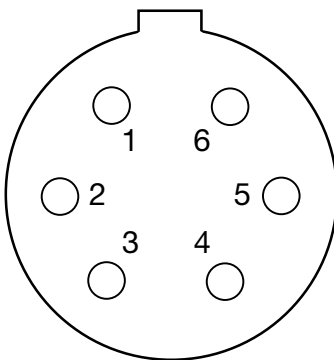

View of the socket

- 1 + U
- 2 + I
- 3 - I
- 4 Functional ground
- 5 Functional ground
- 6 - U

Plug housing : Potential PE
Counter-plug : burster type 4291-0

Two-wire technique can be used if the corresponding sensor terminals are bridged.

Note: NEVER apply the cable shield to the plug housing if there is any uncertainty

Analog I/O

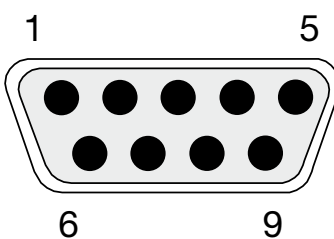

9 pole Sub MinD plug
View of the plug

- 1 Analog GND
- 2 NC
- 3 NC
- 4 NC
- 5 Analog GND
- 6 0-10 V input for temperature measurement ($R_E > 100 \text{ k}\Omega$)
- 7 4/0-20 mA input for temperature measurement ($R_E < 20 \text{ }\Omega$)
- 8 NC
- 9 0-10 V analog output of the measurement signal ($I_{\max} \leq 0.2 \text{ mA}$)

Plug housing : Potential PE
Counter-plug : Type 9900-V609

Note: The mA input (pin 7) is protected internally by a 5 x 20 [mm] 0.25 AT fuse.

RS232 interface

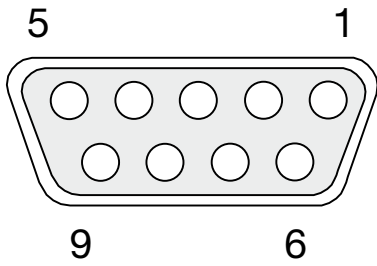

9 pole Sub MiniD socket
View of socket

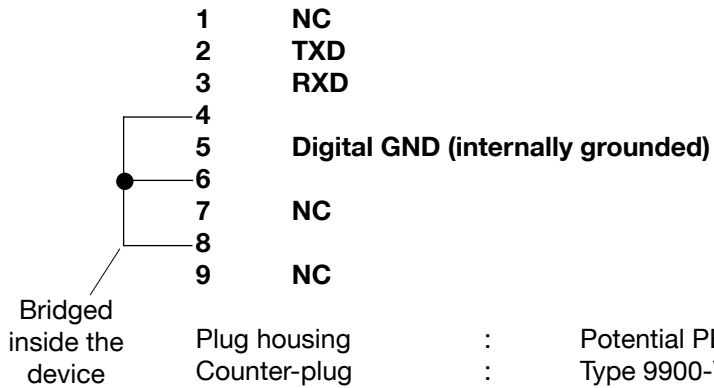

Plug housing	:	Potential PE
Counter-plug	:	Type 9900-V209
Matching data cable	:	Type 9305-K001

IEEE488 interface

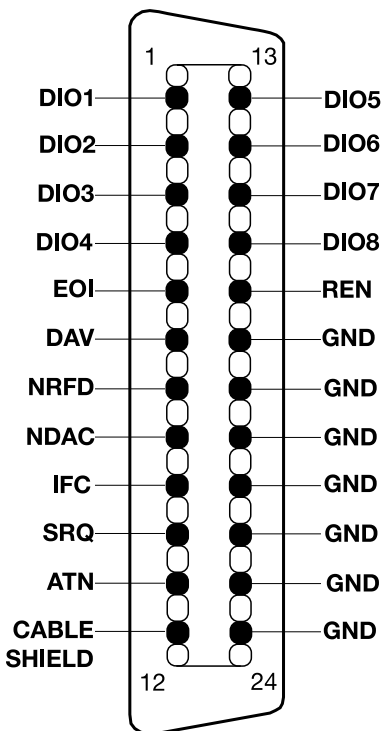

The 24-pole IEEE488 bus plug-connector is standardized and has the displayed pin assignment.

To comply with applicable interference protection guidelines (VDE 0871B), all interface cables and plugs must be shielded at both ends.

Plug housing	:	Potential PE
Matching data cable	:	Type 5230-001

GND is internally grounded.

PE-FE connection



Device socket

In the case of ungrounded (or unearthed) test objects, PE-FE must be connected to the short-circuit bridge.

In the case of grounded (or earthed) test objects, the short-circuit bridge must be removed, otherwise double-ground compensation currents might arise and lead to measurement errors.

Black:	FE <u>F</u> unctional <u>e</u> arth
Yellow/green:	PE <u>P</u> rotective <u>e</u> arth

Digital I/O

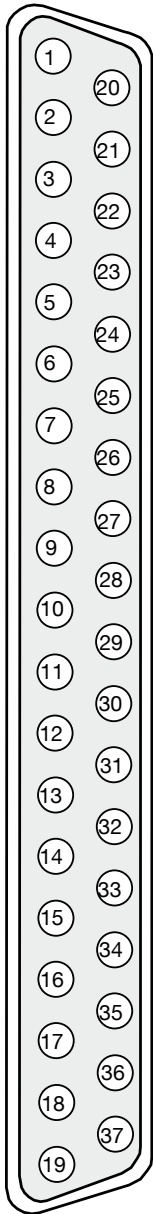

Pin	4 LV*	2 LV*	
1	<<	<	} Potential-free relay output for evaluation $P_{max} = 30\text{ W}$ $U_{max} = 48\text{ V}$ $I_{max} = 1\text{ A}$
2	<		
3	=	=	
4	>		
5	>>	>	
6	ROOT RELAY		} PLC output for evaluation
7	MEASUREMENT IN PROGRESS		
8	MEASUREMENT COMPLETE		
9	MEASUREMENT ERROR		} BINARY SELECTION OF THE DEVICE SETTING
10	<<	<	
11	<		
12	=	=	
13	>		
14	>>	>	
15	OUTPUT 1		} START/STOP MEASUREMENT
16	OUTPUT 2		
17	OUTPUT 3		
18	+ EXT. SUPPLY		} START/STOP COMPARATOR
19	+ EXT. SUPPLY		
20	- EXT. SUPPLY		
21	START/STOP MEASUREMENT		} START/STOP DATALOGGER
22	START/STOP COMPARATOR		
23	START/STOP DATALOGGER		
24	START/STOP MAX/MIN		
25	START/STOP PRINTER		
26	SAVE device setting pins 28 -32		} START/STOP MAX/MIN
27	INPUT 1		
28	Bin 0		
29	Bin 1		
30	Bin 2		
31	Bin 3		} START/STOP PRINTER
32	Bin 4		
33	INPUT 2		
34	INPUT 3		
35	INPUT 4		
36	FOOT SWITCH START/STOP		} FOOT SWITCH START/STOP
37	FOOT SWITCH START/STOP		

*LV = Limit value

37 pole Sub MinD
View of the socket

further description on page 71-75

Plug housing: Potential PE
Counter-plug: Type 9900-V165

4.1.3 Block diagram

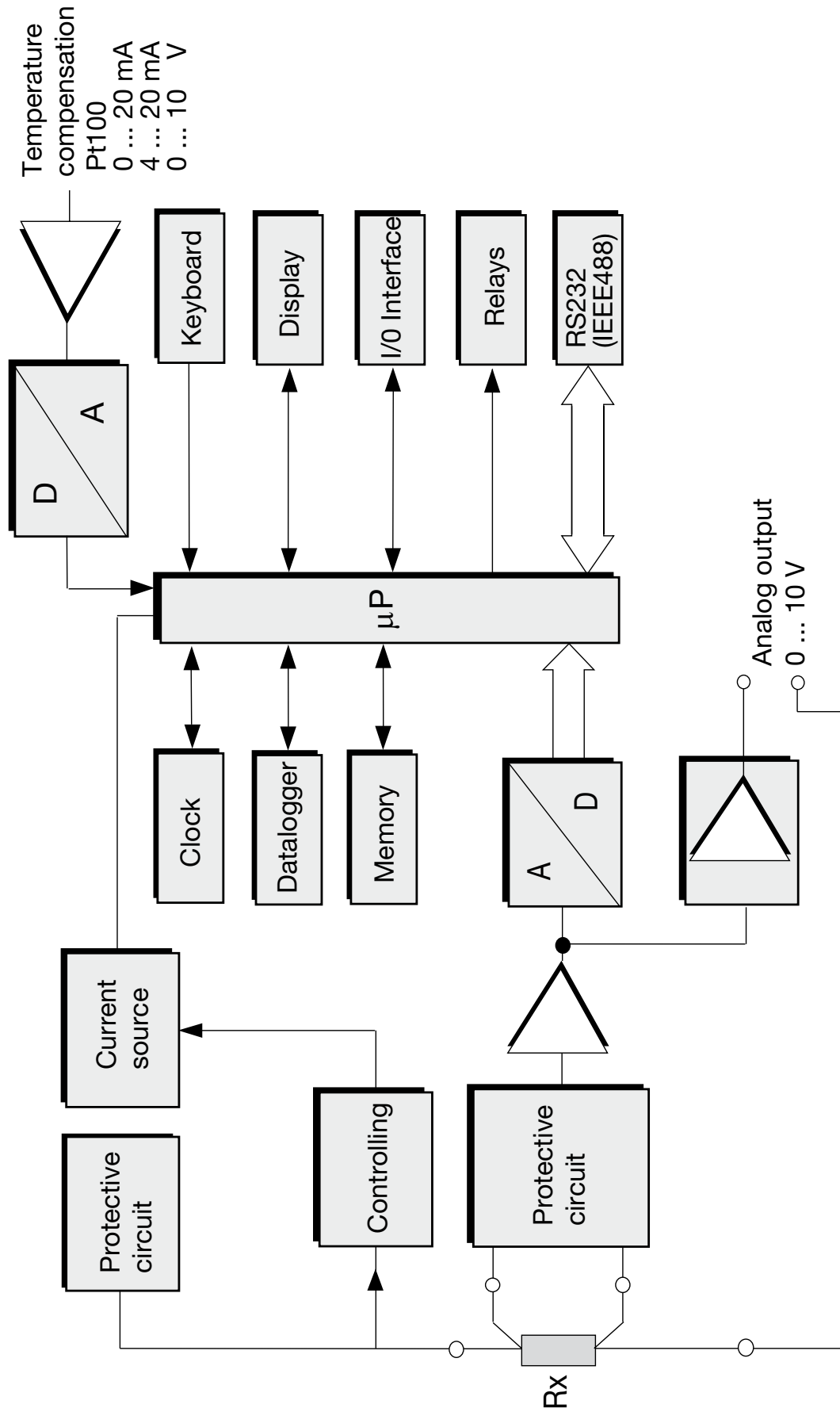

5. Manual Operation

5.1 General instructions

5.1.1 Meaning of the individual display segments

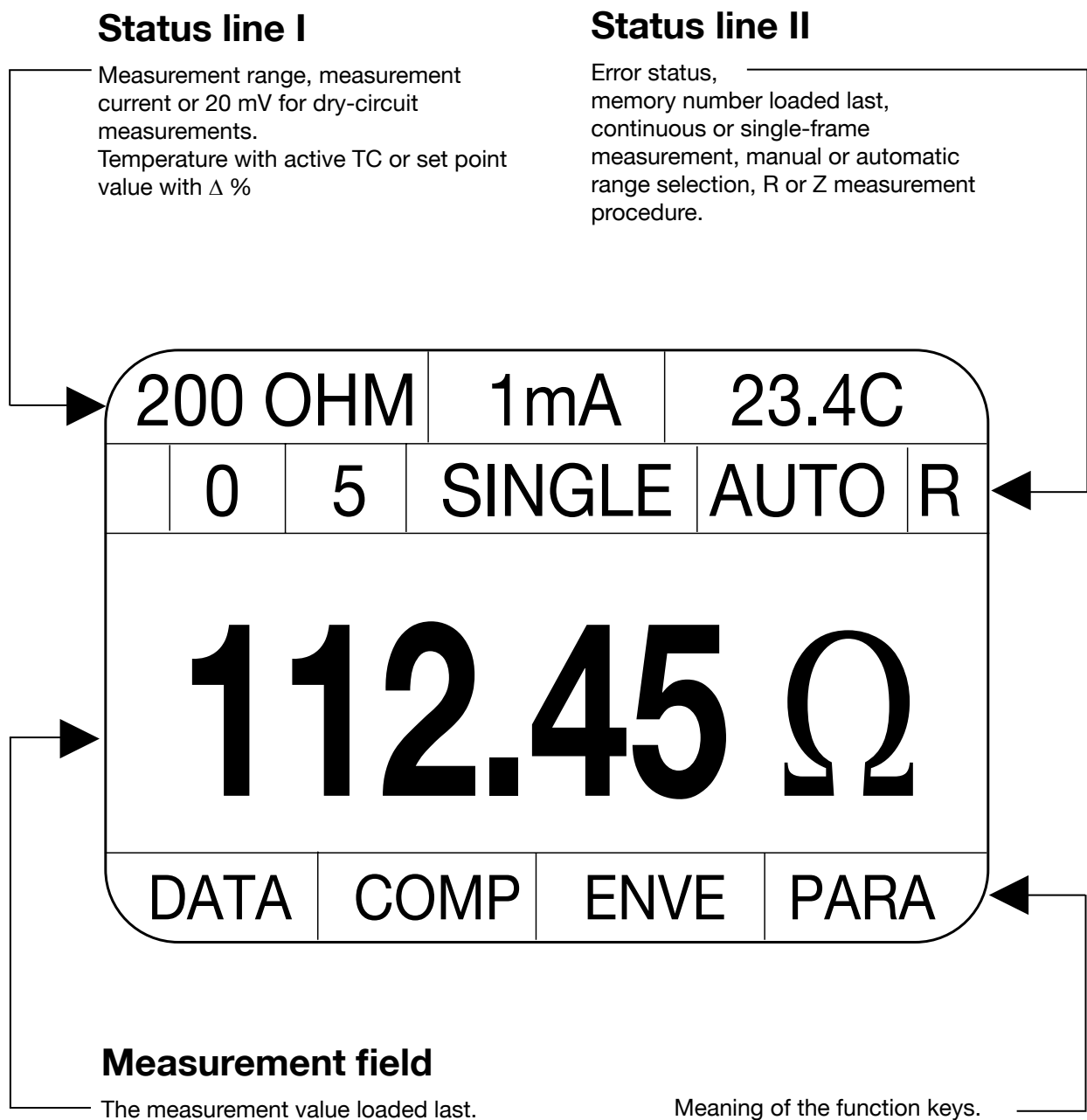

5.1.2 Overview of controls

Control example for device settings see chapter 10 appendix page 146

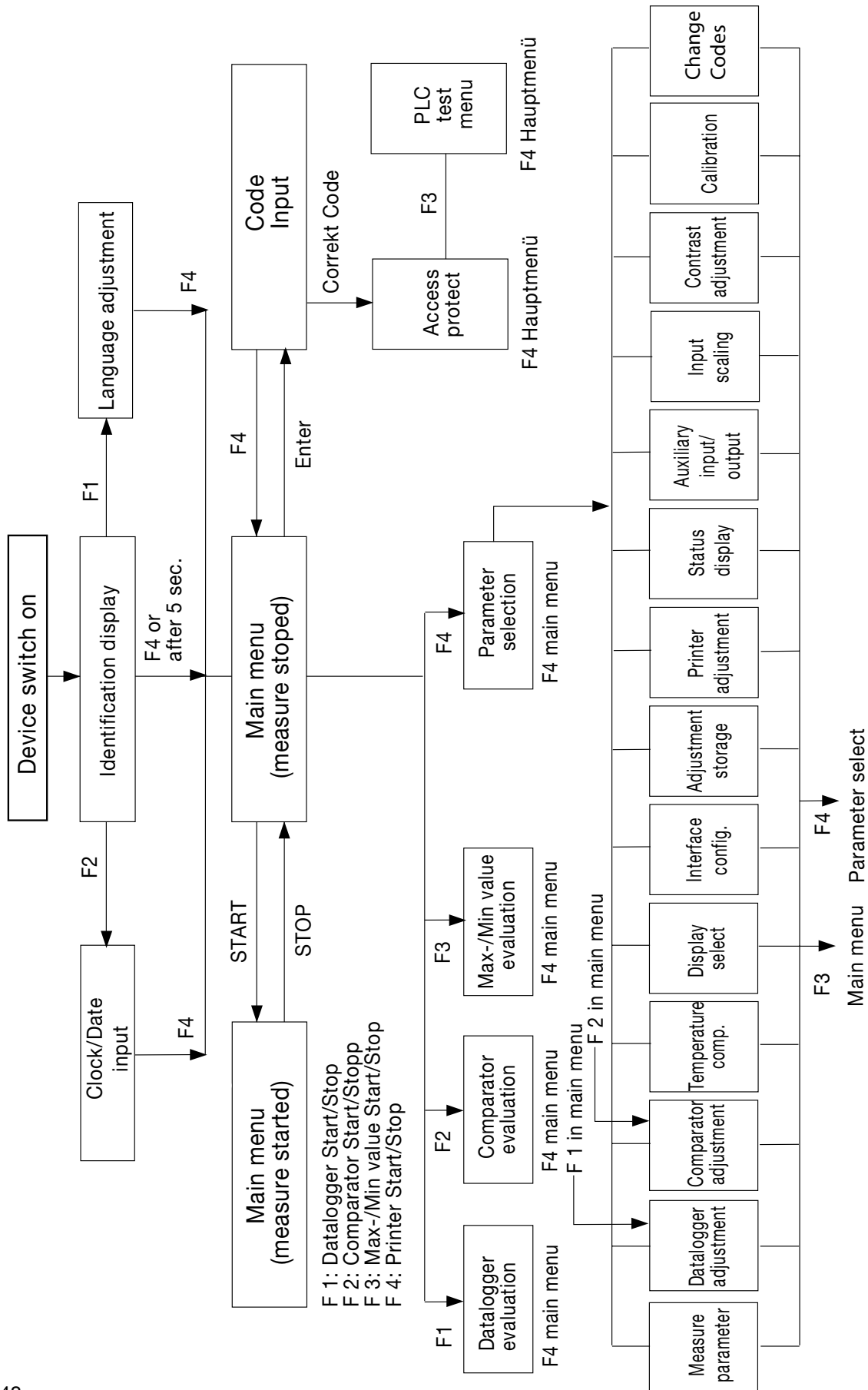

5.1.3 Measurement errors

Error tolerances and influence variables (for the standard procedure)

Resistance measurement (display range of 2000 and 20000):

Range	Measured value %	Conv.: Minimum Digits	Conv.: Medium Digits	Conv.: Standard Digits	Conv.: Maximum Digits
200 mΩ	0.03	± 4	± 3	± 2.5	± 2
2 Ω	0.03	± 4	± 3	± 2.5	± 2
20 Ω	0.03	± 4	± 3	± 2.5	± 2
200 Ω	0.03	± 4	± 3	± 2.5	± 2
2 kΩ	0.03	± 4	± 3	± 2.5	± 2
20 kΩ	0.03	± 4	± 3	± 2.5	± 2
200 kΩ	0.03	± 4	± 3	± 2.5	± 2

Temperature coefficient: 20 ppm/K Conv. = Conversion settings (see chapter 4.4.4.1)

20 mV mode

Resolution	Display ranges	Measured value %	Conv.: Minimum Digits	Conv.: Medium Digits	Conv.: Standard Digits	Conv.: Maximum Digits
2000	0.0 mΩ ... 200.000 mΩ	0.05	4	3	2.5	2
	0.200 Ω ... 2.000 Ω	0.05				
	2.00 Ω ... 4.09 Ω	0.1				
20000	0.00 mΩ ... 200.00 mΩ	0.05	4	3	2.5	2
	0.2000 Ω ... 0.6000 Ω	0.05				
	0.600 Ω ... 4.099 Ω	0.10				

Temperature coefficient: 20 ppm/K

In the 20 mV mode, the total resistance of the test object and the lines connected to it must amount to at least 200 mΩ. If this value is fallen short of, the measurement current becomes too high and the device outputs an error (current transmitter overloaded!). As the resistance increases, the measurement current drops and the measured results become more uncertain. ($I_{\min} = 1 \text{ mA}$, $I_{\max} = 100 \text{ mA}$)

Type	Error	TC	
*Pt100 (without sensor type)	0.07 K	20 ppm/K of ohmic value	I ca. 0.8 mA
U input	1.5 mV	25 ppm/K	$R_E > 100 \text{ k}\Omega$
I input	3 μA	20 ppm/K	$R_E < 20 \Omega$

*Error including measurement and linearization with respect to the DIN characteristic (range - 100 °C ... + 300 °C). The error of the temperature sensor is not included.

Analog output

- Analog output of the measurement amplifier (with respect to "-I" or analog ground). Error: 2.5 %, TC 80 ppm/K
- 10 V correspond to the maximum display value (except in the 20 mV mode). Capacity: ≤ 0.2 mA
- Output resistance: ≤ 0.1 Ω.

This output supplies the measurement signal (zero measurement - if active, cable-breakage test and measurement "ON"). This function is not recommended in the 20 mV mode, as the value of the measurement current is unknown here. As no specific current is used, only a part of the required information is available

5.1.4 Measurement rate

The RESISTOMAT® model 2329 was developed to allow quick and reliable measurements of ohmic resistances. The hardware and software are geared especially toward PLC-controlled measurements. The fastest measurements are achieved by triggering via a PLC or footswitch and evaluation of the results in combination with EOC. The single-frame measurement mode and manual range selection are used as a rule.

Every additional function increases the load on the process and reduces the achievable measurement rate.

Resolution range	20.000 C min	20.000 C med	20.000 C stand	20.000 C max	2.000 C min	2.000 C med	2.000 C stand	2.000 C max
200 mΩ	45 ms	78 ms	145 ms	276 ms	15 ms	20 ms	39 ms	91 ms
2 Ω	45 ms	78 ms	145 ms	276 ms	15 ms	20 ms	39 ms	91 ms
20 Ω	22 ms	40 ms	80 ms	145 ms	15 ms	20 ms	39 ms	65 ms
200 Ω	22 ms	40 ms	80 ms	145 ms	15 ms	20 ms	39 ms	65 ms
2 kΩ	30 ms	50 ms	80 ms	145 ms	15 ms	20 ms	39 ms	65 ms
20 kΩ	74 ms	95 ms	158 ms	263 ms	22 ms	26 ms	45 ms	72 ms
200 kΩ	283 ms	336 ms	442 ms	756 ms	76 ms	80 ms	100 ms	179 ms
20 mV	107 ms	187 ms	345 ms	660 ms	35 ms	55 ms	82 ms	240 ms

C = Conversion settings (see chapter 5.4.4.1)

Note:

All times were determined with the following settings:

Measurement procedure: Standard, "R" (identical to SINGLE-COMP during single-frame measurements).

No temperature compensation, no interface operation, no max.-min., no datalogger, no printer, no comparator.

Range selection: Manual

Times are measured from the falling edge of the footswitch to the rising edge of the PLC - EOC.

Internally, the free processor capacity is always made available to the measurement procedure. Every additionally activated function and every interface command (PLC, printer, RS232 and IEEE488) slows down the measurement.

Activating the temperature compensation slows down the measurement procedure.

The times must be determined with the following factors:

Range	Resolution 20.000	Resolution 2.000
200 mΩ	1.8	1.8
2 Ω	1.8	1.8
20 Ω	1.8	1.8
200 Ω	1.8	1.8
2 kΩ	1.8	1.8
20 kΩ	2.1	2.1
200 kΩ	2.5	2.5
20 mV	1.8	2.6

Measurement procedures without compensation (without a reference measurement) are faster. Times must be determined with the following factors:

Resolution range	20.000 C min	20.000 C med	20.000 C stand	20.000 C max	2.000 C min	2.000 C med	2.000 C stand	2.000 C max
200 mΩ	0.7	0.7	0.6	0.6	0.8	0.7	0.7	0.6
2 Ω	0.7	0.7	0.6	0.6	0.8	0.7	0.7	0.6
20 Ω	0.7	0.7	0.6	0.6	0.8	0.7	0.7	0.6
200 Ω	0.7	0.7	0.6	0.6	0.8	0.7	0.7	0.6
2 kΩ	0.7	0.7	0.6	0.6	0.8	0.7	0.7	0.6
20 kΩ	0.7	0.7	0.6	0.6	0.8	0.7	0.7	0.6
200 kΩ	0.7	0.7	0.6	0.6	0.8	0.7	0.7	0.6
20 mV	0.7	0.7	0.6	0.6	0.8	0.7	0.7	0.6

C = Conversion settings (see chapter 5.4.4.1)

The "REF-COMP" reference measurement

takes roughly the same time as the measurement without compensation.

The datalogger, comparator and max./min. recording

each take 0.5 ms longer.

The R and Z test settings

serve to match measurement procedures to long current-settling times caused primarily by inductive resistances.

For Z, the internal settling (or transient) times are increased by a factor of three and a waiting period elapses to allow the measurement current to stabilize. In this case, it is not possible to activate automatic range selection while a measurement is in progress, or activate the 20 mV mode.

If Z has been selected, ohmic resistances result in measurement times which are longer by a factor of 1.1 - 2, depending on the selected measurement range. In the event of an error, the time taken to detect cable-breakage rises to approximately 3 seconds, to allow the maximum charging time of the test object to elapse.

Errors occurring on the "R" setting

take approximately 4 ms to (1 ms + the standard measurement time) to detect, depending on their nature. In the case of extremely brief measurements, the time taken to detect cable-breakage is longer than the standard measurement time, as the waiting and evaluation times are added in this case.

With automatic range selection active, it might take very long to detect an interruption, as all the high ranges need to be checked first. For this reason, it is highly advisable to use manual range selection at testing stations involving short cycle times.

With REMOTE control active,

all additional program sections need to be interrogated internally. If PLC operation is involved, this prolongs the measurement times by the following factors:

Range	Factor
200 mΩ	1.2
2 Ω	1.2
20 Ω	1.2
200 Ω	1.2
2 kΩ	1.2
20 kΩ	1.4
200 kΩ	1.5
20 mV	1.4

With operation via an interface

(Init,Status:Operation:Event?,Fetch?,...), the measurement times depend heavily on the computer in use and the programming technique.

The faster the computer and the interface card, the more frequent the interruptions in the 2329's measurement process and the greater the drainage of its processing capacity.

Therefore, if a fast computer is in use, it should only be used to trigger the measurement and fetch the results once the measurement is complete.

With an RS232,

this can be achieved by configuring queues on the PC having the same magnitude as the expected measurement time. Subsequently, the status register can be used to determine whether the measurement is OK. If so, the measured value can be requested and read out. This is probably the fastest method.

Compared with standard PLC measurements without REMOTE control, the measurement time in this case increases by roughly 4 ms prior to a measurement (command decoding) and approximately 42 ms after the measurement (286/12 MHz, QBasic). The actual measurement time with constant scanning of the status register increases by approximately 25 %.

For example: Number 2000, fastest setting, standard procedure: 15 ms + 25 % + 4 ms + 42 ms = 65 ms.

Under identical conditions - but with the measurement-value display deactivated via a control command - the response time drops to roughly 22 ms after completion of a measurement.

For example: Number 2000, fastest setting, standard procedure: 15 ms + 25 % + 4 ms + 22 ms = 45 ms.

With an IEEE488,

the RESISTOMAT® model 2329 can be configured such that it triggers an SRQ on the completion of a measurement or the occurrence of a measurement error. This eliminates the need for constant polling during the actual measurement. With an IEEE488 and 286/12 MHz, QBasic and SRQ mode, the measurement time rises to roughly 2 ms before a measurement (command decoding) and roughly 3 ms after the measurement. The actual measurement is only prolonged by the REMOTE factor (see above).

For example: Number 2000, fastest setting, standard procedure: 15 ms + 20 % + 2 ms + 3 ms = 23 ms.

With an IEEE488 and constant polling of the status register,

the processor's capacity is heavily dependent on the performance of the PC processor, the IEEE488 card and the rate of program execution. This leads to incalculable delays. With a slow PC (286), a slow IEEE488 card and use of the QBasic interpreter, the measurement time increases by up to 40 %.

With an IEEE488 with 286/12 MHz, QBasic and continuous polling, the total measurement time is prolonged by approx. 2 ms before the actual measurement measurement (command decoding) and 9 ms following the actual measurement. The actual measurement time increases by up to 40 %. **This type of operation is extremely impractical.**

For example: 200 mΩ-range, number 2.000, fastest setting C_{min} , standard procedure:
 $15 \text{ ms} + 40 \% + 2 \text{ ms} + 9 \text{ ms} = 32 \text{ ms}.$

For example: 200 kΩ-range, number 20.000, fastest setting C_{max} , standard procedure:
 $756 \text{ ms} + 40 \% + 2 \text{ ms} + 9 \text{ ms} = 1.069 \text{ ms}.$

Under identical conditions, but with the measurement-value display deactivated via a control command, the response time following completion of a measurement does not decrease, because the RESISTOMAT® model 2329 has sufficient time to transfer the measurement result before it is displayed.

4.2. Identification menu

When the device is turned on, the following display appears:

RESISTOMAT TYPE 2329				
SN:		123456		→ Serial number
VERSION:		V201202		→ Software version
CAL:		C0001		→ Calibration date*
DATE:		16.12.13		→ Current date
TIME:		13:25:26		→ Current time
LANG	CLK	 	CONT	

Identification display following activation.

* The calibration number provides a count of the calibrations performed so far. This number also appears in the test log, and decisively determines whether or not the device needs to be reset.

This display appears for 5 seconds, unless a key is pressed in the meantime or a quick start (page 30) was activated.

Pressing the [F1] key (LANG) invokes the language menu where the required language can be selected.

Pressing the [F2] key (CLK) invokes the menu for setting the date and time.

Pressing the [F4] key (CONT) invokes the main menu.

If no key is pressed within 5 seconds following activation, the main menu is invoked.

5.2.1 Selecting a language

This menu is invoked by pressing the [F1] key while the identification menu is being displayed following activation of the device.

SELECT LANGUAGE			
LANGUAGE: ENGLISH			
			RETU

Language selection display

The operating language is selected in this menu.

The [←] and [→] cursor keys are used to select one of the following languages: GERMAN, ENGLISH, FRENCH. Pressing the [F4] key (RETUrn) saves the language setting and effects a return to the main menu.

5.2.2 Setting the date and time

DATE AND TIME			
DATE: 16.12.2018			
TIME: 15.24.35			
INPUT			RETU

Display of the menu for setting the date and time

The [↑] and [↓] cursor keys are used to select the required parameter. The selected parameter is displayed inversely.

The [POS1] key is used to select the 1st parameter in a window.

The [END] key is used to select the last parameter in a window.

A new value for the selected parameter can now be entered. Pressing the [F 1] key (INPUT) invokes the input mode.

Numeric keys [0] to [9] are used to enter the date and time.

The [BSP] key is used to delete the character entered last.

The [C] key is used to delete all the entered characters and repeat the input procedure from the beginning, without exiting the input mode.

The [ESC] key is used to cancel the current entry, and exit the input mode.

The [ENT] key is used to save the input value - provided that it is valid - and exit the input mode.

Pressing the [F4] key (RETUrn) saves the set date and time - provided that they are valid - and effects a return to the main menu.

5.3 Main menu

5.3.1 Measurement stopped

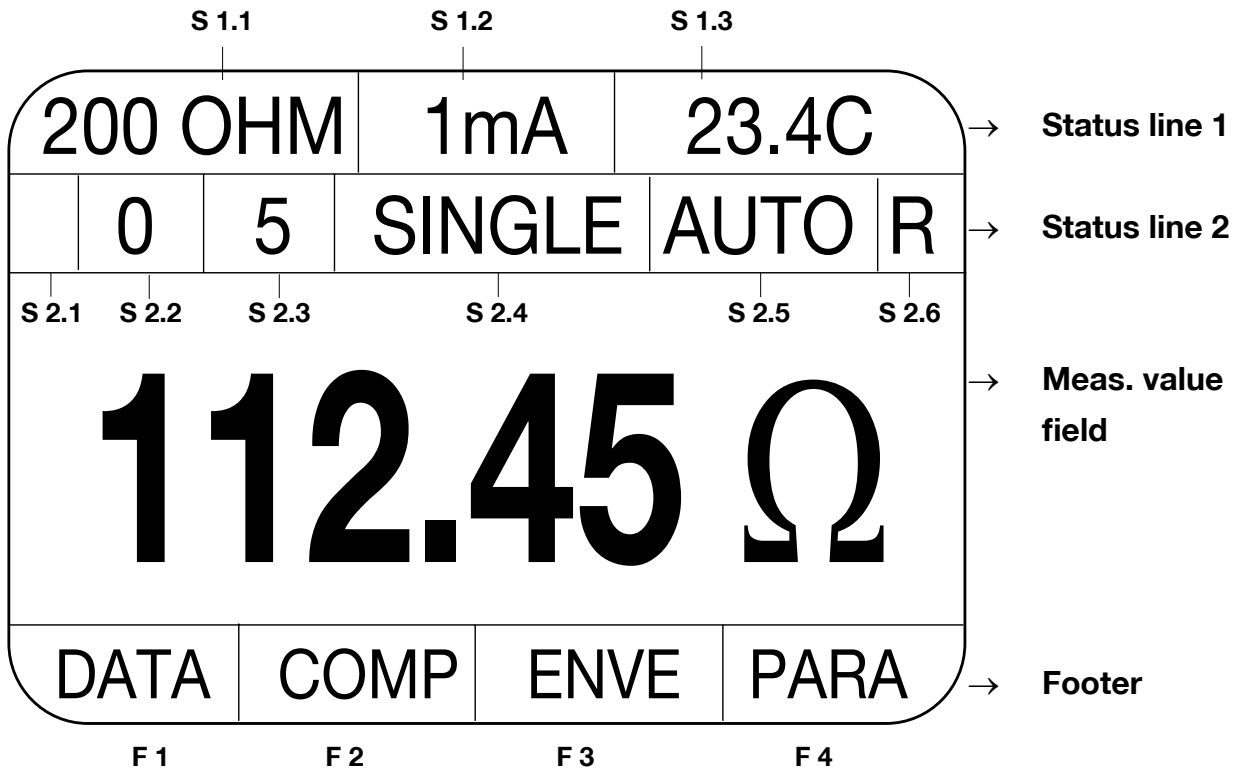

Display with a measurement stopped

Display in status line 1:

- S 1.1 Measuring range
- S 1.2 Measuring current or 20 mV with dry-circuit measurement
- S 1.3 Temperature with temperature compensation or setpoint value with Δ % display

Display in status line 2:

- S 2.1 Sample character (a sequential number from 0 to 9, only while a measurement is in progress)
- S 2.2 Error status (see page 138) or comparator evaluation
- S 2.3 The memory number loaded last
- S 2.4 Continuous or single-frame measurement
- S 2.5 Manual or automatic range selection
- S 2.6 R or Z measurement procedure

Display in the measurement-value field: The value measured last

Display in the footer: Designation of the function keys

The following entries are possible in this menu:

- [F1] key (DATA): This invokes the datalogger evaluation and configuration menus.
- [F2] key (COMP): This invokes the comparator evaluation and configuration menus.
- [F3] key (ENVE): This invokes the max./min, evaluation menu.
- [F4] key (PARA): This invokes the parameter selection menu.

- [ENT] key: Pressing the ENTER key invokes the code input menu.
- [START] key: Pressing this key commences a measurement.
- [A/M] key: This key is used to switch over between automatic and manual range selection.

The [RGE \uparrow] and [RGE \downarrow] keys are used to select ranges manually in the corresponding mode (not in the case of dry-circuit measurements).

5.3.2 Measurement started

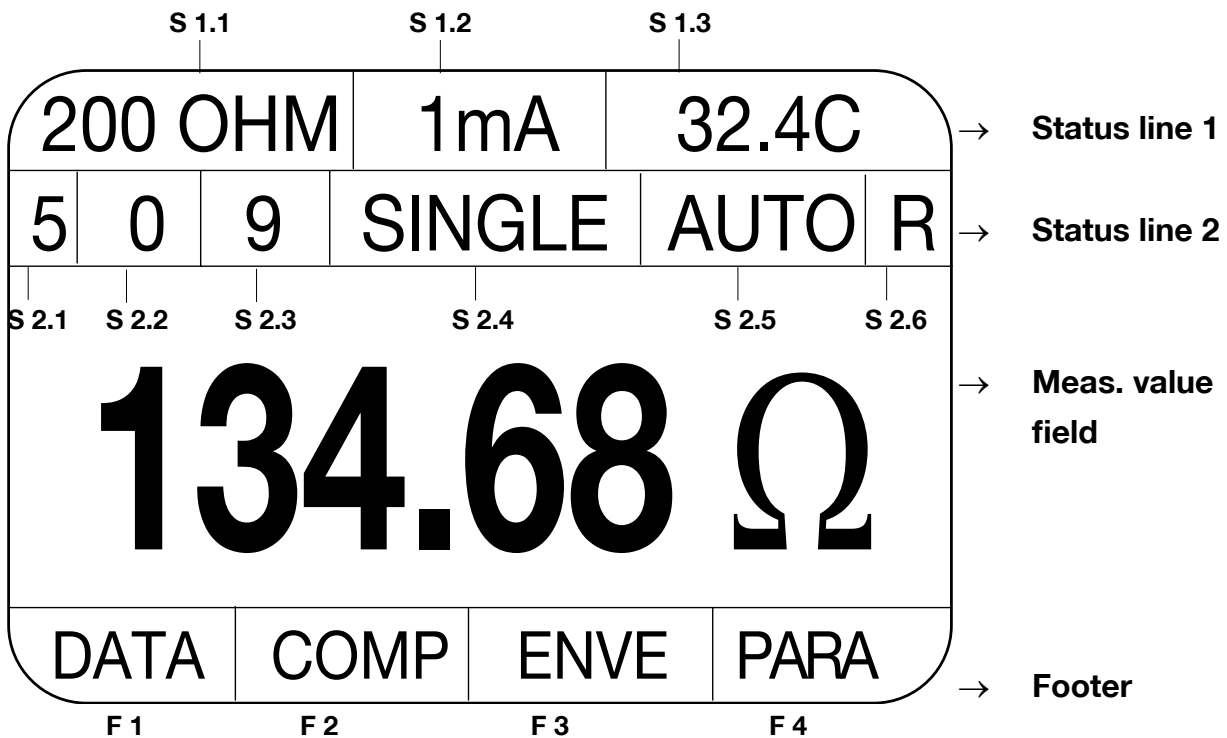

Display with a measurement in progress

- | | | | |
|---------------------------|-------|-------------------------------------------------------------------------------------|------------------------------------------------------------|
| Display in status line 1: | S 1.1 | Measuring range | |
| | S 1.2 | Measuring current or 20 mV with dry-circuit measurement | |
| | S 1.3 | Temperature with temperature compensation or setpoint value with Δ % display | |
| Display in status line 2: | S 2.1 | Sample character (a sequential number from 0 to 9) | |
| | S 2.2 | Error status (see page 138) or comparator evaluation | |
| | S 2.3 | The memory number loaded last | |
| | S 2.4 | Continuous or single-frame measurement | |
| | S 2.5 | Manual or automatic range selection | |
| | S 2.6 | R or Z measurement procedure | R = purely ohmic load
Z = load with inductive component |

Display in the measurement-value field: Present measurement value

Display in the footer: Designation of the function keys

The following entries are possible in this menu:

- F1 key [DATA]: This starts/stops the datalogger if the datalogger setting menu has been released for access (page 42). When the datalogger is operating, the [F1] key designation is displayed inversely.
- F2 key [COMP]: This starts/stops the datalogger if the comparator setting menu has been released for access (page 45). When the comparator is operating, the [F2] key designation is displayed inversely.
- F3 key [ENVE]: This starts/stops the recording of max./min. values if the corresponding function has been released for access (page 35). While max./min. values are being recorded, the [F3] key designation is displayed inversely.
- F4 key [PRINT]: This starts/stops the printer if the printer configuration menu has been released for access (page 55). When the datalogger is operating, the [F4] key designation is displayed inversely.
- [STOP] : The present measurement is stopped.
- [RGE ↑] and (RGE ↓): These keys are used to select ranges in the manual mode if R has been set (not in the case of dry-circuit measurements).

5.3.3 Code input menu

This menu is invoked by pressing the [ENT] key in the main menu while a measurement is stopped.

CODE INPUT			
PLEASE ENTER CODE			
4 NUMBERS: ****			
			RETU

Display of the code input menu

This menu is used to enter a 4 digits code in order to invoke the access menu (2609) or put the RESISTOMAT® model 2329 into a defined state (9062) with the default values applying at the time of delivery. The preselected codes can be changed in the change codes menu.

Various items can be enabled and disabled in the access menu. Items marked with an asterisk (*) are in the enabled state.

If the RESISTOMAT® model 2329 is put into a defined state using the code, so that the default values are restored, all user settings are deleted.

The code is entered with numeric keys [0] to [9].

Each numeric entry is confirmed by the display of an asterisk (*).

In accordance with the entered code, the access menu is invoked or the RESISTOMAT® model 2329 assumes a defined, initial state.

The [ESC] key is used to cancel a code entry procedure.

Pressing the [F4]key (RETurn) effects a return to the main menu.

5.3.3.1 Access menu

This menu is invoked following the entry of the correct code in the code input menu (chapter 5.3.3).

ACCESS			S 1
* MEAS. PARAMETER			
* DISPLAY			
COMPARATOR CONF.			
COMPARATOR EVAL.			
ON	OFF	PLC	RETU

Display of the access menu (page 1)

ACCESS			S 2
<ul style="list-style-type: none"> * PRINTER * TEMPERATURE COMP. CALIBRATION * MAN. RANGE SELECT 			
ON	OFF	PLC	RETU

Display of the access menu (page 2)

ACCESS			S 3
<ul style="list-style-type: none"> * SCALED INPUT * DATALOGGER CONF. MAX/MIN RESET CONTRAST 			
ON	OFF	PLC	RETU

Display of the access menu (page 3)

ACCESS			S 4
<ul style="list-style-type: none"> * DISPLAY STATUS AUX. INPUT/OUTPUT MAX/MIN START * DATE/TIME 			
ON	OFF	PLC	RETU

Display of the access menu (page 4)

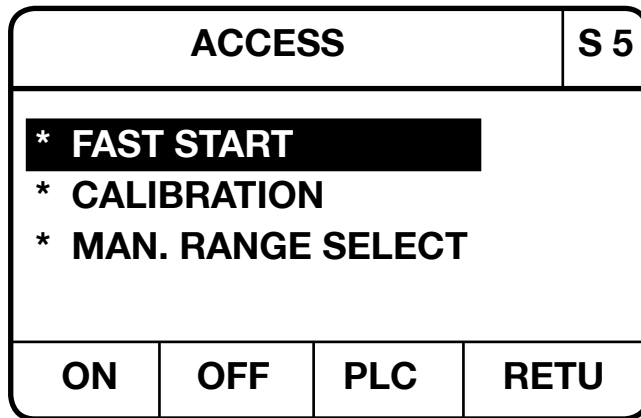

Display of the access menu (page 5)

Access to various other menus is enabled and disabled in this menu.

The following entries are possible in this menu:

- [F1] key (ON): The selected menu is enabled and marked with an asterisk .
- [F2] key (OFF): The selected menu is disabled.
- [F3] key (PLC): The PLC test menu is invoked.
- [F4] key (RETUrn): This effects a return to the main menu.

The [▲] and [▼] keys are used to switch between the various pages.

The [↑] and [↓] cursor keys are used to select the required parameter on the current page. The selected parameter is displayed inversely.

The [POS1] key is used to select the 1st parameter in a window.
 The [END] key is used to select the last parameter in a window.

The MAN. RANGE SELECTION parameter (on page 5 of the menu) is enabled and disabled from the main menu using the RGE ↑ and RGE ↓ keys respectively.

5.3.3.2 Test PLC inputs and outputs

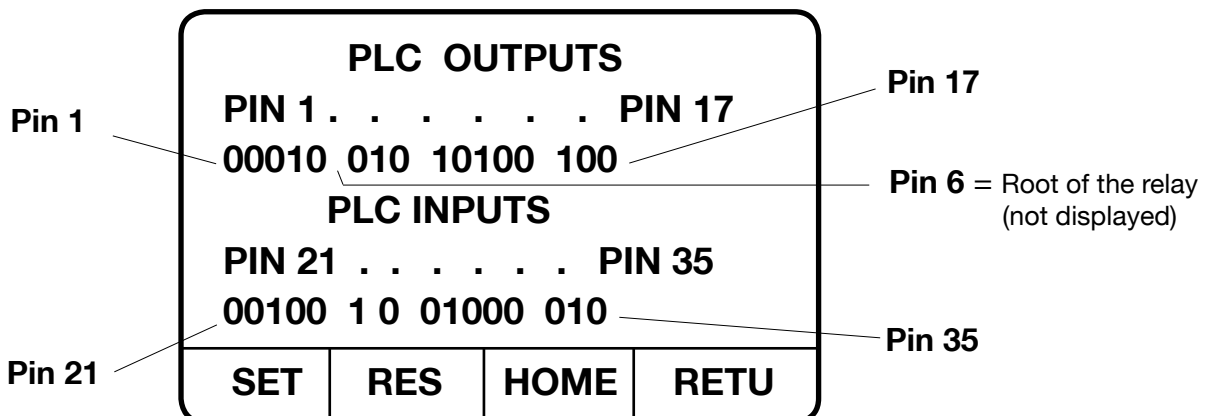

This menu is used to test the PLC interface. The input levels are indicated, and the output levels can be set and reset here.

This menu is invoked with the [F3] key (PLC) from the access menu.

The signals are present at the 37- pole SUB-MIN-D socket.

The inputs and outputs need to be connected and supplied from an external source. Pulse diagrams and pin assignments are provided in the chapter on the PLC interface on page 71.

The 16 outputs are allocated to pins 1 to 17.

Output sequence:

S0, S1, S2, S3, S4
 MEAS-RUN, MEAS-END, MEAS-ERR
 EV1, EV2, EV3, EV4, EV5
 OUT-AUX1, OUT-AUX2, OUT-AUX3

The 15 inputs are allocated to pins 21 to 35.

Input sequence:

MEAS-1/0, COMP-1/0, DATA-1/0, EXT-1/0, DRU-1/0
 LATCH, IN-AUX1, IN-AUX2, IN-AUX3, IN-AUX4,
 SET0, SET1, SET2, SET3, SET4

Description and pin assignment chapter Block diagram page 18.

[F3] key (HOME): This effects a return to the main menu.

[F4] key (RETUrn): This effects a return to the access menu.

The [→] and [←] cursor keys are used to select the individual output pins.

The selected pin is displayed inversely.

[F1] key (SET): The selected output pin is set to 1.

[F2] key (RES): The selected output pin is reset to 0.

5.4. Function keys while a measurement is stopped

5.4.1 Datalogger evaluation menu

5.4.1.1 Display of the individual measurement values

BLOCK: 12		DATALOG.: 12	
MEAS.		NUMBER: 15	
MEAS. VAL.:		123.45 mOHM	
SIZE:		625 (18)	
DATE:		01.08.18	
TIME:		13:12:15.34	
INPUT	STAT	CONF	RETU

Display of the
datalogger evaluation menu
(display of the individual
measurement values)

The values stored in the datalogger can be viewed individually in this menu.

The following entries are possible:

[F4] key (RETUrn): This effects a return to the main menu.
 [F3] key (CONF): This invokes the datalogger setting menu.
 [F2] key (STAT): This invokes the datalogger evaluation menu.

The [↑] and [↓] cursor keys are used to select the required parameter. The selected parameter is displayed inversely. Only the selected parameter can be changed.

The [POS1] key is used to select the 1st parameter in a window.
 The [END] key is used to select the last parameter in a window.

Specifying the **MEAS**urement **NUMBER**:

The [→] and [←] cursor keys are used to increment and decrement the measurement value number.

Pressing the [F 1] key (INPUT) invokes the input mode.

Numeric keys [0] to [9] are used to enter a measurement-value number between 1 and 20000.

The [BSP] key is used to delete the character entered last.

The [C] key is used to delete all the entered characters and repeat the input procedure from the beginning, without exiting the input mode.

The [ESC] key is used to cancel the current entry, and exit the input mode.

The [ENT] key is used to save the input value - provided that it is valid - and exit the input mode.

Specifying the **Block** number:

The [→] and [←] cursor keys are used to increment and decrement the block number.

Pressing the [F1] key (INPUT) invokes the input mode.

Numeric keys [0] to [9] are used to enter a block number ranging between 0 and 31.

The [BSP] key is used to delete the character entered last.

The [C] key is used to delete all the entered characters and repeat the input procedure from the beginning, without exiting the input mode.

The [ESC] key is used to cancel the current entry, and exit the input mode.

The [ENT] key is used to save the input value - provided that it is valid - and exit the input mode.

The [F2] key (STAT) is used to invoke the stochastic datalogger evaluation menu.

Note: The memory is capable of holding 20000 measurement values. A measurement value can be invoked and displayed by entering the corresponding number or by using the [→] and [←] cursor keys.

The memory capacity of 20000 measurement values can be divided into 32 differently sized blocks.

The "SIZE" parameter indicates the number of memory locations reserved for a block (e.g. 625) followed - in parentheses - by the number of measurement values currently stored in this block (e.g. 18).

The measurement values in a block can be evaluated statistically. The minimum, maximum and average values as well as the standard deviation can be displayed (chapter. 4.4.1.2). In addition to a number ranging from 0 ... 31, every block can also be assigned a 10 character ID (numeric entry via the keypad, alphanumeric entry via a PC).

5.4.1.2 Stochastic datalogger evaluation menu

BLOCK: 12		DATALOG 12	
AVERAGE:		123.46 mOHM	
MINIMUM:		122.31 mOHM	
MAXIMUM:		124.18 mOHM	
DEVIATION:		5.26 mOHM	
SIZE:		625 (18)	
INPUT	MEAS	CONF	RETU

Display of the stochastic datalogger evaluation menu

This menu is used for the stochastic evaluation of individual datalogger blocks.

The following entries are possible:

[F4] key (RETURN): This effects a return to the main menu.

[F3] key (CONF): This invokes the datalogger setting menu.

Specifying the **Block** number:

The [→] and [←] cursor keys are used to increment and decrement the block number.

Pressing the [F1] key (INPUT) invokes the input mode.

Numeric keys [0] to [9] are used to enter a block number ranging between 0 and 31.

The [BSP] key is used to delete the character entered last.

The [C] key is used to delete all the entered characters and repeat the input procedure from the beginning, without exiting the input mode.

The [ESC] key is used to cancel the current entry, and exit the input mode.

The [ENT] key is used to save the input value - provided that it is valid - and exit the input mode.

The [F2] key (MEAS) invokes the datalogger evaluation menu for displaying individual measurement values.

5.4.2 Comparator evaluation menu

<<:	2		
< :	9		
= :	126		
> :	10		
>>:	4		
SUM:	151		
RES	LIM	CONF	RETU

Comparator
evaluation menu
(with 4 limiting values)

< :	9		
= :	126		
> :	10		
SUM:	145		
RES	LIM	CONF	RETU

Comparator
evaluation menu
(with 2 limiting values)

- With 2 limiting values:

< :	All values	<	Limiting value 1	
= :	All values	≧	Limiting value 1 and	≦ limiting value 2
> :	All values	>	Limiting value 2	

- With 4 limiting values:

<< :	All values	<	Limiting value 1	
< :	All values	≧	Limiting value 1 and	< than limiting value 2
= :	All values	≧	Limiting value 2 and	≧ than limiting value 3
> :	All values	>	Limiting value 3 and	≦ than limiting value 4
>> :	All values	>	Limiting value 4	

The following entries are possible:

The [F4] key (RETUrn)	effects a return to the main menu
The [F1] key (RESet)	resets the current statistical values
The [F3] key (CONF)	invokes page 1 of the comparator setting menu (page 46)
The [F2] key (LIM)	invokes page 2 of the comparator setting menu (page 47)

5.4.3 Max/Min evaluation menu

MAX/MIN FUNCTION			
MAX/MIN :		OFF	
MINIMUM :		123.45 OHM	
MAXIMUM :		124.10 OHM	
DIFF:		0.65 OHM	
RES			RETU

Display of
max/min-
evaluation menu

The following entries are possible:

The [F1] key (RES) is used to reset the values.

The [F4] key (RETUrn) effects a return to the main menu.

The [→] and [←] cursor keys are used to activate and deactivate the MAX/MIN function.

5.4.4 Parameter selection menu

MEAS. PARAMETER			S 1
DISPLAY			
COMPARATOR CONFIG.			
DATALOGGER CONFIG			
PRINTER			
TEMPERATURE COMP.			
SEL			RETU

Display of the
parameter selection menu
(page 1)

INTERFACES			S 2
STORE CONFIG.			
DISPLAY STATUS			
AUX. INPUT/OUTPUT			
SCALED INPUTS			
CONTRAST			
SEL			RETU

Display of the
parameter selection menu
(page 2)

CALIBRATION			S 3
CHANGE CODES			
SEL			RETU

Display of the parameter selection menu (page 2)

This menu is used to select other menus.

The following entries are possible:

The [F4] key (RETUrn) effects a return to the main menu.

This menu display covers 3 pages.

The [↑] and [↓] cursor keys are used to select the required parameter on the current page. The selected parameter is displayed inversely.

The [POS1] key is used to select the 1st parameter in a window.

The [END] key is used to select the last parameter in a window.

Pressing the [F1] key (SElect) invokes the menu related to the selected parameter.

5.4.4.1 Measurement parameter menu

MEAS. PARAMETER			S 1
SELECT RANGE:		MAN	
MEAS. RANGE:	200 mOHM		
LOAD:	R		
MEAS. MODE:	SINGLE		
		HOME	RETU

Display of the measurement parameter menu (page 1)

MEAS. PARAMETER			S 2
AVERAGE:		100	
AVER. MODE:	CONT		
RESOLUTION:	2000		
20 mV LIMITING:	OFF		
INPUT		HOME	RETU

Display of the measurement parameter menu (page 2)

MEAS. PARAMETER		S 3	
A/D CONV:		STANDARD	
MEAS. -SQ.:		SINGLE COMP.	
INPUT		HOME	RETU

Display of the measurement parameter menu (page 3)

Various measurement parameters can be set in this menu.

The following entries are permissible:

The [F3] key (HOME) effects a return to the main menu.

The [F4] key (RETUrn) effects a return to the parameter selection menu.

This menu display covers 3 pages.

The [▲] and [▼] keys are used to switch between the three pages.

The [↑] and [↓] cursor keys are used to select the required parameter on the current page. The selected parameter is displayed inversely.

The [POS1] key is used to select the 1st parameter in a window.

The [END] key is used to select the last parameter in a window.

Specifying the SELECT RANGE

The [→] and [←] cursor keys are used to select one of the following options:

MAN: The measuring range must be selected manually.

AUTO: The RESISTOMAT® model 2329 automatically selects the appropriate measuring range.

On a change from MAN to AUTO, the RESISTOMAT® model 2329 first selects the 200 kOHM range.

A change between MAN and AUTO can also be made with the A/M key in the main menu.

The following display appears in the AUTO mode:

MEAS. PARAMETER		S 1	
SELECT RANGR:		AUTO	
MIN. RGE:		200 mOHM	
LOAD:		R	
MEAS. MODE:		SINGLE	
	A-HI	HOME	RETU

Display of the measurement parameter menu (page 1) when AUTO is selected

When automatic range selection is active, the permissible measuring ranges can be limited in order to optimize the measurement rate.

For example: A - HI = 200 Ω
A - LO = 2 Ω

With these settings, the RESISTOMAT® model 2329 only measures in the 2 Ω, 20 Ω and 200 Ω ranges.

The currently smallest measuring range is indicated.

Pressing the [F2] key (A-HI) displays the largest permissible measuring range. The F2 field is cleared and the F1 field is marked with (A-LO). Pressing the [F1] key effects a return to the display of the smallest permissible measuring range. The smallest/largest measuring ranges can be adjusted with the [→] and [←] cursor keys. A prerequisite here is that the smallest measuring range must always be smaller than the largest measuring range.

Selecting the **MEAS**uring **RANGE** in the MANual mode

The [→] and [←] cursor keys are used to select the required measuring range in the manual mode. The measuring range can also be selected with the [RGE↑] and [RGE↓] keys in the main menu. This is also possible while a measurement is in progress, if R has been set.

Possible measuring ranges: 200 mOHM, 2 OHM, 20 OHM, 200 OHM, 2 KOHM, 20 KOHM and 200 KOHM.

Selecting the **TEST OBJECT**

The [→] and [←] cursor keys are used to select one of the following options:

- R Measurement procedure for purely ohmic loads
- Z Measurement procedure for loads with an inductive component, such as coils, transformers and motor windings.

Selecting the **MEAS**urement **MODE**

The [→] and [←] cursor keys are used to select one of the following options:

- SINGLE The RESISTOMAT® model 2329 only performs one single measurement.
- CONTINUOUS The RESISTOMAT® model 2329 continues performing measurements until it is stopped.

Specifying the number of **AVERAGES**

Pressing the [F1] key (INPUT) invokes the input mode.

Numeric keys [0] to [9] are used to specify the number of average values.

The [BSP] key is used to delete the character entered last.

The [C] key is used to delete all the entered characters and repeat the input procedure from the beginning, without exiting the input mode.

The [ESC] key is used to cancel the current entry, and exit the input mode.

The [ENT] key is used to save the input value - provided that it is valid - and exit the input mode.

Selecting the type of **INDICATION**

The [→] and [←] cursor keys are used to set one of the following options:

- MOVING A moving average value is indicated on every conversion.
- REFRESH The average value is formed from the set number of measurement values in each case and output subsequently.

Note

REFRESH means that with a set number of 10, a new average value is displayed every 10 measurements. The first time an average value is formed, an S is displayed by the measurement-value counter (see chapter. 4.3.1.); the subsequent average values are counted from 0 to 9 etc.

MOVING means that with a set number of 10, a new average value is displayed 10 measurements following the start of a measurement or the occurrence of a measurement error (as described above). On every further internal measurement, the values are used to form a new average value which is then displayed.

Specifying the **RESOLUTION**

The [→] and [←] cursor keys are used to set one of the following options:

- 20000 Resolution of 20000 (4 1/2 digit display).
- 2000 Resolution of 2000 (3 1/2 digit display).

Specifying the **20 mV LIMIT**

The [→] and [←] cursor keys are used to set one of the following options:

- ON The 20 mV limit is active.
- OFF The 20 mV limit is inactive.

Note

Dry-circuit measurement in accordance with DIN IEC 512 Part 2:

Dry-circuit measurements and the 20 mV technique are always used for testing switches and plugs which operate at low voltages.

To verify the proper transfer of signals by plugs and switches, any extraneous layers which have formed must not be allowed to decompose during the measurement.

DIN IEC 512 Part 2 stipulate a maximum test voltage of 20 mV.

In the 20 mV mode, the total resistance of the test object and the lines connected to it must amount to at least 200 mΩ.

If this value is fallen short of, the measurement current becomes too high and the RESISTOMAT® model 2329 outputs an error (current transmitter overloaded!). As the resistance increases, the measurement current drops and the measured results become more uncertain, as the load on the A/D converter decreases.

The analog output cannot be used in the 20 mV mode (refer to measurement errors in chapter. 5.1.3).

Only one measuring range is available for dry-circuit measurements.

Only the display format is switched in accordance with the internal measurement resolution.

Specifying the number of **CONV**ersions for the A/D converter

The [→] and [←] cursor keys are used to set one of the following values:

- MINIMUM Lowest number of conversions.
- MEDIUM 2nd lowest number of conversions.
- STANDARD 2nd highest number of conversions.
- MAXIMAL Highest number of conversions.
- ITEST Measurement current monitoring (continuity tester)

Note

This RESISTOMAT® model 2329 is equipped with a very fast AD converter whose conversion time can be adjusted over 4 stages.

The conversion time of each stage depends on the selected measurement range and resolution (refer to the measurement rate in chapter. 5.1.4)

Specifying the **MEAS**urement **PROC**edure

The [→] and [←] cursor keys are used to select one of the following options:

- REF-COMP Zero measurement for compensation of thermoelectric potentials.
- NO COMP No zero measurement (the values of the reference measurement are used).
- SINGLE COMP A zero measurement is only performed once at the start.
- STANDARD A zero measurement and a measurement with I or U are performed alternately.
- I-Test Measurement current monitoring (continuity tester).

Note :

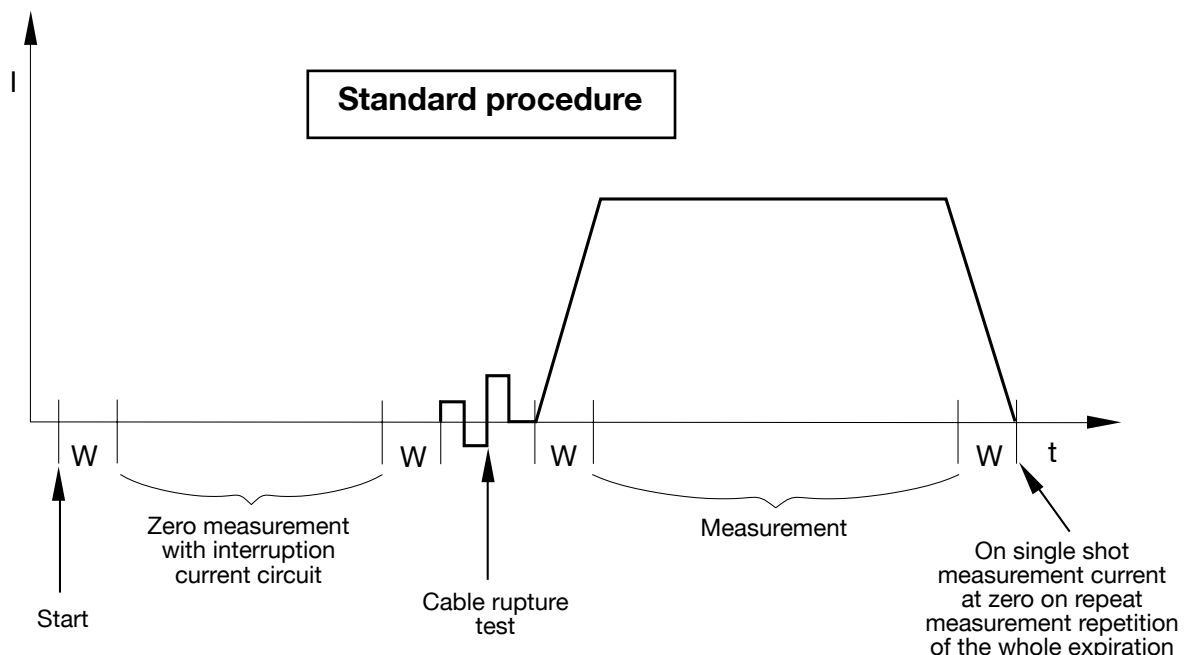

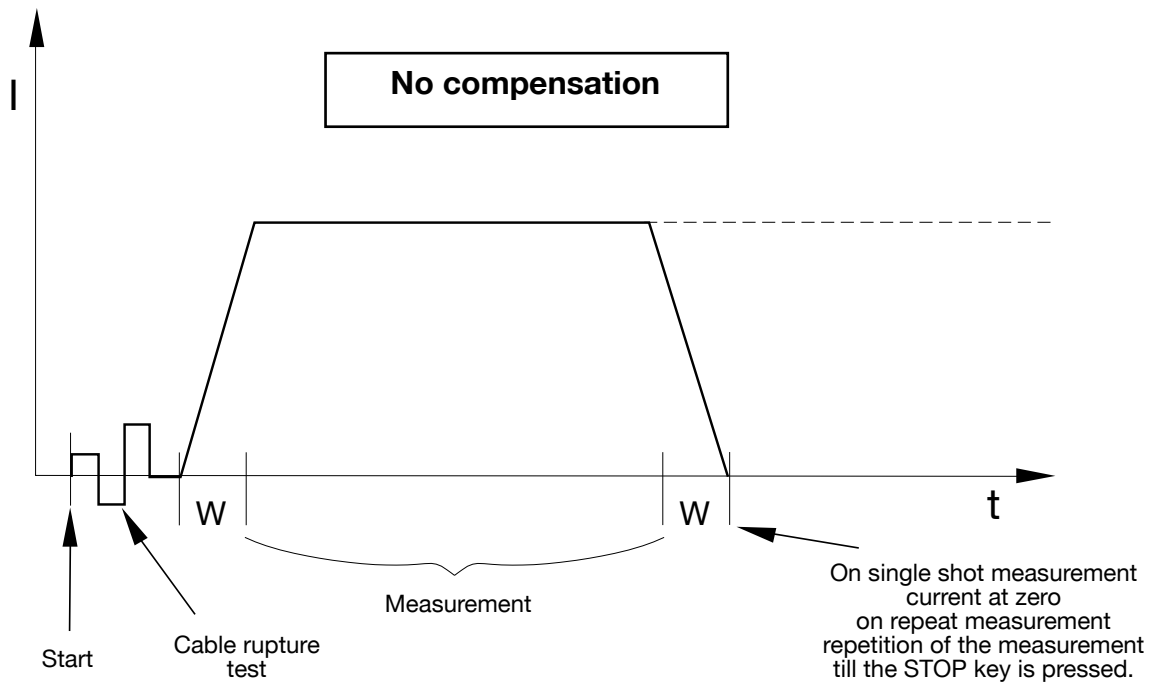
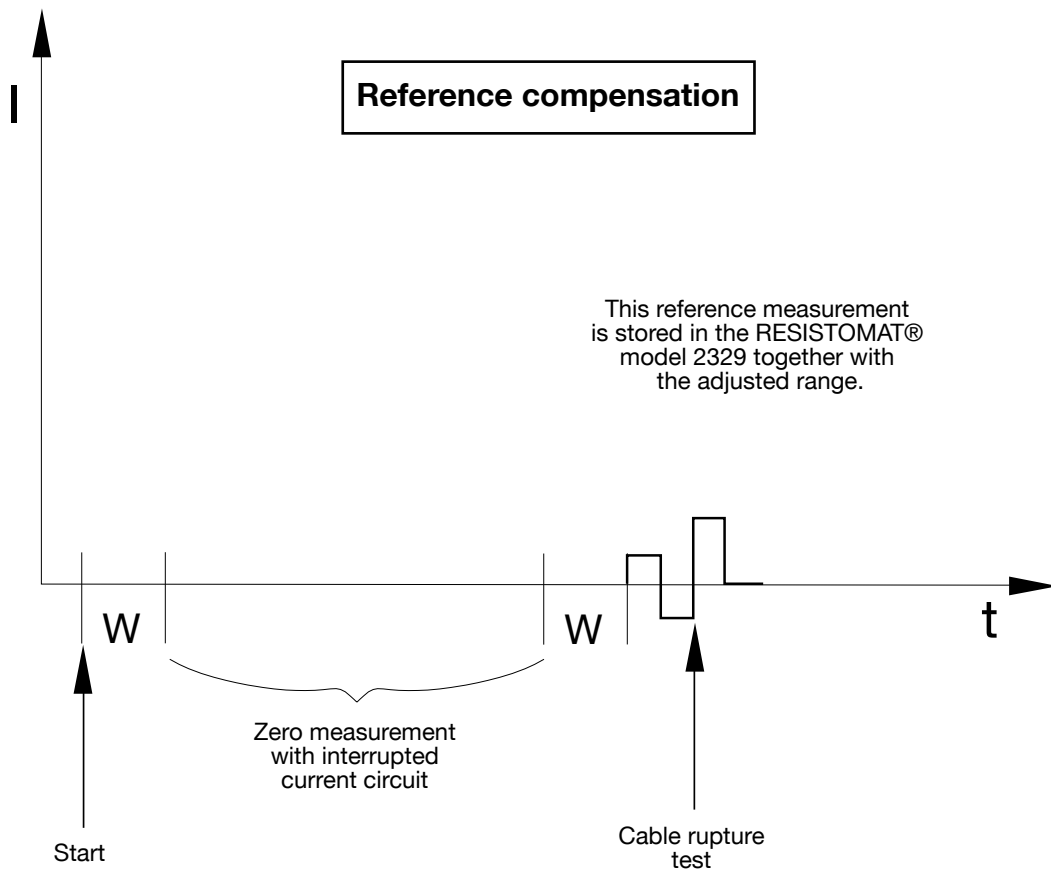

The values of the last reference measurement in the corresponding range are used to calculate the resistance.

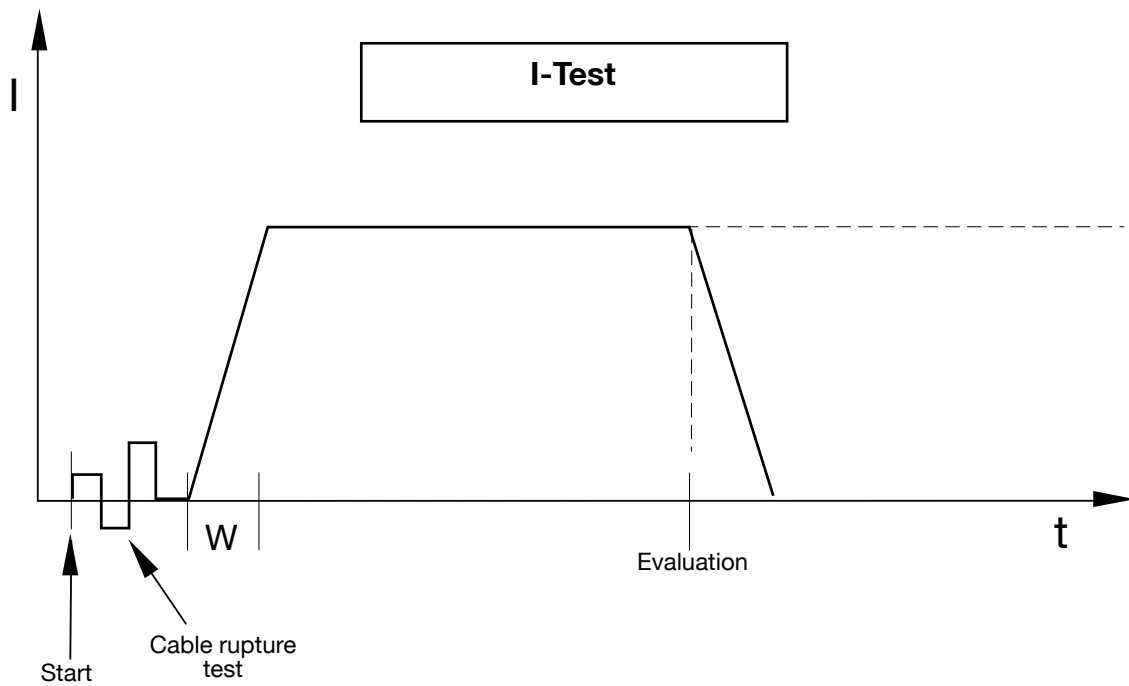
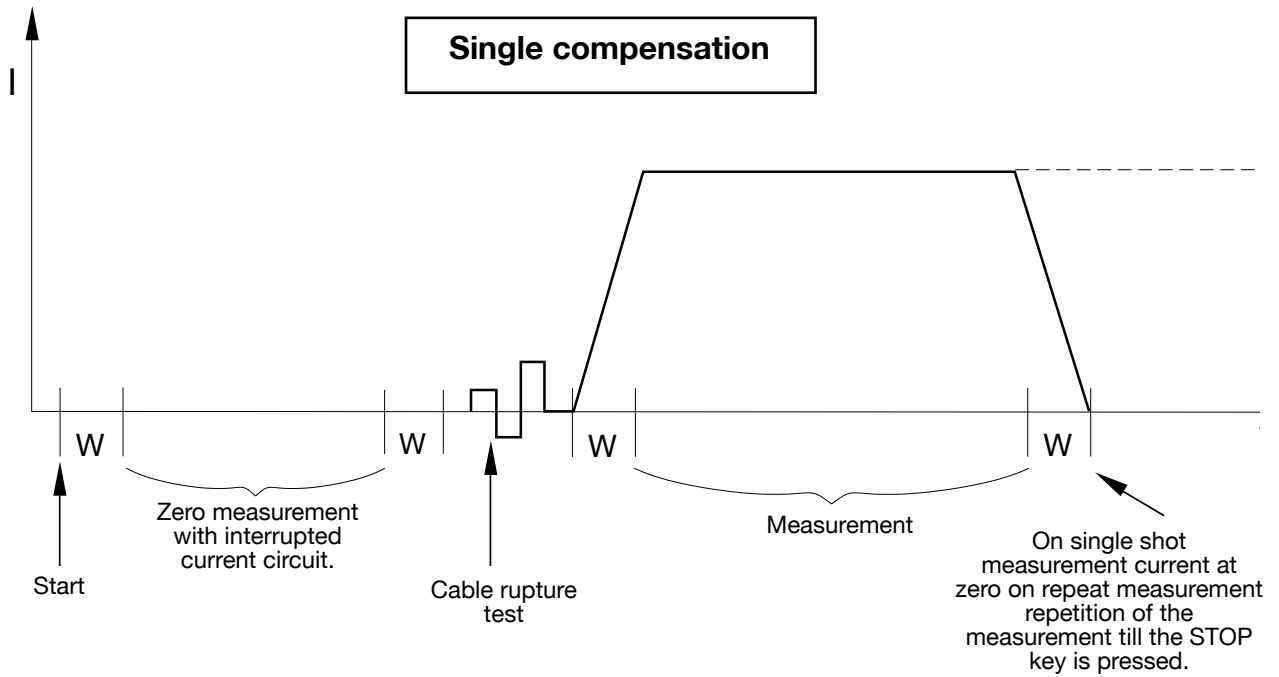

This measurement procedure is only a measurement current monitoring (continuity tester).
 If the measurement current is o.k. you get at the display a large = in the meas. value field.

If the meas. current is too less or zero you get at the display a large > in the meas. value field.
 The meas. range (meas. current) depends of the resistance of the test object.

At this meas. mode only manual range selection is possible. After a stable meas. current ensue the evaluation:

- 1.) At 2 comparator limits = -> meas. current o.k.
 > -> meas. current not o.k.

Corresponding the PLC-signal will set.

- 2.) At 4 comparator limits = -> meas. current o.k.
 >> -> meas. current not o.k.

Corresponding the PLC-signal will set.

This meas. mode you can also select via RS232 or IEEE488 interface with the instruction code FRES:MODE:ITEST. The meas. rate depends of the conversion settings.

	C _{MINIMUM}	C _{MEDIUM}	C _{STANDARD}	C _{MAXIMAL}
Meas. time at single shot and the 1. meas at continuous meas.	13 ms	21.5 ms	30 ms	37.5 ms
Meas. time from 2. meas. at continuous meas.	16 ms	32 ms	50.5	63.5 ms

C = Conversion settings (see chapter 4.4.4.1)

5.4.4.2 Datalogger setting menu

AVAIL MEMORY: 8230			
DATALOGGER: OFF			
BLOCK:	2	1234567890	
SIZE:	100	(18)	
FILTER:	ALL		
DELETE:	BLOCK		
INPUT		HOME	RETU

Display of the datalogger setting menu

The parameters for the datalogger are set in this menu.

The following entries are possible:

- [F3] key (HOME): This effects a return to the main menu.
 [F4] key (RETUrn): This effects a return to the parameter selection menu or the datalogger evaluation menu, depending on where the present menu was invoked from.

The [↑] and [↓] cursor keys are used to select the various parameters in the menu. The selected parameter is displayed inversely. Only the selected parameter can be changed.

The [POS1] key is used to select the 1st parameter in the window.
The [END] key is used to select the last parameter in the window.

The size of the **available memory** which has not yet been assigned to a block is indicated.
The **DATALOGGER** can be activated and deactivated with the [→] and [←] cursor keys respectively.

Specifying a **BLOCK**:

The BLOCK parameter consists of two values: The block number and an ID with a maximum length of 10 digits.

The [←] and [→] cursor keys are used to select the block number and ID. The selected value is displayed inversely. Only the selected value can be changed.

Specifying a BLOCK number:

Pressing the [F1] key (INPUT) invokes the input mode.

Numeric keys [0] to [9] are used to enter a value between 0 and 31 for the block number.

The [BSP] key is used to delete the character entered last.

The [C] key is used to delete all the entered characters and repeat the input procedure from the beginning, without exiting the input mode.

The [ESC] key is used to cancel the current entry, and exit the input mode.

The [ENT] key is used to save the input value - provided that it is valid - and exit the input mode.

Specification a BLOCK ID:

Pressing the [F1] key (INPUT) invokes the input mode.

Numeric keys [0] to [9] and the [.] key are used to enter the block ID.

The same ID cannot be assigned to more than one block.

The [BSP] key is used to delete the character entered last.

The [C] key is used to delete all the entered characters and repeat the input procedure from the beginning, without exiting the input mode.

The [ESC] key is used to cancel the current entry, and exit the input mode.

The [ENT] key is used to save the input value - provided that it is valid - and exit the input mode.

Specifying the **SIZE**:

Pressing the [F1] key (INPUT) invokes the input mode.

Numeric keys [0] to [9] are used to enter a value of between 0 and 20000 for the size of the selected block (0 means that the block is inactive).

The total size of all 32 blocks must not exceed a value of 20000. The total size can be reduced at a later stage if the memory is not yet fully allocated (the number of allocated memory locations is displayed in parentheses).

The [BSP] key is used to delete the character entered last.

The [C] key is used to delete all the entered characters and repeat the input procedure from the beginning, without exiting the input mode.

The [ESC] key is used to cancel the current entry, and exit the input mode.

The [ENT] key is used to save the input value - provided that it is valid - and exit the input mode.

Selecting a **FILTER**:

The [→] and [←] cursor keys are used to set the following values:

ALL	:	Save all values.
GOOD	:	Only save good values (those within the comparator limits).
BAD	:	Only save bad values (those outside the comparator limits).
Xth VALUE	:	Save every Xth measured value.
hh:mm:ss	:	Save at the time interval specified in hours, minutes and seconds.
dR xx.xxx Ω	:	Save a value if its difference to the previous value exceeds dR.

Setting the X parameter:

Pressing the [F1] key (INPUT) invokes the input mode.

Numeric keys [0] to [9] are used to enter the required value.

Value range: 2 to 9999

The [BSP] key is used to delete the character entered last.

The [C] key is used to delete all the entered characters and repeat the input procedure from the beginning, without exiting the input mode.

The [ESC] key is used to cancel the current entry, and exit the input mode.

The [ENT] key is used to save the input value - provided that it is valid - and exit the input mode.

Setting the time interval:

Pressing the [F1] key (INPUT) invokes the input mode.

Numeric keys [0] to [9] are used to enter the required value.

Value range: 00:00:01 to 99:59:59

The [BSP] key is used to delete the character entered last.

The [C] key is used to delete all the entered characters and repeat the input procedure from the beginning, without exiting the input mode.

The [ENT] key is used to save the input value - provided that it is valid - and exit the input mode.

The [ESC] key is used to cancel the current entry, and exit the input mode.

The [F1] key (s), [F2] key (m) or [F3] key (h) is used to save the input value - provided that it is valid - and exit the input mode.

Specifying the dR parameter:

Pressing the [F1] key (INPUT) invokes the input mode.

The function keys are redefined in this case.



Numeric keys [0] to [9] and the [.] key are used to enter the dR value.
(5 digits plus the decimal point)

Value range: 0.01 mΩ to 200 kΩ

The [BSP] key is used to delete the character entered last.

The [C] key is used to delete all the entered characters and repeat the input procedure from the beginning, without exiting the input mode.

The [ESC] key is used to cancel the current entry, and exit the input mode.

The [F1] key (mOHM), [F2] key(OHM) or [F3] key(kOHM) is used to save the input value - provided that it is valid - and exit the input mode.

DELETE datalogger:

If this parameter is selected, the [F1] key (DEL1) and [F2] key (DEL2) are also activated.

The [→] and [←] cursor keys are used to set the following values:

ALL The entire datalogger is deleted.
 BLOCK The selected block is deleted.

Pressing the [F1] key (DEL1) and the [F2] key (DEL2) in turn deletes the datalogger or the selected block. The (DEL2) key serves for acknowledgement here.

5.4.4.3 Comparator setting menu

COMPARATOR		S 1	
COMPARATOR: OFF			
COUNT OF LIMITS : 2			
RELAYS:		ON	
ON ERROR:		NONE	
INPUT		HOME	RETU

Comparator-setting menu
page 1

The comparator is configured in this menu.

The following entries are possible:

[F3] key (HOME): This effects a return to the main menu.
 [F4] key (RETURN): This effects a return to the parameter selection menu or the comparator evaluation menu, depending on where the present menu was invoked from.

The [↑] and [↓] cursor keys are used to select the various parameters in the menu. The selected parameter is displayed inversely. Only the selected parameter can be changed.

The [POS1] key is used to select the 1st parameter in the window.
 The [END] key is used to select the last parameter in the window.

The [←] and [→] cursor keys are used to turn the **COMPARATOR** ON and OFF.

Note: When the comparator is on, the comparator evaluation

<< < = > >>

appears in the large measurement display, depending on the selected display menu (page 49).

If "OHM" has been selected, a small display of the evaluation appears in the error window.

The [←] and [→] cursor keys are used to set the **COUNT OF LIMITERS** to 2 or 4.

Note: This determines the number of selection stages.

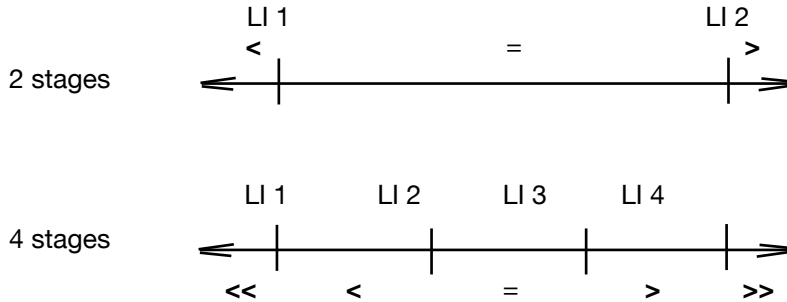

The [←] and [→] cursor keys are used to turn the **RELAY** ON and OFF.

Note: The PLC outputs should be used for rapid measurements, to prevent the relay contacts from being subjected to unnecessary wear.
 The relay contacts have a service life of approximately 10^9 switching operations in the no-load state, and approximately 10^6 switching operations at a load of 30 W.
 Irrespective of this setting, the PLC outputs are always active.

The [←] and [→] cursor keys are used to define the comparator's response

ON ERROR:

- NONE : No response in the event of an error
- > With 2 limiting values: The object under test is evaluated as being too large.
- >> With 4 limiting values: The object under test is evaluated as being too large.

The [▼] key is used to display page 2 of the list of parameters in the comparator menu.

Note: An error is indicated if the connections to the object under test are disrupted, a measurement line is interrupted, an incorrect measuring range has been set, or if any other reason prevents the object under test from being measured.

COMPARATOR			S 2
LLI : 12.34 OHM			
ULI : 125.67 OHM			
INPUT		HOME	RETU

Comparator
setting menu
page 2
(if 2 limiting values have been set)

COMPARATOR			S 2
LI 1 : 12.34 OHM			
LI 2 : 18.56 OHM			
LI 3 : 73.30 OHM			
LI 4 : 123.50 OHM			
INPUT		HOME	RETU

Comparator-
setting menu
page 2
(if 4 limiting values have been set)

The comparator limits can be specified here.

The following entries are possible:

- F3] key (HOME): This effects a return to the main menu.
- [F4] key (RETUrn): This effects a return to the parameter selection menu or the comparator evaluation menu, depending on where the present menu was invoked from.

The [↑] and [↓] cursor keys are used to select the various parameters in the menu. The selected parameter is displayed inversely. Only the selected parameter can be changed.

The [POS1] key is used to select the 1st parameter in the window.
The [END] key is used to select the last parameter in the window.

Pressing the [F1] key (INPUT) invokes the input mode.
The function keys are redefined in this case.

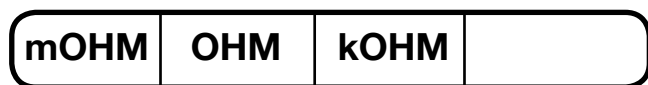

Numeric keys [0] to [9] and the decimal key [.] are used to modify the selected parameter value.

The [BSP] key is used to delete the character entered last.

The [C] key is used to delete all the entered characters and repeat the input procedure from the beginning, without exiting the input mode.

The [ESC] key is used to cancel the current entry, and exit the input mode.

Pressing the [F1] key (mOHM), [F2] key (OHM) or [F3] key (kOHM) completes the current entry. If valid, the entered value is saved and the input mode is exited.

Pressing the [▲] key invokes page 1 of the list of parameters in the comparator menu.
This does not apply if the present menu (comparator setting menu, page 2) has been invoked using the [F2] key (LIM).

5.4.4.4 Temperature compensation menu

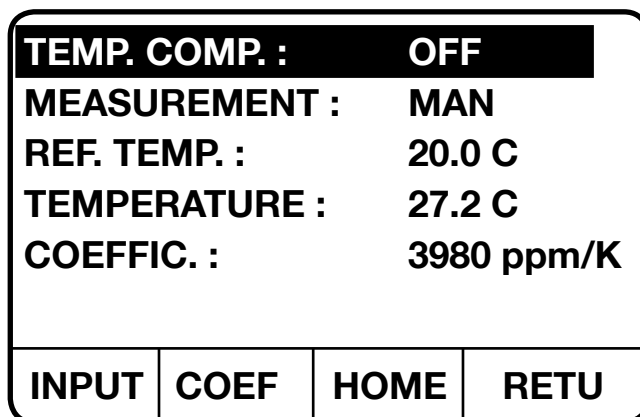

Display of the temperature compensation menu

The temperature compensation parameters are set in this menu.

The following entries are possible:

- F3] key (HOME): This effect a return to the main menu.
- [F4] key (RETUrn): This effects a return to the parameter selection menu or the comparator evaluation menu, depending on where the present menu was invoked from.

RESISTOMAT® Model 2329

The [↑] and [↓] cursor keys are used to select the various parameters in the menu. The selected parameter is displayed inversely. Only the selected parameter can be changed.
 The [POS1] key is used to select the 1st parameter in the window.
 The [END] key is used to select the last parameter in the window.

Activation/deactivation of **TEMP. COMP.**

The [→] and [←] cursor keys are used to set the following parameters:
 ON Temperature compensation is on.
 OFF Temperature compensation is off.

Activation of **MEASUREMENT**

The [→] and [←] cursor keys are used to set the following parameters:
 Pt100 Temperature recording with a Pt100
 U_IN Temperature recording via the voltage input
 I_IN Temperature recording via the current input
 MAN Manual entry of the temperature

Entry and display of the **TEMPERATURE**

During RECORDING with a Pt100 or a transmitter, the measured temperature is displayed here.
 During manual temperature compensation, the temperature is entered here manually.

Pressing the [F1] key (INPUT) invokes the input mode.

Numeric keys [0] to [9] and the [.] key are used to enter the temperature in ° C .
 The [BSP] is used to delete the character entered last.

The [C] key is used to delete all the entered characters and repeat the input procedure from the beginning, without exiting the input mode.
 The [ESC] key is used to cancel the current entry, and exit the input mode.
 The [ENT] key is used to save the input value - provided that it is valid - and exit the input mode.

COEFFicient

The selected temperature coefficient is displayed in ppm/K (parts per million/Kelvin).

Specifying the **REFERENCE TEMPERATURE**

Pressing the [F1] key (INPUT) invokes the input mode.
 Numeric keys [0] to [9] and the [.] key are used to enter the temperature in ° C .
 The [BSP] key is used to delete the character entered last.
 The [C] key is used to delete all the entered characters and repeat the input procedure from the beginning, without exiting the input mode.
 The [ESC] key is used to cancel the current entry, and exit the input mode.
 The [ENT] key is used to save the input value - provided that it is valid - and exit the input mode.

Note: The reference temperature is used to standardize the measured values. A temperature of 20 °C is recommended by the Association of German Electrical Engineers for this purpose. In other words, the temperature coefficient (TC) is used to convert the resistance of a test object at a temperature of x °C to a value corresponding to the reference temperature of 20 °C, and this value is then displayed. A reference temperature of 25 °C is also used in certain cases (e.g. by manufacturers in the USA).

TC 1 : 1600	TC 6 : 4030
TC 2 : 1700	TC 7 : 4500
TC 3 : 2400	TC 8 : 4800
TC 4 : 3100	TC 9 : 6000
TC 5 : 3930	TC10 : 6500
INPUT	HOME RETU

Display of the menu
for selecting the
temperature coefficient

The [↑] and [↓], [→] and [←] cursor keys are used to select the required coefficient. The selected coefficient is displayed inversely.

The [POS1] key is used to select TC1.

The [END] key is used to select TC10.

A selected coefficient can also be changed.

Pressing the [F1] key (INPUT) invokes the input mode.

Numeric keys [0] to [9] and the [.] key are used to enter a new coefficient in ppm/K.

The [BSP] key is used to delete the character entered last.

The [C] key is used to delete all the entered characters and repeat the input procedure from the beginning, without exiting the input mode.

The [ESC] key is used to cancel the current entry, and exit the input mode.

The [ENT] key is used to save the input value - provided that it is valid - and exit the input mode.

Note: The temperature coefficient (TC) indicates the rate at which the resistance of a material changes with the temperature:

e.g.	Copper	$3930 \text{ ppm}/_{\text{K}} \triangleq 0.393 \text{ } \%/_{\text{K}}$
	Brass 63	$1600 \text{ ppm}/_{\text{K}} \triangleq 0.160 \text{ } \%/_{\text{K}}$

The TC of metals and metal alloys is positive and approximately linear.

The [F4] key (RETUrn) saves the selected coefficient and effects a return to the temperature compensation menu.

The [F3] key (HOME) saves the selected coefficient and effects a return to the main menu.

5.4.4.5 Display menu

DISPLAY MENU			
DISPLAY :		d%	
SP. VAL :		134.56 mOHM	
INPUT		HOME	RETU

Display menu
(DISPLAY parameter has been selected)

The type of measurement display is selected in this menu.

The setpoint value needs to be entered for the d% (Delta%) display. The setpoint value is only indicated if d% has been selected.

The following entries are possible:

[F3] key (HOME): This effects a return to the main menu.

[F4] key (RETUrn): This effects a return to the parameter selection menu.

The [↑] and [↓] cursor keys are used to select the various parameters in the menu. The selected parameter is displayed inversely. Only the selected parameter can be changed.

The [POS1] key is used to select the 1st parameter in the window.

The [END] key is used to select the last parameter in the window.

Selecting the **DISPLAY**

The [←] and [→] cursor keys are used to select one of the following options:

OHM Measurement display in ohms
(When the comparator is on, the evaluation >>, >, =, <, << is displayed in the error window.)

d% Display of the measured value as Delta% of a setpoint value

EVALUATION When the comparator function is active, a large display can be selected for the evaluation (>>, >, =, <, <<).

Specifying a **SETPOINT VALUE**:

Pressing the [F1] key (INPUT) invokes the input mode, where a new value can be entered.

The [F] keys are redefined as follows:

DISPLAY MENU			
DISPLAY :		d%	
SP. VAL.:		134.56 mOHM	
mOHM	OHM	kOHM	

Display menu
(SETPOINT VALUE input has
been selected)

Numeric keys [0] to [9] and the [.] key are used to enter a new setpoint value.

The [BSP] key is used to delete the character entered last.

The [ESC] key is used to cancel the current entry, and exit the input mode. The original value is retained in this case.

The [C] key is used to delete all the entered characters and repeat the input procedure from the beginning, without exiting the input mode.

Pressing the [F1] key (mOHM), [F2] key (OHM) or [F3] key (kOHM) completes the entry, saves the new value if it is valid, and exits the input mode.

5.4.4.6 Interface menu

INTERFACE MENU			
INTERFACE:		IEEE488	
CONF		HOME	RETU

Selection of the interface

The following entries are possible:

[F3] key (HOME): This effects a return to the main menu.

[F4] key (RETUrn): This effects a return to the parameter selection menu.

The [←] and [→] cursor keys are used to select one of the following options:

IEEE 488 The RESISTOMAT® model 2329 can be operated via the IEEE488 interface, provided that an IEC-bus board has been installed (optional).

RS232 The RESISTOMAT® model 2329 can be operated via the RS232 interface.

The [F1] key (CONF) invokes the configuration menu for the currently selected interface.

IEEE488 Configuration menu

CONFIG. IEEE488			
ADDRESS :		9	
TRIGGER :		PASSIVE	
INPUT		HOME	RETU

Display of the IEEE488 configuration menu

The IEEE488 interface is configured in this menu.

The following entries are possible:

- [F1] key (INPUT): This effects a return to the input mode.
- [F3] key (HOME): This effects a return to the main menu.
- [F4] key (RETUrn): This effects a return to the interface selection menu.

The [↑] and [↓] cursor keys are used to select the various parameters in the menu. The selected parameter is displayed inversely. Only the selected parameter can be changed.

The [POS1] key is used to select the 1st parameter in the window.

The [END] key is used to select the last parameter in the window.

Setting the **ADDRESS**:

Pressing the [F1] key (INPUT) invokes the input mode.

Numeric keys [0] to [9] are used to enter a new address having a value of between 1 and 31.

The [BSP] key is used to delete the character entered last.

The [ESC] key is used to cancel the current entry, and exit the input mode. The original value is retained in this case.

The [C] key is used to delete all the entered characters and repeat the input procedure from the beginning, without exiting the input mode.

Pressing the [ENT] key completes the entry, saves the new value if it is valid, and exits the input mode.

Selecting a **TRIGGER** :

The [←] and [→] cursor keys are used to select one of the following options:

- ACTIVE
- PASSIVE

RS232 Configuration menu

CONFIG. RS 232			
FORMAT : 8DA 1PA 1ST			
BAUD RATE : 9600			
PARITY : ODD			
CHAR. DELAY: OFF			
		HOME	RETU

Display of the RS232 configuration menu

The RS232 interface is configured in this menu.

The following entries are possible:

- [F3] key (HOME): This effects a return to the main menu.
- [F4] key (RETUrn): This effects a return to the interface selection menu.

The [↑] and [↓] cursor keys are used to select the various parameters in the menu. The selected parameter is displayed inversely. Only the selected parameter can be changed.

The [POS1] key is used to select the 1st parameter in the window.

The [END] key is used to select the last parameter in the window.

Selecting a **FORMAT**:

The [←] and [→] cursor keys are used to select one of the following options:

- 8 DAta bits 0 PArity bits 1 STop bit
- 7 DAta bits 0 PArity bits 2 STop bit
- 7 DAta bits 1 PArity bits 1 STop bit
- 8 DAta bits 0 PArity bits 2 STop bit
- 8 DAta bits 1 PArity bits 1 STop bit

Setting the **BAUD RATE**:

The [←] and [→] cursor keys are used to select one of the following values:

- 38400
- 19200
- 9600
- 4800
- 2400
- 1200
- 600
- 300

Setting the **PARITY**:

The [←] and [→] cursor keys are used to select one of the following options:

- EVEN
- ODD

Setting the **CHARacter DELAY**:

The [←] and [→] cursor keys are used to select one of the following options:

- ON
- OFF

5.4.4.7 Device setting menu

STORE/LOAD CONFIG.			
STORE NUMBER: 12			
LOAD NUMBER: 8			
LABEL ST.: 1234567890			
LABEL LD: 0987654321			
INPUT	STOR	LOAD	HOME

Display for saving and loading device settings

Note

If the changeover is made by the PLC inputs, the datalogger block will be changed as well. If the changeover is made by the keypad, the datalogger block will not be changed.

The device settings can be saved and loaded from this menu.

The following entries are possible:

[F4] key (HOME): This effects a return to the main menu.

The [↑] and [↓] cursor keys are used to select the various parameters in the menu. The selected parameter is displayed inversely. Only the selected parameter can be changed.

The [POS1] key is used to select the 1st parameter in the window.

The [END] key is used to select the last parameter in the window.

STORE NUMBER. Here, you can enter a number between 0 and 31 under which the device setting is to be saved (the number can also be set with the [→] and [←] cursor keys).

Pressing the [F1] key (INPUT) invokes the input mode, where you can enter a new number.

Numeric keys [0] to [9] are used to enter a new value.

The [BSP] key is used to delete the character entered last.

The [ESC] key is used to cancel the current entry, and exit the input mode. The original value is retained in this case.

The [C] key is used to delete all the entered characters and repeat the input procedure from the beginning, without exiting the input mode.

Pressing the [ENT] key completes the entry, saves the new value if it is valid, and exits the input mode.

LOAD NUMBER. A number between 0 and 31 is entered here to load the corresponding device setting (the [→] and [←] cursor keys can also be used for this purpose). The default settings are stored under number 32 (which is labelled accordingly).

Pressing the [F1] key (INPUT) invokes the input mode, where a new number can be entered.

Numeric keys [0] to [9] are used to enter a new value.

RESISTOMAT® Model 2329

The [BSP] key is used to delete the character entered last.
The [ESC] key is used to cancel the current entry, and exit the input mode.
The original value is retained in this case.

The [C] key is used to delete all the entered characters and repeat the input procedure from the beginning, without exiting the input mode.

Pressing the [ENT] key completes the entry, saves the new value if it is valid, and exits the input mode.

LABEL ST. An ID assigned to SAVE NO. and having a maximum length of 10 characters is displayed here. This ID can be modified. Different SAVE NOS. cannot be assigned the same ID.

Pressing the [F1] key (INPUT) invokes the input mode.

Numeric keys [0] to [9] and the [.] key are used to enter a new ID.

The [BSP] key is used to delete the character entered last.

The [ESC] key is used to cancel the current entry, and exit the input mode. The original value is retained in this case.

The [C] key is used to delete all the entered characters and repeat the input procedure from the beginning, without exiting the input mode.

Pressing the [ENT] key completes the entry, saves the new value if it is valid, and exits the input mode.

LABEL LD. An ID assigned to LOAD NO. and having a maximum length of 10 characters is displayed here. This ID can be modified. Different LOAD NOS. cannot be assigned the same ID.

Pressing the [F1] key (INPUT) invokes the input mode.

Numeric keys [0] to [9] and the [.] key are used to enter a new ID.

The [BSP] key is used to delete the character entered last.

The [ESC] key is used to cancel the current entry, and exit the input mode. The original value is retained in this case.

The [C] key is used to delete all the entered characters and repeat the input procedure from the beginning, without exiting the input mode.

Pressing the [ENT] key completes the entry, saves the new value if it is valid, and exits the input mode.

Note: If a PC keyboard is used for input, alphanumeric values up to 10 characters long can be used as IDs for the various device settings.
If the device keypad is used for input, only numerical values can be entered as IDs.

Pressing the [F2] key (SAVE) saves the device setting currently selected under the number indicated by SAVE NO.

Pressing the [F3] key (LOAD) loads the device setting indicated by LOAD NO. and invokes the main menu.

5.4.4.8 Printer menu

PRINT:	OFF	TC:	OFF
NUM.:	ON	LAB.:	ON
DATE:	OFF	TIME:	OFF
MV/HEAD:	1000		
LABEL:	0123456789		
INTERVAL:	hh:mm:ss		
INPUT	RES	HOME	RETU

Display of the printer menu

The printing parameters are set in this menu.

The following entries are possible:

[F3] key (HOME): This effects a return to the main menu.

[F4] key (RETUrn): This effects a return to the parameter selection menu.

The [↑] and [↓] cursor keys are used to select the various parameters in the menu. The selected parameter is displayed inversely. Only the selected parameter can be changed.

The [POS1] key is used to select the 1st parameter in the window.

The [END] key is used to select the last parameter in the window.

Activating/deactivating the **PRINTING** function

The [→] and [←] cursor keys are used to set the following parameters:

ON The printing function is active.

OFF The printing function is inactive.

Activating/deactivating the **NUMERATOR**

The [→] and [←] cursor keys are used to set the following parameters:

ON The numerator is printed out.

OFF The numerator is not printed out

Activating/deactivating the **TC**

The [→] and [←] cursor keys are used to set the following parameters:

ON The temperature coefficient is printed out (if temperature compensation is active).

OFF The temperature coefficient is not printed out.

Activating/deactivating the **LABEL**

The [→] and [←] cursor keys are used to set the following parameters:

ON The LABEL is printed out.

OFF The LABEL is not printed out.

Activating/deactivating the **DATE**

The [→] and [←] cursor keys are used to set the following parameters:

ON The date is printed out.

OFF The date is not printed out.

RESISTOMAT® Model 2329

Activating/deactivating the **TIME**

The [→] and [←] cursor keys are used to set the following parameters:

ON The time is printed out.

OFF The time is not printed out.

Specifying the **MV/HEADer**

Pressing the [F1] key (INPUT) invokes the input mode.

Numeric keys [0] to [9] are used to specify the number of measured values after which a header is to be printed out.

The [BSP] key is used to delete the character entered last.

The [C] key is used to delete all the entered characters and repeat the input procedure from the beginning, without exiting the input mode.

The [ESC] key is used to cancel the current entry, and exit the input mode.

Pressing the [ENT] key saves the new value if it is valid, and exits the input mode.

Entering the **LABEL**

Pressing the [F1] key (INPUT) invokes the input mode.

Numeric keys [0] to [9] and the [.] key are used to enter an ID having a maximum length of 10 characters.

The [BSP] key is used to delete the character entered last.

The [C] key is used to delete all the entered characters and repeat the input procedure from the beginning, without exiting the input mode.

The [ESC] key is used to cancel the current entry, and exit the input mode.

Pressing the [ENT] key saves the new value if it is valid, and exits the input mode.

Specifying the time **INTERVAL** for the printout.

Pressing the [F1] key (INPUT) invokes the input mode.

Numeric keys [0] to [9] are used to enter the required values.

The [BSP] key is used to delete the character entered last.

The [C] key is used to delete all the entered characters and repeat the input procedure from the beginning, without exiting the input mode.

The [ESC] key is used to cancel the current entry, and exit the input mode.

Pressing the [ENT] key saves the new value if it is valid, and exits the input mode.

Pressing the [F2] key (RES) resets the numerator to 0.

5.4.4.9 Status selection menu

SEL. STATUS DISP.		S 1	
MEAS. RANGR:		ON	
MEAS. CURRENT/20mV :		OFF	
TEMP. / SP. VAL.:		ON	
		HOME	RETU

Display of the status selection menu (page 1)

SEL. STATUS DISP.		S 2	
SAMPLE SIGN:		ON	
SINGLE / CONT.:		OFF	
MAN. / AUTO:		ON	
LOAD:		OFF	
		HOME	RETU

Display of the status selection menu (page 2)

This menu is used to select the status messages to be displayed in the main menu. Except for error messages, all other status messages can be activated/deactivated here.

The following entries are possible:

[F3] key (HOME): This effects a return to the main menu.

[F4] key (RETURn): This effects a return to the parameter selection menu.

The [↑] and [↓] cursor keys are used to select the various parameters in this menu. The selected parameter is displayed inversely. Only the selected parameter can be changed.

The [POS1] key is used to select the 1st parameter in the window.

The [END] key is used to select the last parameter in the window.

The menu display consists of 2 pages.

The [▲] and [▼] keys are used to change from one page to the other.

Parameters on page 1:

Activating/deactivating the **MEAS**urement **RANGE** display

The [→] and [←] cursor keys are used to set the following parameters:

ON The measurement range is indicated.

OFF The measurement range is not indicated.

Activating/deactivating the **MEAS**urement **CURRENT / 20mV** display

The [→] and [←] cursor keys are used to set the following parameters:

ON The measurement current or 20mV is indicated.

OFF The measurement current or 20mV is not indicated.

Activating/deactivating the **TEMP. / SP. VAL.** display

The [→] and [←] cursor keys are used to set the following parameters:

ON The temperature or setpoint value is indicated.

OFF The temperature or setpoint value is not indicated.

Note: If the temperature compensation as well as the display of delta % are active, the temperature is indicated instead of the setpoint value.

Parameters on page 2:

Activating/deactivating the **SAMPLE SIGN** display

The [→] and [←] cursor keys are used to set the following parameters:

ON The sample signal is indicated.

OFF The sample signal is not indicated.

Activating/deactivating the **SINGLE**-frame / **CONT**inuous measurement display

The [→] and [←] cursor keys are used to set the following parameters:

ON Single-frame / continuous measurement is indicated.

OFF Single-frame / continuous measurement is not indicated.

Activating/deactivating the **MAN**ual / **AUTO**matic range display

The [→] and [←] cursor keys are used to set the following parameters:

ON Manual/automatic range selection is indicated.

OFF Manual/automatic range selection is not indicated.

Activating/deactivating the **LOAD** (R or Z) display

The [→] and [←] cursor keys are used to set the following parameters:

ON The measurement process (R or Z) is indicated.

OFF The measurement process (R or Z) is not indicated.

5.4.4.10 Additional PLC input/output bits

AUX. INPUT/OUTPUT			
BIT NUMBER:	3	2	1 0
INPUT:	1	0 0	1
OUTPUT:	1	1 0	
SET	RES	HOME	RETU

Display of the input/output menu

BIT NUMBER: Bit enumeration (0 to 3)

INPUT: The status of the spare inputs is indicated bitwise.

OUTPUT: The [→] and [←] cursor keys are used to select individual bits of the output. The selected bit is marked by a dash "-".

Pressing the [F1] key (SET) sets the selected bit.

Pressing the [F2] key (RESet) resets the selected bit.

Note: The set output bits **cannot** be stored as part of the device setting.

- [F3] key (HOME): This effects a return to the main menu.
- [F4] key (RETUrn): This effects a return to the parameter selection menu.

5.4.4.11 Scaling menu

SCALED INPUTS			
Pt100 INPUT			
VOLTAGE INPUT			
CURRENT INPUT			
SEL		HOME	RETU

Display of the scaling menu

The various inputs for temperature measurement are scaled in this menu. A Pt100 input for directly connecting a Pt100 sensor (e.g. type 2392-V001) is available in addition to a linear voltage/current input for connecting a temperature transmitter (e.g. pyrometer).

The following entries are possible:

- [F3] key (HOME): This effects a return to the main menu.
- [F4] key (RETUrn): This effects a return to the parameter menu.

The [↑] and [↓] cursor keys are used to select the various inputs. The selected parameter is displayed inversely.

The [POS1] key is used to select the 1st parameter in the window. The [END] key is used to select the last parameter in the window.

Pressing the [F 1] key (SEL) invokes the menu for scaling the selected input.

Scaling Pt100 input

Pt100 INPUT			
Rt = Ro * (1+A*t+B*t*t)			
Ro = 100			
A = 0.0039083			
B = -5.77e-07			
INPUT		HOME	RETU

Display of the menu for scaling the Pt100 input

This menu is used to enter the coefficients for the Pt100 curve in the range $\geq 100 \Omega$ (i.e. only positive temperatures).

- [F3] key (HOME): This effects a return to the main menu.
- [F4] key (RETUrn): This effects a return to the scaling main menu.

The [↑] and [↓] cursor keys are used to select the various coefficients. The selected parameter is displayed inversely.

The [POS1] key is used to select the 1st parameter in the window.
The [END] key is used to select the last parameter in the window.

The required coefficient can now be entered:
Pressing the [F1] key (INPUT) invokes the input mode.

Numeric keys [0] to [9] , the decimal key [.] and the sign key are used to enter the coefficient.

The [BSP] key is used to delete the character entered last.

The [C] key is used to delete all the entered characters and repeat the input procedure from the beginning, without exiting the input mode.

The [ESC] key is used to cancel the current entry, and exit the input mode.

Pressing the [ENT] key saves the new value if it is valid, and exits the input mode.

Note: The coefficients entered by the manufacturer comply with DIN EN 60751 for positive temperatures.
The C coefficient cannot be entered (only positive temperatures).
DIN EN 60751 values are always used for negative temperatures (< 100 Ω).

Scaling the current input

CURRENT INPUT			
I1	=	2 mA	
t1	=	20 °C	
I2	=	20 mA	
t2	=	100 °C	
INPUT		HOME	RETU

Display of the menu for scaling the current input

The (linear) current input is scaled in this menu.

Example: A temperature sensor indicates an output current of 2 mA at 20 °C and 20 mA at 100 °C.
The input current can have a value ranging from 0 ... 20 mA .

[F3] key (HOME): This effects a return to the main menu.
[F4] key (RETUrn): This effects a return to the scaling menu.

The [↑] and [↓] cursor keys are used to select the various parameters. The selected parameter is displayed inversely.

The [POS1] key is used to select the 1st parameter in the window.
The [END] key is used to select the last parameter in the window.

The required parameters can now be entered.
Pressing the [F1] key (INPUT) invokes the input mode.

Numeric keys [0] to [9] and the decimal key [.] are used to enter the parameters.
The [BSP] key is used to delete the character entered last.

The [C] key is used to delete all the entered characters and repeat the input procedure from the beginning, without exiting the input mode.

The [ESC] key is used to cancel the current entry, and exit the input mode.

Pressing the [ENT] key saves the new value if it is valid, and exits the input mode.
I1 and I2 or t1 and t2 must not be identical.

Scaling the voltage input

VOLTAGE INPUT			
U1	=	1 V	
t1	=	25 °C	
U2	=	9 V	
t2	=	450 °C	
INPUT		HOME	RETU

Display of the menu
for scaling the voltage input

The (linear) voltage input is scaled in this menu.

Example: A temperature sensor indicates an output voltage of 1 V at 25 °C and 9 V at 450 °C.
The value of the input voltage can range from 0 ... 10 V.

[F3] key (HOME): This effects a return to the main menu.

[F4] key (RETUrn): This effects a return to the scaling menu.

The [↑] and [↓] cursor keys are used to select the various parameters. The selected parameter is displayed inversely.

The [POS1] key is used to select the 1st parameter in the window.

The [END] key is used to select the last parameter in the window.

The required parameters can now be entered.
Pressing the [F1] key (INPUT) invokes the input mode.

Numeric keys [0] to [9] and the decimal key [.] are used to enter the parameters.
The [BSP] key is used to delete the character entered last.

The [C] key is used to delete all the entered characters and repeat the input procedure from the beginning, without exiting the input mode.

The [ESC] key is used to cancel the current entry, and exit the input mode.

Pressing the [ENT] key saves the new value if it is valid, and exits the input mode.
U1 and U2 or t1 and t2 must not be identical.

5.4.4.12 Setting the contrast

LCD CONTRAST			
CONTRAST : 5			
INPUT		HOME	RETU

Display of the menu for adjust the contrast

Pressing the [F1] key (INPUT) invokes the input mode.

Numeric keys [0] to [9] are used to adjust the contrast between 0 and 10.

The [BSP] key is used to delete the character entered last.

The [C] key is used to delete all the entered characters and repeat the input procedure from the beginning, without exiting the input mode.

The [ESC] key is used to cancel the current entry, and exit the input mode.

Pressing the [ENT] key saves the new value if it is valid, and exits the input mode.

The contrast can also be adjusted with the [→] and [←] cursor keys.

[F3] key (HOME): This effects a return to the main menu.

[F4] key (RETUrn): This effects a return to the parameter selection menu.

Note: Changes to the contrast setting correspondingly change the ideal viewing angle.

5.4.4.13 Calibration menu

CALIBRATE MEAS. RANGES			
200 mOHM		2 KOHM	
2	OHM	20	KOHM
20	OHM	200	KOHM
200	OHM		
SEL		HOME	RETU

Selection of a measurement range for calibration (figure 13-1)

This menu is used to select a measurement range for calibration.

The [↑], [↓], [→] and [←] cursor keys are used to select the various menu parameters. The selected parameter is displayed inversely.

The [POS1] key selects the 1st parameter in a column.
 The [END] key selects the last parameter in a column.

[F3] key (HOME): This effects a return to the main menu.
 [F4] key (RETUrn): This effects a return to the parameter selection menu.

Pressing the [F1] key [SEL] acknowledges the inversely displayed measurement range for calibration. The following display appears on the LCD:

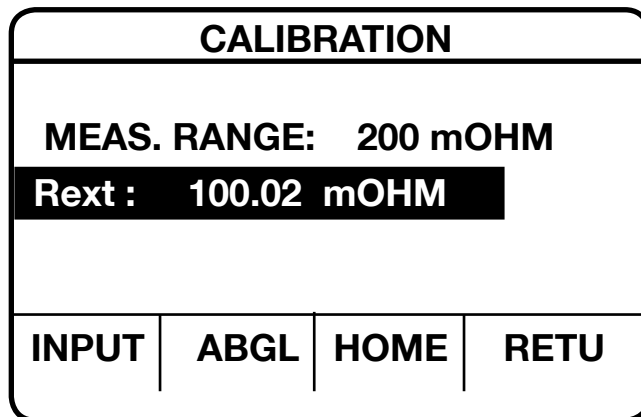

Acknowledgement of a measurement range for calibration
 (figure 13-2)

[F3] key (HOME): This effects a return to the main menu.

[F4] key (RETUrn): This effects a return to the menu titled CALIBRATE MEAS. RANGES (figure 13-1).

Pressing the F1 key [INPUT] invokes the input mode, where the value of the externally connected calibration resistance can be entered.

In this case, the function keys are redefined as follows:



Display during the input of actual values
 (figure 13-3)

Numeric keys [0] to [9] and the decimal [.] key are used to specify the value of the externally connected calibration resistance.

The [BSP] key is used to delete the character entered last.

The [C] key is used to delete all the entered characters and repeat the input procedure from the beginning, without exiting the input mode.

The [ESC] key is used to cancel the current entry, and exit the input mode.

The [F1] key [mOHM], [F2] key [OHM] or [F3] key [kOHM] is used to save the input value - provided that it is valid - and exit the input mode.

Pressing the F2 [BAL] key subsequently causes the selected resistance range to be calibrated.

The following display appears on the LCD:

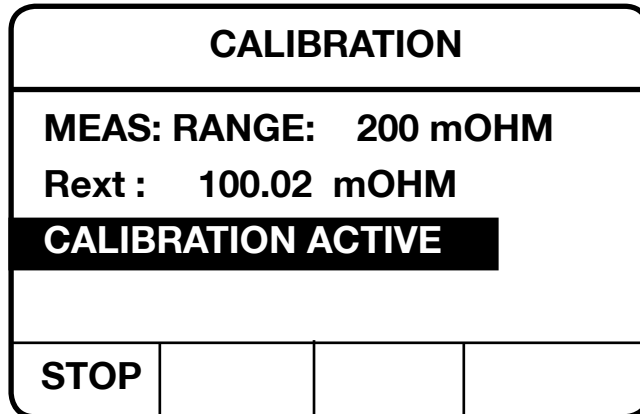

Display while calibration is in progress (figure 13-4)

Once calibration has been performed successfully, the program returns to the menu titled CALIBRATE MEAS. RANGES (figure 13-1).

If an error occurs during calibration or this process is interrupted with the F1 key [STOP], a corresponding warning/error message is issued and the program returns to the menu displayed in figure 13-2.

Note: This menu can be used for digital calibration of the individual measurement ranges. The values of the reference resistances should lie in the middle of the respective measurement ranges. For this purpose, we recommend using the calibration resistances of the 1240 series with a DKD/DAkkS certificate (Deutscher Kalibrierdienst).

If the device is re-calibrated in any measurement range by a user, the corresponding calibration performed by the manufacturer is overwritten. For this reason, all changes made by the user should be carefully documented. The reading of the CAL counter (page 25) should be noted here.

Calibration instruments and their uncertainty factors:

Measuring range	100 mΩ	40 ppm
Measuring range	1 Ω	40 ppm
Measuring range	10 Ω	40 ppm
Measuring range	100 Ω	40 ppm
Measuring range	1 kΩ	40 ppm
Measuring range	10 kΩ	40 ppm
Measuring range	100 kΩ	40 ppm

NOTICE	
!	<p>The housings of measuring resistors having values $\geq 1 \text{ k}\Omega$ must remain connected to the ground terminal of the RESISTOMAT® model 2329 while measurements are in progress. If not, the measurement results might be corrupted by interference from 50-Hz fields.</p> <p>If the entire RESISTOMAT® model 2329 needs to be calibrated, including the Pt100 input, 0-10 V / 0-20 mA input, 20 mV operating mode etc., the RESISTOMAT® model 2329 should be sent back to the manufacturer because additional calibration equipment is required in this case.</p>

5.4.4.14 Change Codes

In this menu the preselected codes for the access menu (2609) and the device default setting (9062) can be changed.

CHANGE CODES			
ACCESS CODE		XXXX	
RESET CODE		XXXX	
ENTER OLD CODE			
INPU		HOME	RETU

The following entries are permissible:

The [↑] and [↓] cursor keys are used to select the required code (access or reset).

The [F3] key [INPUt] is used to entry the 4 digit code.

The [F3] key [HOME] effects a return to the main menu.

The [F4] key (RETUrn) effects a return to the parameter selection menu.

CHANGE CODES			
ACCESS CODE		XXXX	
RESET NEW		1.+++	
CODE OK			
ENTER NEW CODE			
			RETU

During entry the new code the sign X changes into +. After the entry of the fourth digit appears immediately the message to repeat the entry (confirm the new code).

CHANGE CODES			
ACCESS CODE		XXXX	
RESET NEW		2.+++	
CODE OK			
REPEAT INPUT			
			RETU

6. Remote Control of the Device

6.1 General information

The RESISTOMAT® model 2329 is equipped with a PLC and RS232-C interface as standard features. Optionally, the RESISTOMAT® model 2329 can also be fitted with an IEEE488 interface. The selection of the required interface and its parametrization are described in chapter 5.4.4.6 titled "Interface menu".

6.1.1 Terminal assignment of the RS232 interface

The 9 pole Submin-D socket is assigned as following

With an RS232 interface:

RESISTOMAT® model 2329		Computer 9 connector
Pin		Pin
2	TXD	2 RXD
3	RXD	3 TXD
8	-	.8 CTS
7	Connected in the device	7 RTS
4		4 DTR
6	-	6 DSR
5	GND	5 GND

Note: In the case of Basic programs, DTR, DSR and CTS must be bridged on the PC side. This is achieved automatically by the internal bridges of the device if a 9-pole 1:1 type 9900-K333 cable is used.

6.1.2 Control via the RS232 interface

To allow control of the RESISTOMAT® model 2329 via the RS232 interface, all the RS232 parameters in the interface menu (chapter 5.4.4.6) must be set.

Protocol

The following ANSI standard transmission protocol is used by the serial interface of the RESISTOMAT® model 2329:

ANSI X3.28-1976 Subcategory 2.1, A3

Command without query form

- The device waits for a command having the form: <STX>Command1<LF><ETX>
 - <STX>: ASCII value 02
 - Command1: SCPI command without query form
 - <LF>: ASCII value 10
 - <ETX>: ASCII value 03

2. On the reception of a valid command, the device responds with <ACK>. On the reception of an invalid command, the device responds with <NAK>.

<ACK>:	ASCII value 06
<NAK>:	ASCII value 21

Command with query form

1. The device waits for a command having the form : <STX>Command2<LF><ETX>

<STX>:	ASCII value 02
Command2:	SCPI command with query form
<LF>:	ASCII value 10
<ETX>:	ASCII value 03
2. On the reception of a valid command, the device responds with <ACK>. On the reception of an invalid command, the device responds with <NAK>.

<ACK>:	ASCII value 06
<NAK>:	ASCII value 21
3. To fetch the requested data, an <EOT> must be sent to the device.

<EOT>:	ASCII value 04
--------	----------------
4. The device then supplies the data in the following form:

<STX>Data<CR><LF><ETX>	
<CR>:	ASCII value 13
5. The reception of the data must be acknowledged with <ACK>.
6. Items 4 and 5 are repeated until no data are present any more. The device then responds with <EOT>. After that, the device assumes its initial state and is ready ready to receive a new command.

Timer functions

Timer A (response timer)

Timer A is used by the transmitting station as a safeguard against no response or an invalid one.

Start: Timer A is started once data transmission has been completed with ETX as described previously under item 4.

Stop: Timer A is stopped once a valid response has been received <ACK>.

Timeout: When a timeout occurs, the RESISTOMAT® 2329 sends an <EOT> and assumes its initial state (ready for a new command).

The timeout value of timer A is set firmly to 15 seconds.

Timer B (receive timer)

Timer B is used by the receiving station as protection against failure to identify an <ETX> signal.

Start: Timer B is started on the reception of the <STX> signal as described previously under item 1.

Restart: Timer B is restarted during data transfer to allow the reception of data blocks of variable lengths.

Stop: Timer B is stopped on the reception of the <ETX> signal.

Timeout: When a timeout occurs, the received data (command) are discarded. The device then assumes its initial state and is ready to receive a new command.

The timeout value of timer B is set firmly to 15 seconds.

6.1.3 Terminal assignment of the optional IEEE488 interface

The 24-pole IEEE488 bus connection plug is standardized and has the indicated pin assignment.

To comply with applicable interference protection guidelines (e.g. VDE 0871B), all interface cables and plugs must be shielded and grounded at both ends.

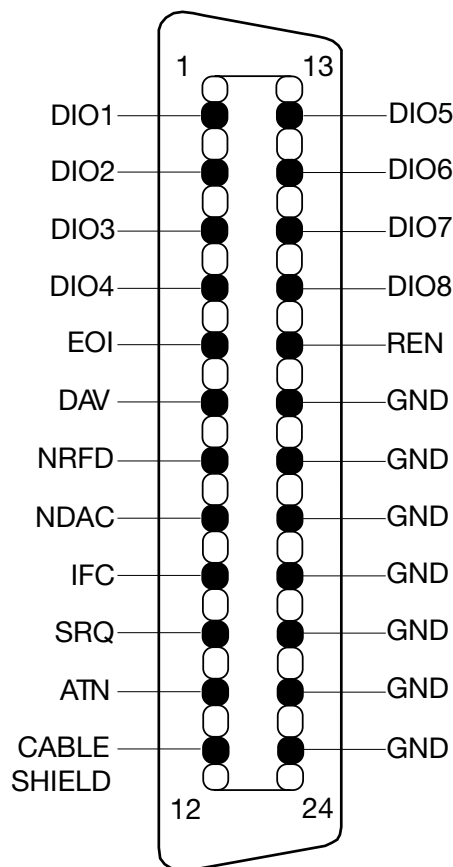

These are "Open Collector" outputs.

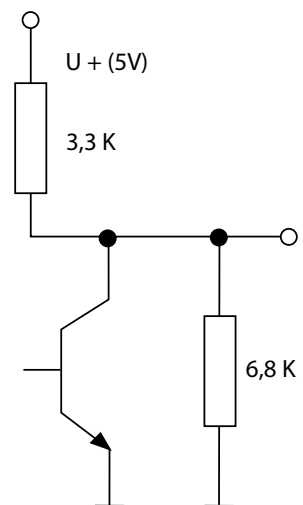

6.1.4 Control via the optional IEEE488 interface of the RESISTOMAT® 2329

For the device to be controlled via the IEEE488 interface, the IEEE488 option must be selected in the interface menu (chapter 5.4.4.6). However, this is only possible if the IEEE488 card has been installed.

Setting the device address

The device address of the RESISTOMAT® model 2329 for control via the IEEE488 is set in the corresponding interface menu. A number in the range 0...30 can be selected for the address. The default setting 9 is used in all the examples here. Every device connected to the IEEE488 must have its own address. If the address of a device is changed on the front panel, the new address becomes effective immediately.

Input/output commands

For control of the 2329 by an IEEE488 controller, the corresponding input/output commands must be known. The command syntax is provided in the operating manual of the IEEE488 controller. The following input/output commands are used in the Basic language of the HP series 200/300:

OUTPUT and ENTER.

If a National-PC card has been installed, the commands are:

IBWRT and IBRD.

The examples in this manual are written in Q Basic.

Sending a command

Commands sent to the 2329 must comply with the SCPI format. For example, the following command is sent to adjust the display contrast:

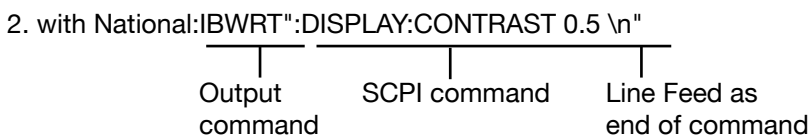
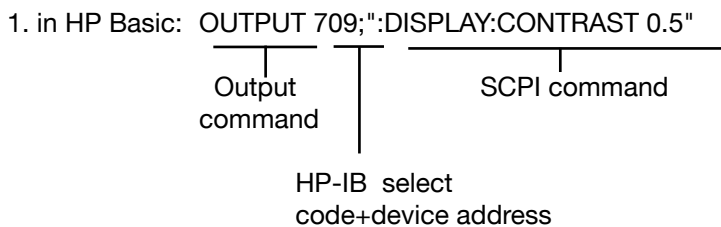

Reception of data from the 2329

The 2329 sends data requested via an SCPI query command. For example, on receiving the following query:

`OUTPUT709;":DISP:CONT?"`

the 2329 writes the current setting of the display contrast to its output buffer. This response can be fetched with the input command of the IEEE488 controller.

Remote/local

On receiving a command addressed to it, the 2329 switches into the remote state. In this state, function key F4 is designated LOCAL, and except for this key, all other keys are disabled.

A switchover to the local mode can be performed by pressing the local key or sending a Go-to-local command via the IEEE488.1.

If a LocalLockout command was sent via the IEEE488.1, the 2329 can only be switched to the local mode using the Go-to-local command, because the local key is also disabled in this case. This corresponds to the command SYSTem:CLOCK ON (e.g. with an RS232 interface).

6.1.5 Terminal assignment of the PLC interface

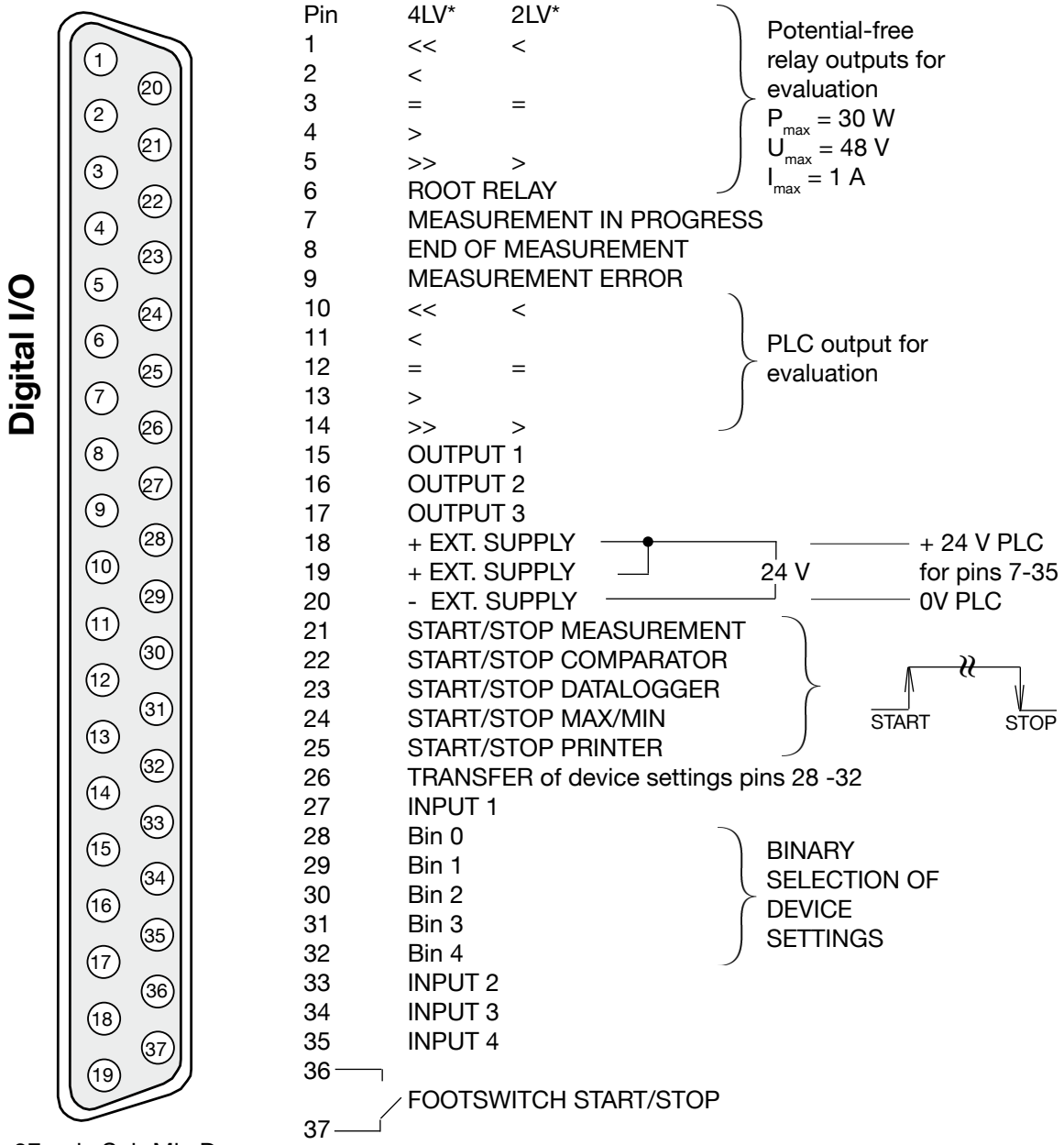

37 pole Sub Min D
View of socket

*LV = Limit value

Plug housing: Potential PE
Mating connector: Type 9900-V165

PLC input (schematic)

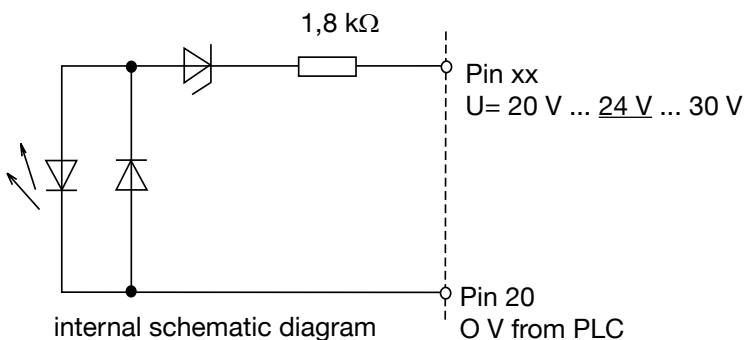

PLC output (schematic)

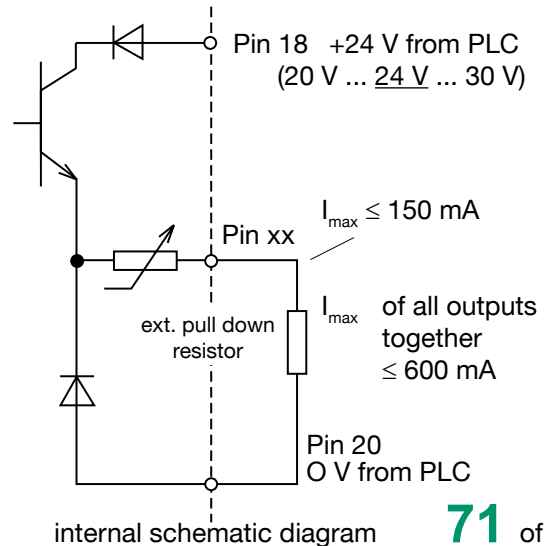

6.1.6 Control via the PLC interface

The PLC interface of the RESISTOMAT® 2329 was developed in accordance with the DIN EN 61131-2 standard. The circuitry is designed for a feed voltage of 24 V DC -15 % / +20 %. The PLC outputs of the 2329 were developed for current-consuming PLC inputs. The 2329 has current-consuming PLC inputs.

The logic system is positive. The low level is -3 V to +5 V, the high level is +15 V to +30 V.

If high-impedance inputs are connected to the PLC outputs of the 2329, a resistor might need to be connected to ground to prevent the output leakage current (Low < 0,2 mA) from giving rise to undesirable high levels. Be careful that the leakage current at the ext. pull down resistor gives a voltage less than 5 V because only a voltage up to 5 V is for the PLC "Low".

A prerequisite for use of the PLC interface is the connection of an external DC power supply to the 37 pole D-Sub socket ("+" to 18 or 19 and "-" to 20). The PLC interface is isolated from all internal circuit components by means of optocouplers. The voltage between protective earth (PE) and "-" must not exceed 30 V.

Available inputs:

- | Start / stop measurement
- | Start / stop (reset) comparator
- | Start / stop datalogger
- | Start / stop max. / min.
- | Start / stop printer
- | Transfer of device settings
- | 5 inputs for binary selection of the device settings (e.g. input 0 = 2⁰)
- | 4 inputs which can be read out via the interface (only with the measurement stopped).

Available outputs:

- | End of measurement
- | Previous measurement faulty
- | Measurement in progress
- | Output for evaluation (comparator) >> or > with 2 limiting values
- | Output for evaluation (comparator) >
- | Output for evaluation (comparator) =
- | Output for evaluation (comparator) <
- | Output for evaluation (comparator) << or < with 2 limiting values
- | 3 outputs which can be controlled via the interface (only with the measurement stopped).

The device is also equipped with 2 terminals for starting and stopping measurements, as well as 5 relay contacts (NO) with a common root on this socket.

Measurements can be triggered by closing a simple mechanical contact (e.g. footswitch). This contact should have a low bounce factor. Renewed closure (after opening) stops the measurement or, in the case of a single measurement, starts one again after the measurement time has elapsed.

The relays allow easy evaluation with the comparator function if only a few measurements need to be performed. Caution: In the continuous mode, proper operation of the relays cannot be guaranteed beyond the specified number of cycles. If many measurements need to be performed, the PLC evaluation output **must** be used.

If PLC-control is involved, manual range selection and single measurements are usually necessary, as only this can ensure reliable operation. This is because if an error occurs in the automatic range selection mode, other measuring ranges need to be checked before the cause of the error can be determined. In such cases, the time-pulse of the system can often be exceeded (measuring time = (number of measuring ranges to be checked) * single measurement time).

In the continuous measurement mode, the results obtained with an active comparator or datalogger cannot be assigned to an individual test object, thus leading to diffuse statistics.

	<h2>NOTICE</h2>
	<p>Before commencing a measurement, ensure that proper bonding has taken place. The measurement starts just a few microseconds after reception of the command.</p>

Function of the PLC interface:

When the device is turned on, all output levels are low.

All functions are activated by a rising edge (low - high) and deactivated by a falling edge (high - low). Deactivating a function already in progress causes it to be terminated immediately.

The outputs are static; they retain their state until another state is introduced.

The outputs are set as quickly as possible following the occurrence and identification of an event.

For an evaluation of the outputs, the end-of-measurement line needs to be monitored. A rising edge at this output indicates that the remaining outputs are now valid.

After power-on, the end-of-measurement output is low just like all the other outputs.

After a measurement result or error has been identified internally, the outputs are set and the end-of-measurement line is set to a high level roughly 1 ms later. This indicates to the connected PLC that the other outputs have valid states which can be transferred and read.

Roughly 0.1 ms - 0.3 ms after the resumption of a single measurement, the end-of-measurement line is reset to a low level. In the case of continuous measurements, this takes place after a few milliseconds (the precise time depends on the configuration and the test object).

A rising edge at the end-of-measurement line indicates that the outputs are now valid.

This applies to evaluations and measurement errors.

“Measurement in progress” is set to high roughly 0.1 ms - 0.3 ms following commencement of the measurement. In the case of single measurements, the line is set to low roughly 0.2 ms after the rising edge of the end-of-measurement signal. In the case of continuous measurements, this takes place roughly 0.2 ms after the end of measurement.

Following transmission through an interface, the outputs which are controlled via this interface require about 0.1 s to change levels (this is only possible in the stopped state).

Inputs can be read out roughly 0.1 seconds after the occurrence of an event, if interfaces are being used exclusively to read these inputs (this is only possible in the stopped state).

Example of control via a PLC:

Configuration of the device via a keypad or an interface (e.g. single measurement, manual angle selection, entry of limiting values, selection of temperature compensation, disabling of keyboard operation etc.), **or** loading of a device configuration by applying the binary address to the 5 inputs (28 - 32). After a waiting period of roughly 5 ms, the selected setting is transferred by a rising edge (low - high) at the transfer input (26). After that, the line is reset to low and a waiting period of roughly 10 ms elapses until the settings have been transferred.

The comparator, datalogger or any other required function is set by applying a high level to the corresponding input **in case of a deviation from the invoked setting** (low - high edge for activation, high - low edge for deactivation).

Scanning if MEASUREMENT IN PROGRESS (7) is low. If yes, then start, else stop and check beforehand.

Triggering of the measurement by a low - high edge at the Start/Stop measurement input (21).

Important: A high - low edge stops (aborts) the measurement.

Scanning the end-of-measurement line (8) for a positive edge (low - high). This must take place within a certain time period (depending on the configuration, measuring range and test object), otherwise the setup needs to be examined.

NOTICE

Following the start command, this line needs to be scanned for the edge.

Reasons:

From the second start following activation of the device, the end-of-measurement level remains high for roughly 0.1 ms - 0.3 ms. After that, the line is set to low until an error is detected or a measurement result is available. This low period can vary, depending on the type of the error and the configuration (automatic range selection, average-value formation, R / Z, conversion, measurement procedure, temperature recording etc.). It can range from a few milliseconds to several seconds, but is rarely longer than the standard measuring time, except if automatic range selection is active

Following identification of a positive edge, the start line is reset to low and the evaluation/error lines are read in. If a measurement error has occurred, it was not possible to measure the test object (incorrect bonding, measuring range, temperature recording etc.). Otherwise evaluation is performed and the measurement procedure is resumed for the next test object.

Timing of the PLC interface

Settings: Manual 200 mΩ, display 20000, comparator 2 limiting values, on error >, R, average = 1, standard conversion, standard measurement procedure, single measurement

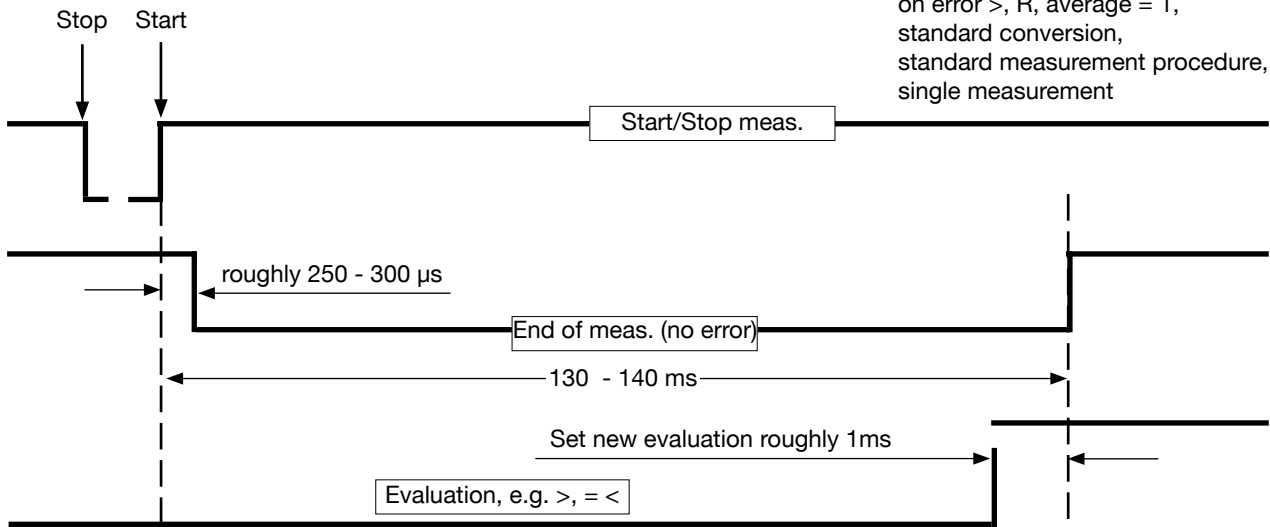

Deviations in timing in the event of an error

Different errors are detected at different times and output as quickly as possible. Excessively large measurement values can only be identified at the end (given a slight transgression of the measuring range), or when the measuring current is turned on (given an excessively low driving current for the connected resistor) or during a cable-breakage test.

Low overdrive: (e.g. 208 mΩ in the 200 mΩ range)

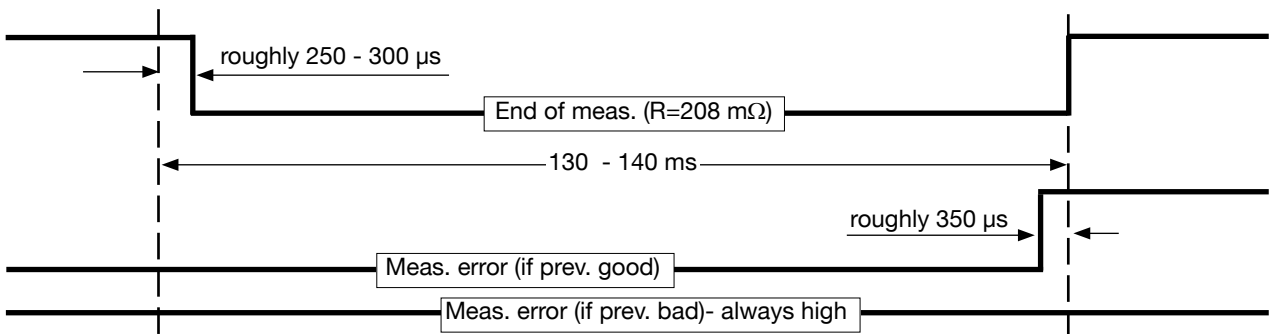

Medium overdrive: (e.g. 300 mΩ in the 200 mΩ range)

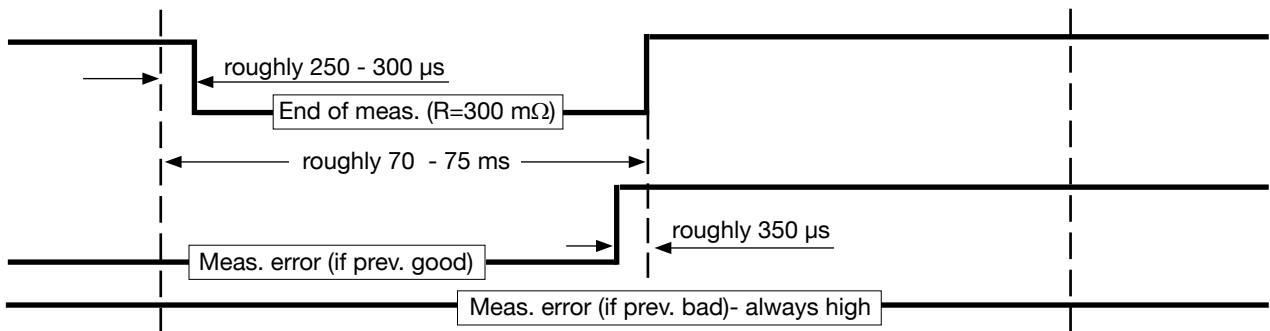

Important:

A falling edge at 'Start/Stop measurement' stops the single or continuous measurement in progress.

Timing of the PLC interface

Settings: Manual 200 mΩ, display 20000, comparator 2 limiting values, on error >, R, average value = 1, standard conversion, standard measurement procedure, single measurement

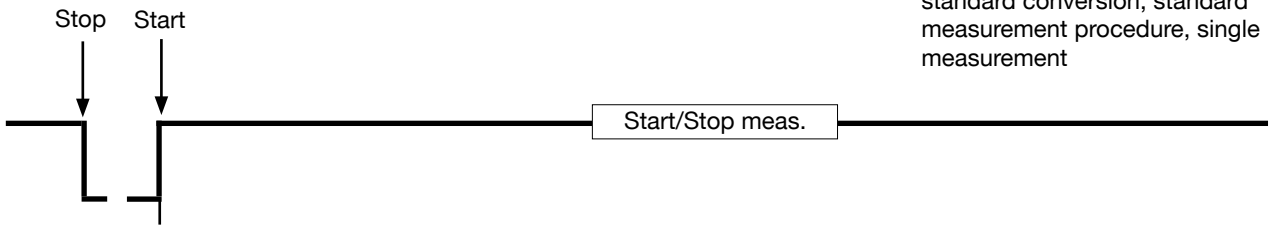

High overage: (e.g. 1 MΩ in the 200 mΩ range or test object interrupted)

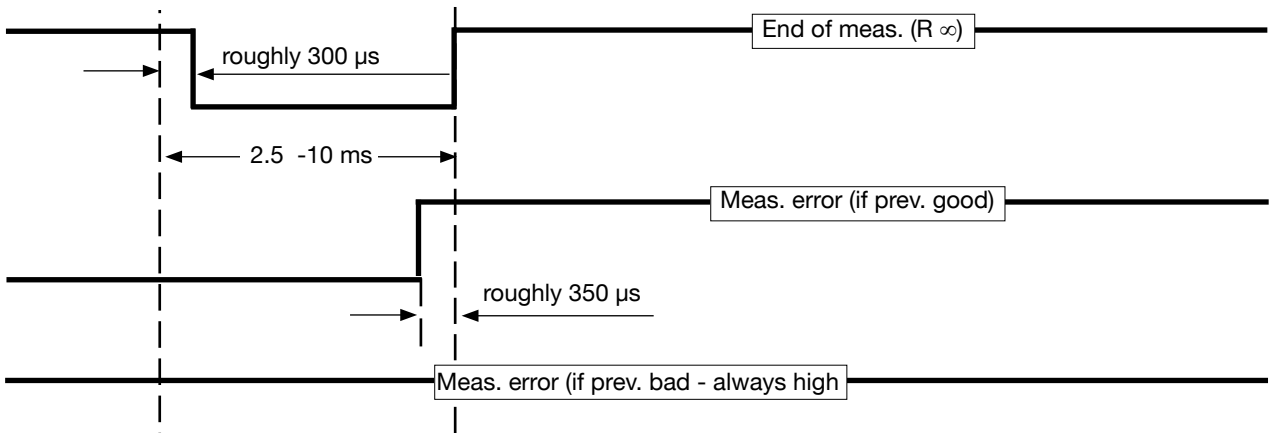

Test object is measurable after measurement error:

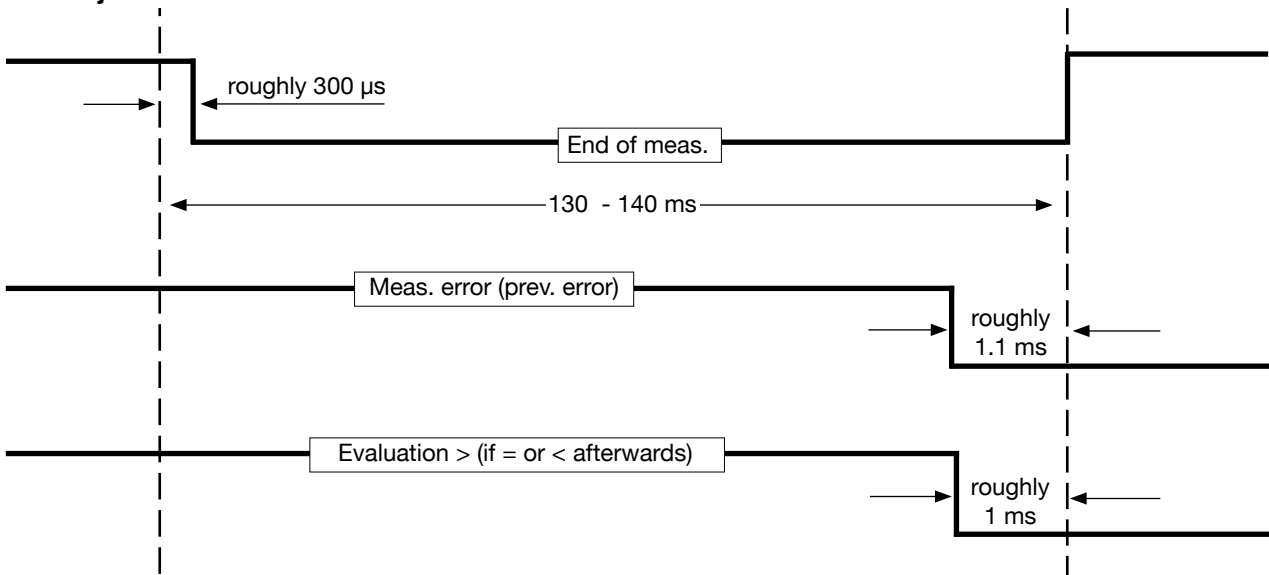

Roughly 300 μs following the application of a positive edge to "Start/stop measurement", the measurement is commenced internally. By then, proper bonding must have been ensured. Immediately after starting, the end-of-measurement output should be scanned for a positive edge (or at least for a positive level 1 ms later). Following identification, the measurement error and evaluation must be read in. Different values (usually smaller ones) apply to other measuring ranges ($\geq 20 \Omega$) and other settings.

6.2 RESISTOMAT® command language

6.2.1 Introduction

The command language of the 2329 is called **SCPI (Standard Commands for Programmable Instruments)**. SCPI is a universal language with standardized commands agreed by the leading manufacturers of electrical equipment. SCPI not only provides a standardized set of commands but also allows manufacturers to define their own commands in accordance with specific rules.

In addition to these commands, all SCPI devices should implement the following **IEEE488.2 common commands**:

- *CLS Clear Status Command
- *ESE Standard Event Status Enable Command
- *ESE? Standard Event Status Enable Query
- *ESR? Standard Event Status Register Query
- *IDN? Identification Query
- *OPC Operation Complete Command
- *OPC? Operation Complete Query
- *RST Reset Command
- *SRE Service Request Enable Command
- *SRE? Service Request Enable Query
- *STB? Read Status Byte Query
- *TST? Self-Test Query
- *WAI Wait to Continue Command

6.2.2 Befehlskopf

e.g. **DISPlay**

Every SCPI command header has a long and a short form, and every SCPI device should just accept precisely this long and short form. The IEEE488.2 limits the length of a command header to 12 characters.

The long form either comprises one single word or abbreviations of several words. The short form is an abbreviation of the long form.

If a command consists of a single word, this word is the long form of the command (e.g. DISPLAY). If a command consists of several words, it is formed from the first letters of each word and the entire last word. For example, the words 'line frequency' are shortened to the command 'LFREQUENCY'.

The short form of the command header normally comprises the first four letters of the long form (e.g. DISP). An exception is when the long form consists of more than four letters, the fourth one being a vowel. In this case, the vowel is left out. The short form then only contains the first three letters of the long form. For example, the short form of the calibration command is CAL.

The command list shows commands in their long form, with the short form in upper case and the remainder of the command in lower case.

Commands can be transmitted in lower and upper case.

6.2.3 Command tree

The SCPI command tree has a hierarchical structure. This allows the same command header to be used for several different functions on different levels of the hierarchy.

e.g.



The different command levels are separated by a ":". Some commands have optional headers. For example, the command INITiate:IMMEDIATE has an optional header "IMMEDIATE" on level 2. Optional headers need not be transmitted with their related commands.

The command list shows optional command sections enclosed in square brackets, e.g. INITiate[:IMMEDIATE]. The brackets are not part of the command, and must not be transmitted with it.

6.2.4 Query form

All commands have a related query form, if not specified otherwise. As defined in IEEE488.2, the query form of a command is created by appending a question mark to the command header (e.g. DISPlay:CONTRast?). A query form can, but need not, be sent with a parameter. When the 2329 receives the query form of a command, the current setting related to the command is written to the output buffer. The response to a query command does not contain the command header. If the response to a query command consists of one word, the short form is always used.

6.2.5 Navigating the command tree

A command message to the 2329 can comprise several commands. The first command always refers to the root directory. A subsequent command always refers to the same tree level as the previous command. The individual commands in a command message are separated by a semicolon. Commands sent with a leading colon always refer to the root directory. Command messages are concluded with a "Line Feed" (<nl>).

Example: If a device has the following command tree:

```
INITiate      :CONTInuous <parameter>
                [:IMMEDIATE]
```

ABORT

then the following command messages have the described effect:

```
INIT:CONT ON;IMM<nl>
```

switches the device to continuous measurement and starts the measurement.

```
INIT:CONT ON;;INIT:IMM<nl>
```

switches the device to continuous measurement and starts the measurement.

```
INIT:IMM;ABOR<nl>
```

starts the measurement and generates an error, because ABOR is not a command on the current interpreter level.

```
INIT:CONT ON;;INIT;;ABOR<nl>
```

switches the device to continuous measurement, starts the measurement and stops it again.

6.2.6 Parameter

The valid parameters for each command, together with the related syntax, are described in the following chapter. The parameters are separated from the command by a blank character.

Format of a resistance parameter:

A parameter which sets a resistance value or resistance measuring range can be entered in several different formats and units.

Resistance values can be entered in integer, floating-point or exponential form. Valid units for a resistance parameter are:

UOHM -> Microohm
 MOHM -> Milliohm
 OHM -> Ohm
 KOHM -> Kiloohm
 MAOHM-> Megaohm

If the unit is omitted, the parameter is assumed to have ohm as the unit.

Examples of valid parameters for a resistance of 123.45 ohm are:

123.45, 123.45OHM, 0,12345KOHM, 123450MOHM, 123.45E-6MAOHM.

Format of the ON/OFF parameters

The ON/OFF parameters can be replaced by numeric parameters. The 2329 always responds with numeric values to a query form.

OFF -> 0
 ON -> 1

If only an instantaneous setting is requested, this parameter can be omitted from the query form of a command.

6.2.7 End-of-command character

A line feed (nl), semicolon (;) or EOI (IEEE488.1 end or identify), together with the character sent last (EOI only in the case of IEC bus control) indicate the end of a command.

For example, if the HP200/300 Basic "OUTPUT709;":INIT" is sent, the controller automatically appends a <cr><nl> to the command. With other IEC bus controllers such as a National PC card, the <nl> character might need to be entered explicitly (e.g.: ibwrt":init\n").

6.2.8 Special features of the RESISTOMAT®

Settings cannot be modified or read while a measurement is in progress. This means that the 2329 ignores all commands until the measurement is stopped. Exceptions here are the "ABORT" command for stopping a measurement, the commands for status-register control ("STATus") and the IEEE488.2 commands.

6.2.9 Effects of the "FETCh?" command while a continuous measurement is in progress

On the transmission of this command, the next available measurement value is written to the output buffer, from where it can be fetched (see „Command with query form“ auf Seite 68). After the value has been fetched, a new one is only written again to the output buffer the next time a "FETCh?" command is issued.

6.2.10 Status messages

Every SCPI device requires the status mechanism described in Chapter 11 of IEEE488.2, including the full implementation of the Event Status Register structure.

The following diagram shows the basic SCPI data structure with the related registers.

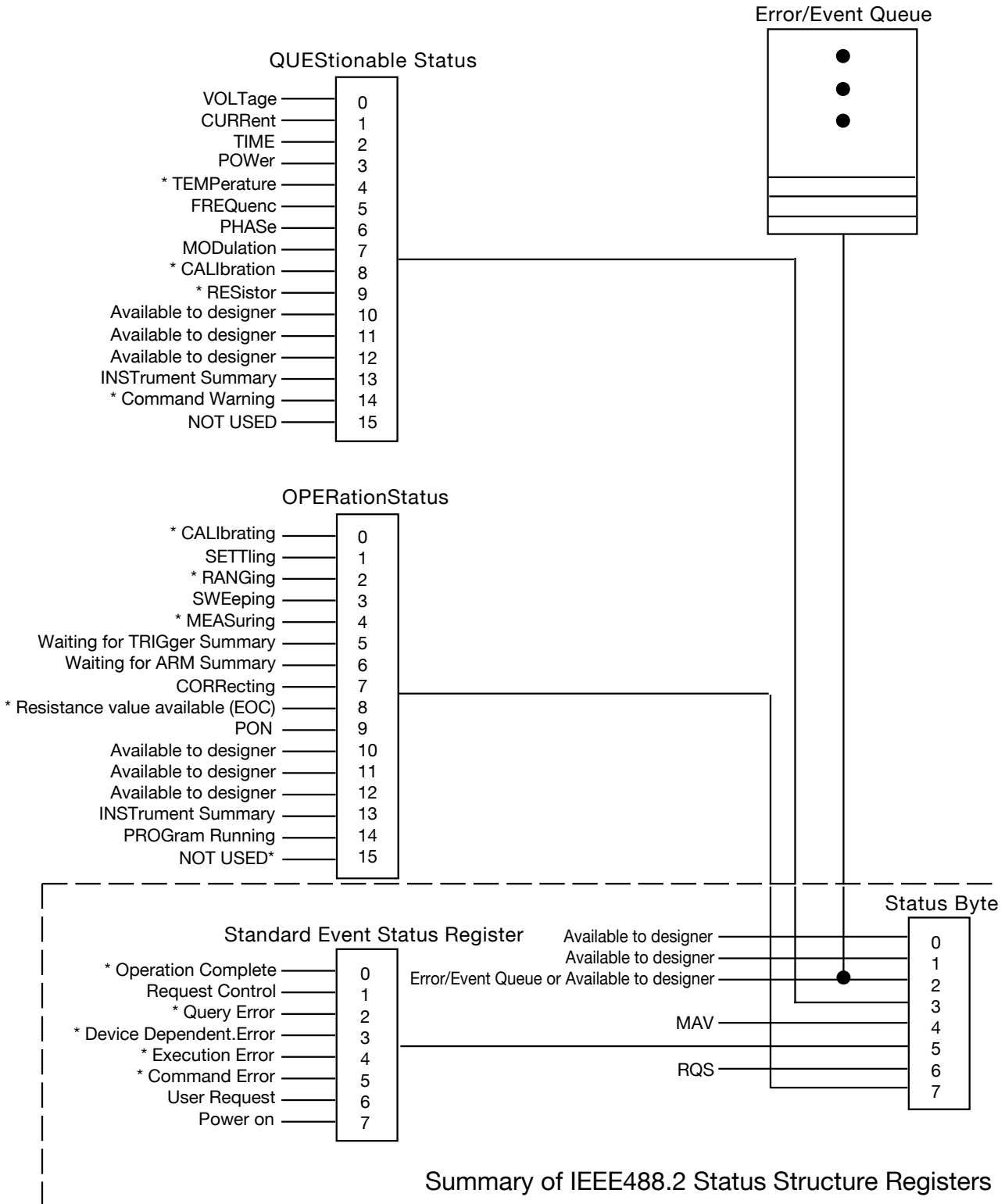

The events/functions marked with * are implemented inside the device.

6.2.11 Operation Status Register

The Operation Status Register indicates states which are part of the standard functions of the 2329. When a bit in the Operation Status Enable Register is enabled, the Operation Status Summary Bit (bit 7) in the Status Register is set. When bit 7 in the Service Request Enable Register is enabled, a Service Request is sent to the System Controller if the 2329 is being controlled via the IEC bus. The bits used by the 2329 are:

- 0 - Calibrating - The 2329 is performing a calibration.
- 2 - Ranging - The 2329 is changing measurement ranges.
- 4 - Measuring - The 2329 is performing a measurement.
- 8 - EOC - End of Conversion: This bit indicates that the 2329 has obtained a valid measurement value.
- 9 - PON - The 2329 has been switched on again. This bit will be deleted while reading out the register or *CLS.

The commands for controlling the Operation Status structure are:

STATus:OPERation:EVENT?
STATus:OPERation:ENABLE
STATus:OPERation:CONDition?

6.2.12 Questionable Status Register

The Questionable Status Register indicates that the data presently being recorded are invalid for some reason.

When a bit in the Questionable Status Register is set and the corresponding bit in the Questionable Status Enable Register enabled, the Questionable Status Summary bit (bit 3) in the Status Register is set. When bit 3 in the Service Request Enable Register is enabled, a Service Request is sent to the System Controller if the 2329 is being controlled via the IEEE488.

Bit 14 is the Command Warning bit which indicates that a parameter has been ignored during the processing of a command.

The commands for controlling the Questionable Status structure are:

STATus:QUESTionable:EVENT?
STATus:QUESTionable:ENABLE
STATus:QUESTionable:CONDition?

6.2.13 Standard Event Register

The Standard Event Register indicates various states of the 2329. When a bit in the Standard Event Register is set and the corresponding bit in the Standard Event Enable Register is enabled, bit 5 in the Status Register is set. When bit 5 in the Service Request Enable Register is enabled, a Service Request is sent to the System Controller if the 2329 is being controlled via the IEEE488.

The bits used in the 2329 have the following meanings:

- Bit 0 Operation Complete - This bit is set in response to the *OPC command. It indicates that the device has finished executing the selected operation.
- Bit 2 Query Error - A query error was detected. This bit indicates that either:
 - (1) data were requested although none are available,
 - (2) or data in the output buffer were lost.

Bit 3 Device Dep. Error The Device Dependent Error bit indicates that an error occurred during a measurement.

Bit 4 Execution Error The Execution Error bit is set on the transmission of an incorrect parameter.

Bit 5 Command Error The Command Error Bit is set when the SCPI interpreter fails to recognize a command.

The IEEE488.2 commands for controlling the Standard Event data structure are:

*ESR?

*ESE

*ESE?

6.2.14 Status Byte

The Status byte is used to summarize several Event Registers in a Status Register. The Status byte of every Event Register contains an Event Register Summary bit which indicates whether an event has occurred in the related Event Register. The Summary bit is only set if the corresponding bit in the Event Enable Register is set. When the Summary bit is set and bit in the Service Request Enable Register is enabled, a Service Request is sent to the System Controller if the 2329 is being controlled via the IEEE488.

The bits in the Status byte are:

Bits 0-2 Not used

Bit 3 Questionable Status Summary bit. This bit is set if an enabled bit has been set in the Questionable Event Enable Register of the Questionable Event Register.

Bit 4 MAV - Message Available. The MAV bit is set if data are available in the output buffer of the 2329.

Bit 5 ESB - Event Status Summary Bit. This bit indicates whether an enabled event has occurred in the Event Status Register of the 2329.

Bit 7 Operation Status Summary Bit. This bit is set if an enabled event has occurred in the Operation Status Register.

The IEEE488.2 commands for setting the Status data structure are:

*STB?

*SRE

*SRE?

6.3 SCPI commands

The SCPI commands are displayed in long and short form. The long form contains the entire command, while the short form consists of the sections indicated in upper case. Command sections enclosed in square brackets need not be transmitted.

Related parameters are appended with a blank character.
The commands can be entered in upper or lower case, long or short form.

The query form of a command is created by appending a question mark directly to the command. If a command is sent with a parameter, although no parameter is expected, the Command Warning bit (bit 14) in the Questionable Status Register is set. The parameter is ignored and no error is indicated.

On the occurrence of an error, the 2329 issues <NAK> instead of <ACK>. The cause of the error can be determined with the command ":SYSTem:ERRor?" (also described subsequently). In addition, the corresponding error bits are set in the Status Registers (refer to chapter 6.2.14, Status Register).

The SCPI version can be requested with the command SYSTem:VERSion?.

6.3.1 STATus Subsystem

STATus:OPERation:CONDition? (short form -> S:O:C?)

DESCRIPTION:	The Operation Status Condition Register is read out
SYNTAX:	STATus:OPERation:CONDition? or S:O:C?
PARAMETERS:	None
QUERY FORM:	Only query form. The contents of the 16 bit register are returned as a decimal value
RESTRICTIONS:	None

STATus:OPERation:ENABLE

DESCRIPTION:	The Operation Status Enable Register is set.
SYNTAX:	STATus:OPERation:ENABLE <parameter>
PARAMETERS:	Decimal value (value range: 0 to 32767)
QUERY FORM:	STATus:OPERation:ENABLE? The contents of the 16 bit register are returned as a decimal value.
RESTRICTIONS:	None

STATus:OPERation[:EVENT]? (short form -> S:O:E?)

DESCRIPTION:	The Operation Status Event Register is read out.
SYNTAX:	STATus:OPERation[:EVENT]? or S:O:E?
PARAMETERS:	None
QUERY FORM:	Only query form. The contents of the 16 bit register are returned as a decimal value.
RESTRICTION:	None

STATus:QUESTionable:CONDition? (short form -> S:Q:C?)

DESCRIPTION:	The Questionable Status Condition Register is read out.
SYNTAX:	STATus:QUESTionable:CONDition? oder S:Q:C?
PARAMETERS:	None
QUERY FORM:	Only query form. The contents of the 16 bit register are returned as a decimal value.
RESTRICTION:	None

STATus:QUESTionable:ENABle

DESCRIPTION:	The Questionable Enable Register is set.
SYNTAX:	STATus:QUESTionable:ENABle <parameter>
PARAMETERS:	Decimal value (value range: 0 to 32767).
QUERY FORM:	STATus:QUESTionable:ENABle? The contents of the 16 bit register are returned as a decimal value.
RESTRICTION:	None

STATus:QUESTionable[:EVENT]? (short form -> S:Q:E?)

DESCRIPTION:	The Questionable Status Event Register is read out.
SYNTAX:	STATus:QUESTionable[:EVENT]? or S:Q:E?
PARAMETERS:	None
QUERY FORM:	Only query form. The contents of the 16 bit register are returned as a decimal value.
RESTRICTION:	None

STATUS:QUESTIONable:FRESistance? (short form -> S:Q:F?)

DESCRIPTION:	The status of the resistance measurement is returned.
SYNTAX:	STATUS:QUESTIONable:FRESistance? or S:Q:F?
PARAMETERS:	None
QUERY FORM:	Only query form. The contents of the 8 bit register are returned as a hexadecimal value. If an error occurs, the corresponding bit is set to 1.
RESTRICTIONS:	None

Bit 7	Bit 6	Bit 5	Bit 4	Bit 3	Bit 2	Bit 1	Bit 0
Temperature compensation	U cable breakage	Current not settled	Underdrive limits of the A/D converter fallen short of	Overdrive limits of the A/D converter exceeded	I over resistance of the test object or line too high	MU over measurement amplifier of the potential taps overdriven	MI over resistance of the test object or line too high

STATUS:QUESTIONable:TEMPERature? (short form -> S:Q:T?)

DESCRIPTION:	The status of the temperature measurement is returned.
SYNTAX:	STATUS:QUESTIONable:TEMPERature? oder S:Q:T?
PARAMETERS:	None
QUERY FORM:	Only query form. The contents of the 8 bit register are returned as a hexadecimal value. In the event of an error, the corresponding bit is set to 1
RESTRICTIONS:	None

Bit 7	Bit 6	Bit 5	Bit 4	Bit 3	Bit 2	Bit 1	Bit 0
-	Voltage supply in measurement section not OK	Invalid temperature	Invalid resistance Pt100 might be reverse connected	I cable breakage or no Pt100	U cable breakage	I cable breakage	I cable breakage or high impedance

STATUS:PRESet

DESCRIPTION:	The Operation Status Enable Register and the Questionable Status Enable Register are reset.
SYNTAX:	STATUS:PRESet
PARAMETERS:	None
QUERY FORM:	None
RESTRICTIONS:	None

6.3.2 SYSTem Subsystem

SYSTem:ERRor?

DESCRIPTION:	The contents of the error buffer are requested.
SYNTAX:	SYSTem:ERRor?
PARAMETERS:	None
QUERY FORM:	Only query form
RESTRICTIONS:	None

List of error messages

-0, NO ERROR:	No error is present.
-100, COMMAND ERROR:	An invalid command was sent.
-101, INVALID CHARACTER:	The command contains an invalid character.
-105, GET NOT ALLOWED:	GET was sent within another command.
-109, MISSING PARAMETER:	A parameter is missing.
-110, COMMAND HEADER ERROR:	The command has an invalid header.
-120, NUMERIC DATA ERROR:	A numerical value is invalid.
-200, EXECUTION ERROR:	Due to a particular device state, the command could not be executed.
-204, ILLEGAL DEVICE STATE:	The command is valid but cannot be executed in the present state of the device.
-213, INIT IGNORED:	The INITialize command was ignored.
-220, PARAMETER ERROR:	The command has an invalid parameter.
-221, SETTING CONFLICT:	Due to particular setting, the command with the related parameter cannot be executed.
-222, DATA OUT OF RANGE:	A parameter lies outside the valid limits.
-224, ILLEGAL PARAMETER VALUE:	The parameter is valid but not used by the device.
-231, DATA QUESTIONABLE:	The value of a parameter is questionable.
-350, QUEUE OVERFLOW:	The error buffer has overflowed.
-400, QUERY ERROR:	A query was sent although no data are present.
-410, QUERY INTERRUPTED:	The device was interrupted before it could send a complete response.
-420, QUERY UNTERMINATED:	A response could not be terminated properly.

SYSTem:KLOCK

DESCRIPTION:	This locks the keypad of the device.
SYNTAX:	SYSTem:KLOCK <parameter>
PARAMETERS:	1 or ON -> The keypad is locked. 0 or OFF -> The keypad is released.
QUERY FORM:	SYSTem:KLOCK?
RESPONSE:	1, if the keypad is locked. 0, if the keypad is released.
RESTRICTION:	None

SYSTem:VERSion?

DESCRIPTION:	The SCPI version is requested.
SYNTAX:	SYSTem:VERSion?
PARAMETERS:	None
QUERY FORM:	Only query form
RESPONSE:	1995.0
RESTRICTION:	Keine

SYSTem:DATE

DESCRIPTION:	The date can be requested and adjusted here.
SYNTAX:	SYSTem:DATE <parameter>
PARAMETERS:	yyyy, mm, dd (year, month, day)
QUERY FORM:	SYSTem:DATE?
RESPONSE:	dd.mm.yy (day, month, year)
RESTRICTION:	None

SYSTem:TIME

DESCRIPTION:	The time can be requested and adjusted here
SYNTAX:	SYSTem:TIME <parameter>
PARAMETERS:	hh, mm, ss (hours, minutes, seconds)
QUERY FORM:	SYSTem:TIME?
RESPONSE:	hh:mm:ss (hours, minutes, seconds)
RESTRICTION:	None

6.3.3 DISPlay Subsystem

DISPlay:CONTRast

DESCRIPTION:	The LCD contrast is adjusted here.
SYNTAX:	DISPlay:CONTRast <parameter>
PARAMETERS:	A value between 0 and 1. 1 -> maximum contrast, 0 -> minimum contrast
QUERY FORM:	DISPlay:CONTRast?
RESPONSE:	A value between 0 and 1.
RESTRICTION:	This command is not permissible if a measurement is in progress or the device is in the calibration mode.

DISPlay:RANGe

DESCRIPTION:	This activates/deactivates the measurement range display in the main menu.
SYNTAX:	DISPlay:RANGe <parameter>
PARAMETERS:	1 or ON -> The measurement range is displayed. 0 or OFF -> The measurement range is not displayed
QUERY FORM:	DISPlay:RANGe?
RESPONSE:	1 -> If the measurement range display is active. 0 -> If the measurement range display is inactive.
RESTRICTION:	This command is not permissible if a measurement is in progress or the device is in the calibration mode.

DISPlay:CURRent

DESCRIPTION:	This activates/deactivates the measurement current display in the main menu.
SYNTAX:	DISPlay:CURRent <parameter>
PARAMETERS:	1 or ON -> The measurement current is displayed. 0 or OFF -> The measurement current is not displayed
QUERY FORM:	DISPlay:CURRent?
RESPONSE:	1 -> If the measurement current display is active. 0 -> If the measurement current display is inactive.
RESTRICTION:	This command is not permissible if a measurement is in progress or the device is in the calibration mode.

DISPlay:TEMPerature

DESCRIPTION:	This activates/inactivates the display of the temperature or setpoint value in the main menu.
SYNTAX:	DISPlay:TEMPerature <parameter>
PARAMETERS:	1 or ON -> Temperature or setpoint value display is on. 0 or OFF -> Temperature or setpoint value display is off.
QUERY FORM:	DISPlay:TEMPerature?
RESPONSE:	1 -> If the temperature or setpoint value display is on. 0 -> If the temperature or setpoint value display is off.
RESTRICTION:	This command is not permissible if a measurement is in progress or the device is in the calibration mode.

DISPlay:SAMPlE

DESCRIPTION:	This activates/inactivates the sample display in the main menu.
SYNTAX:	DISPlay:SAMPlE <parameter>
PARAMETERS:	1 or ON -> A sample signal is displayed. 0 or OFF -> A sample signal is not displayed.
QUERY FORM:	DISPlay:SAMPlE?
RESPONSE:	1 -> If a sample signal is displayed. 0 -> If a sample signal is not displayed.
RESTRICTION:	This command is not permissible if a measurement is in progress or the device is in the calibration mode.

DISPlay:TRIGger

DESCRIPTION:	The activates/deactivates the display of single and continuous measurement in the main menu.
SYNTAX:	DISPlay:TRIGger <parameter>
PARAMETERS:	1 or ON -> The display of single and continuous measurements is on. 0 or OFF-> The display of single and continuous measurements is off.
QUERY FORM:	DISPlay:TRIGger?
RESPONSE:	1 -> If single/continuous measurement display is on. 0 -> If single/continuous measurement display is off.
RESTRICTION:	This command is not permissible if a measurement is in progress or the device is in the calibration mode.

DISPlay:AUTO

DESCRIPTION:	The activates/deactivates the AUTO / display in the main menu.
SYNTAX:	DISPlay:AUTO <parameter>
PARAMETERS:	1 or ON -> AUTO / MAN display on. 0 or OFF -> AUTO / MAN display off.
QUERY FORM:	DISPlay:AUTO?
RESPONSE:	1 -> If AUTO / MAN display is on. 0 -> If AUTO / MAN display is off.
RESTRICTION:	This command is not permissible if a measurement is in progress or the device is in the calibration mode.

DISPlay:LOAD

DESCRIPTION:	This activates/deactivates the R/Z display in the main menu.
SYNTAX:	DISPlay:LOAD <parameter>
PARAMETERS:	1 or ON -> R/Z display is on. 0 or OFF -> R/Z display is off.
QUERY FORM:	DISPlay:LOAD?
RESPONSE:	1 -> If R/Z display is on 0 -> If R/Z display is off.
RESTRICTION:	This command is not permissible if a measurement is in progress or the device is in the calibration mode.

DISPlay:MEASure

DESCRIPTION:	The activates/deactivates the measured value display.
SYNTAX:	DISPlay:MEASure <parameter>
PARAMETERS:	1 or ON -> Measured value display is on. 0 or OFF -> Measured value display is off.
QUERY FORM:	DISPlay:MEASure?
RESPONSE:	1 -> If measured value display is on. 0 -> If measured value display is off.
RESTRICTION:	This command is not permissible if a measurement is in progress or the device is in the calibration mode. The measured value display is re-activated automatically in the local mode and when the device is turned on/off.

6.3.4. SOURce Subsystem

SOURce:VOLTage:LIMit:STATe

DESCRIPTION:	This activates/deactivates the 20 mV limiter.
SYNTAX:	SOURce:VOLTage:LIMit:STATe <parameter>
PARAMETERS:	1 or ON -> The 20 mV limiter is on. 0 or OFF -> The 20 mV limiter is off.
QUERY FORM:	SOURce:VOLTage:LIMit:STATe?
RESPONSE:	1 -> If the 20 mV limiter is on. 0 -> If the 20 mV limiter is off.
RESTRICTION:	This command is not permissible if a measurement is in progress or the device is in the calibration mode.

6.3.5 TRIGger Subsystem

INITiate:CONTInuous

DESCRIPTION:	This effects a switchover between single and continuous measurement.
SYNTAX:	INITiate:CONTInuous <parameter>
PARAMETERS:	1 or ON -> Continuous measurements is set. 0 or OFF -> Single measurements is set.
QUERY FORM:	INITiate:CONTInuous?
RESPONSE:	1 -> If continuous measurement is set. 0 -> If single measurement is set.
RESTRICTION:	This command is not permissible if a measurement is in progress or the device is in the calibration mode.

INITiate[:IMMediate] (Kurzform -> IN)

DESCRIPTION:	This commences a resistance measurement.
SYNTAX:	INITiate[:IMMediate]
PARAMETERS:	None
QUERY FORM:	None
RESPONSE:	—
REMARKS:	This command also exists in a special short form: IN
RESTRICTION:	This command is not permissible in the calibration mode.

ABORt (short form -> AB)

DESCRIPTION:	This stops a measurement.
SYNTAX:	ABORt
PARAMETERS:	None
QUERY FORM:	None
RESPONSE:	—
REMARKS:	This command also exists in a special short form: AB
RESTRICTION:	This command is not permissible in the calibration mode.

6.3.6 Measurement Instructions**FETCh? (Kurzform -> FE?)**

DESCRIPTION:	This requests a measured resistance value, which is subsequently written to the output buffer.
SYNTAX:	FETCh?
PARAMETERS:	None
QUERY FORM:	Only query form
RESPONSE:	The measured resistance value with a unit. and valuation For example: 134.75OHM
REMARKS:	This command also exists in a special short form: FE?
RESTRICTION:	This command is not permissible in the calibration mode or if a measurement has been stopped in the absence of any measured values.

6.3.7 MEMory Subsystem**MEMory:STATe:DEFine**

DESCRIPTION:	This assigns an ID to a memory number (device setting).
SYNTAX:	MEMory:STATe:DEFine <ID>,<number>
PARAMETERS:	Identification: 10-character ASCII string Number: Memory number from 0 to 32
QUERY FORM:	MEMory:STATe:DEFine? <ID>
RESPONSE:	The memory number (0 to 32) related to the ID is returned.
RESTRICTION:	This command is not permissible if a measurement is in progress or the device is in the calibration mode.

MEMory:STATe:NAME

DESCRIPTION:	This supplies the ID related to a memory number (device setting).
SYNTAX:	MEMory:STATe:NAME? <number>
PARAMETERS:	A memory number between 0 and 32
QUERY FORM:	Only query form.
RESPONSE:	An ID with a maximum length of 10 characters related to the memory number.
RESTRICTION:	This command is not permissible if a measurement is in progress or the device is in the calibration mode.

6.3.8 REGister Subsystem

REGister:OUTPut

DESCRIPTION:	This sets/resets the 3 spare outputs.		
	Bit 2	Bit 1	Bit 0
	SPARE OUTPUT 3	SPARE OUTPUT 2	SPARE OUTPUT 1
SYNTAX:	REGister:OUTPut <parameter>		
PARAMETERS:	A value between 0 and 7. The 3 spare outputs are set/reset in accordance with this value.		
QUERY FORM:	REGister:OUTPut?		
RESPONSE:	A value between 0 and 7, in accordance with the states of the spare outputs.		
RESTRICTION:	This command is not permissible if a measurement is in progress or the device is in the calibration mode.		

REGister:INPut?

DESCRIPTION:	This reads in the 4 spare inputs.			
SYNTAX:	REGister:INPut?			
PARAMETERS:	None			
QUERY FORM:	Only query form			
RESPONSE:	A value between 0 and 15, depending on the states of the spare inputs.			
	BIT 3	BIT 2	BIT 1	BIT 0
	SPARE INPUT 4	SPARE INPUT 3	SPARE INPUT 2	SPARE INPUT 1
RESTRICTION:	This command is not permissible if a measurement is in progress or the device is in the calibration mode.			

6.3.9 HCOPy Subsystem

HCOPy:ABORt

DESCRIPTION:	This stops the printer.
SYNTAX:	HCOPy:ABORt
PARAMETERS:	None
QUERY FORM:	HCOPy:ABORt?
RESPONSE:	1 -> If the printer function is on. 0 -> If the printer function is off.
RESTRICTION:	This command is not permissible in the calibration mode.

HCOPy[:IMMEDIATE]

DESCRIPTION:	This starts the printer.
SYNTAX:	HCOPy[:IMMEDIATE]
PARAMETERS:	None
QUERY FORM:	HCOPy[:IMMEDIATE]?
RESPONSE:	1 -> If the printer function is on. 0 -> If the printer function is off.
RESTRICTION:	This command is not permissible in the calibration mode.

HCOPy:ITEM:TEMPERature:STATe

DESCRIPTION:	This activates/deactivates temperature printout.
SYNTAX:	HCOPy:ITEM:TEMPERature:STATe <parameter>
PARAMETERS:	1 or ON -> The temperature is printed out. 0 or OFF -> The temperature is not printed out.
QUERY FORM:	HCOPy:ITEM:TEMPERature:STATe?
RESPONSE:	1 -> If temperature printout is active. 0 -> If temperature printout is inactive.
REMARKS:	The temperature is only printed out if temperature compensation is also active.
RESTRICTION:	This command is not permissible if a measurement is in progress or the device is in the calibration mode.

HCOPY:ITEM:NUMerator:STATe

DESCRIPTION:	This activates/deactivates printing of the numerator.
SYNTAX:	HCOPY:ITEM:NUMerator:STATe <parameter>
PARAMETERS:	1 or ON -> The numerator is printed out. 0 or OFF -> The numerator is not printed out.
QUERY FORM:	HCOPY:ITEM:NUMerator:STATe?
RESPONSE:	1 -> If numerator printout is active. 0 -> If numerator printout is inactive.
RESTRICTION:	This command is not permissible if a measurement is in progress or the device is in the calibration mode.

HCOPY:ITEM:LABel:STATe

DESCRIPTION:	This activates/deactivates labelling.
SYNTAX:	HCOPY:ITEM:LABel:STATe <parameter>
PARAMETERS:	1 or ON -> The label is printed out in the header. 0 or OFF -> The label is not printed out in the header.
QUERY FORM:	HCOPY:ITEM:LABel:STATe?
RESPONSE:	1 -> If label printout is active. 0 -> If label printout is inactive.
RESTRICTION:	This command is not permissible if a measurement is in progress or the device is in the calibration mode.

HCOPY:ITEM:TIME:STATe

DESCRIPTION:	This activates/deactivates printing of the time.
SYNTAX:	HCOPY:ITEM:TIME:STATe <parameter>
PARAMETERS:	1 or ON -> The time is printed out. 0 or OFF -> The time is not printed out.
QUERY FORM:	HCOPY:ITEM:TIME:STATe?
RESPONSE:	1 -> If time printout is active. 0 -> If time printout is inactive.
RESTRICTION:	This command is not permissible if a measurement is in progress or the device is in the calibration mode.

HCOPy:ITEM:Date:STATe

DESCRIPTION:	This activates/deactivates printing of the date.
SYNTAX:	HCOPy:DATE:LABel:STATe <parameter>
PARAMETERS:	1 or ON -> The date is printed out. 0 or OFF -> The date is not printed out.
QUERY FORM:	HCOPy:DATE:LABel:STATe?
RESPONSE:	1 -> If date printout is active. 0 -> If date printout is inactive.
RESTRICTION:	This command is not permissible if a measurement is in progress or the device is in the calibration mode.

HCOPy:NUMerator:RESet

DESCRIPTION:	This resets the numerator to 0.
SYNTAX:	HCOPy:NUMerator:RESet
PARAMETERS:	None
QUERY FORM:	No query form
RESPONSE:	—
RESTRICTION:	This command is not permissible if a measurement is in progress or the device is in the calibration mode.

HCOPy:ITEM:LABel:TEXT

DESCRIPTION:	This requests the label for printout.
SYNTAX:	HCOPy:ITEM:LABel:TEXT <label>
PARAMETERS:	Label (ASCII string) with a maximum length of 10 characters.
QUERY FORM:	HCOPy:ITEM:LABel:TEXT?
RESPONSE:	The selected label with a maximum length of 10 characters.
RESTRICTION:	This command is not permissible if a measurement is in progress or the device is in the calibration mode.

HCOPy:TDSTam

DESCRIPTION:	This sets the printing time interval.
SYNTAX:	HCOPy:TDSTam <hh>,<mm>,<ss>
PARAMETERS:	The printing time interval: hh,mm,ss. The hours, minutes and seconds are separated from each other with commas.
QUERY FORM:	HCOPy:TDSTam?
RESPONSE:	The selected printing time interval: hh,mm,ss. The hours, minutes and seconds are separated from each other with commas:
RESTRICTION:	This command is not permissible if a measurement is in progress or the device is in the calibration mode.

HCOPy:HEADer

DESCRIPTION:	This sets the number of measured values to be printed out per header.
SYNTAX:	HCOPy:HEADer <parameter>
PARAMETERS:	Measured values/header: A number between 1 and 1000.
QUERY FORM:	HCOPy:HEADer?
RESPONSE:	The selected number: Measured values/header.
RESTRICTION:	This command is not permissible if a measurement is in progress or the device is in the calibration mode.

6.3.10 CALCulate Subsystem

CALCulate:LIMit:STATe

DESCRIPTION:	This activates/deactivates the comparator.
SYNTAX:	CALCulate:LIMit:STATe <parameter>
PARAMETERS:	1 or ON -> The comparator is on. 0 or OFF -> The comparator is off.
QUERY FORM:	CALCulate:LIMit:STATe?
RESPONSE:	1 -> If the comparator is on. 0 -> If the comparator is off.
RESTRICTION:	This command is not permissible in the calibration mode.

CALCulate:LIMit:COUNT

DESCRIPTION:	This sets the number of limiting values (2 or 4) for the comparator.
SYNTAX:	CALCulate:LIMit:COUNT <parameter>
PARAMETERS:	2 -> 2 limiting values are set. 4 -> 4 limiting values are set.
QUERY FORM:	CALCulate:LIMit:COUNT?
RESPONSE:	2 -> If 2 limiting values have been set. 4 -> If 4 limiting values have been set.
RESTRICTION:	This command is not permissible if a measurement is in progress or the device is in the calibration mode.

CALCulate:LIMit:RELais

DESCRIPTION:	This activates/deactivates the comparator relay.
SYNTAX:	CALCulate:LIMit:RELais <parameter>
PARAMETERS:	1 or ON -> The relay is turned on. 0 or OFF-> The relay is turned off.
QUERY FORM:	CALCulate:LIMit:RELais?
RESPONSE:	1 -> The relay is on. 0 -> The relay is off.
RESTRICTION:	This command is not permissible if a measurement is in progress or the device is in the calibration mode.

CALCulate:LIMit:FAULt

DESCRIPTION:	This specifies the comparator's response in the event of a measurement error.
SYNTAX:	CALCulate:LIMit:FAULt <parameter>
PARAMETERS:	UPPer -> In the event of an error, the comparator indicates that the measured value is too high.
	NONE -> The comparator does not respond in the event of an error.
QUERY FORM:	CALCulate:LIMit:FAULt?
RESPONSE:	UPPER -> If the comparator indicates that the measured value is too high in the event of an error.
	NONE -> If the comparator does not respond in the event of an error.
RESTRICTIONS:	This command is not permissible if a measurement is in progress or the device is in the calibration mode.

CALCulate:MATH:EXPRession

DESCRIPTION:	This sets the measurement-value display mode.
SYNTAX:	CALCulate:MATH:EXPRession <parameter>
PARAMETERS:	OHM -> Measured values are displayed in OHM. DELTA -> Measured values are displayed as Δ % of a setpoint value. LIMit -> The evaluation is displayed.
QUERY FORM:	CALCulate:MATH:EXPRession?
RESPONSE:	OHM -> If the OHM display has been selected. DELTA -> If the Δ % display has been selected. LIMIT -> If the evaluation display has been selected.
RESTRICTIONS:	This command is not permissible if a measurement is in progress or the device is in the calibration mode.

CALCulate:LIMit:LOWer

DESCRIPTION:	This specifies the lower limit when 2 comparator limits are selected.
SYNTAX:	CALCulate:LIMit:LOWer <parameter>
PARAMETERS:	The lower limit with an optional unit. Valid units: UOHM, MOHM, OHM, KOHM, MAOHM. If no unit is specified, the unit of the value is interpreted as OHM.
QUERY FORM:	CALCulate:LIMit:LOWer?
RESPONSE:	The lower limit of 2 comparator limits (value with unit).
BEMERKUNGEN:	The value transferred with this command needs to be acknowledged with CALCulate:LIMit:ACKnowledge (page 103). The validity of this value is tested with respect to the remaining limits.
RESTRICTIONS:	This command is not permissible if a measurement is in progress or the device is in the calibration mode.

CALCulate:LIMit:UPPer

DESCRIPTION	This specifies the upper limit when 2 comparator limits are selected.
SYNTAX	CALCulate:LIMit:UPPer <parameter>
PARAMETERS	The upper limit with an optional unit. Valid units: UOHM, MOHM, OHM, KOHM, MAOHM. If no unit is specified, the unit of the value is interpreted as OHM.
QUERY FORM	CALCulate:LIMit:UPPer?
RESPONSE	The upper limit of 2 comparator limits (value with unit).
BEMERKUNGEN	The value transferred with this command needs to be acknowledged with CALCulate:LIMit:ACKnowledge (page 103). The validity of this value is tested with respect to the remaining limits.
RESTRICTIONS	This command is not permissible if a measurement is in progress or the device is in the calibration mode.

CALCulate:LIMit:GW1

DESCRIPTION:	This specifies limiting value 1 (smallest value GW1) when 4 comparator limits are selected.
SYNTAX:	CALCulate:LIMit:GW1<parameter>
PARAMETERS:	Limit 1 with an optional unit. Valid units: UOHM, MOHM, OHM, KOHM, MAOHM. If no unit is specified, the unit of the value is interpreted as OHM.
QUERY FORM:	CALCulate:LIMit:GW1?
RESPONSE:	Limit 1 of 4 selected comparator limits (value with unit).
BEMERKUNGEN:	The value transferred with this command needs to be acknowledged with CALCulate:LIMit:ACKnowledge (page 100). The validity of this value is tested with respect to the remaining limits.
RESTRICTIONS:	This command is not permissible if a measurement is in progress or the device is in the calibration mode.

CALCulate:LIMit:GW2

DESCRIPTION:	This specifies limiting value 2 (third largest value GW2) when 4 comparator limits are selected.
SYNTAX:	CALCulate:LIMit:GW2<parameter>
PARAMETERS:	Limit 2 with an optional unit. Valid units: UOHM, MOHM, OHM, KOHM, MAOHM. If no unit is specified, the unit of the value is interpreted as OHM.
QUERY FORM:	CALCulate:LIMit:GW2?
RESPONSE:	Limit 2 of 4 selected comparator limits (value with unit).
BEMERKUNGEN:	The value transferred with this command needs to be acknowledged with CALCulate:LIMit:ACKnowledge (page 103). The validity of this value is tested with respect to the remaining limits.
RESTRICTIONS:	This command is not permissible if a measurement is in progress or the device is in the calibration mode.

CALCulate:LIMit:GW3

DESCRIPTION:	This specifies limiting value 3 (second largest value GW3) when 4 comparator limits are selected.
SYNTAX:	CALCulate:LIMit:GW3<parameter>
PARAMETERS:	Limit 3 with an optional unit. Valid units: UOHM, MOHM, OHM, KOHM, MAOHM. If no unit is specified, the unit of the value is interpreted as OHM.
QUERY FORM:	CALCulate:LIMit:GW3?
RESPONSE:	Limit 3 of 4 selected comparator limits (value with unit).
BEMERKUNGEN:	The value transferred with this command needs to be acknowledged with CALCulate:LIMit:ACKnowledge. The validity of this value is tested with respect to the remaining limits.
RESTRICTIONS:	This command is not permissible if a measurement is in progress or the device is in the calibration mode.

CALCulate:LIMit:GW4

DESCRIPTION:	This specifies limiting value 4 (largest value GW4) when 4 comparator limits are selected.
SYNTAX:	CALCulate:LIMit:GW4<parameter>
PARAMETERS:	Limit 4 with an optional unit. Valid units: UOHM, MOHM, OHM, KOHM, MAOHM. If no unit is specified, the unit of the value is interpreted as OHM.
QUERY FORM:	CALCulate:LIMit:GW4?
RESPONSE:	Limit 4 of 4 selected comparator limits (value with unit).
BEMERKUNGEN:	The value transferred with this command needs to be acknowledged with CALCulate:LIMit:ACKnowledge (page 103). The validity of this value is tested with respect to the remaining limits.
RESTRICTIONS:	This command is not permissible if a measurement is in progress or the device is in the calibration mode.

CALCulate:LIMit:ACKnowledge?

DESCRIPTION:.	This tests and saves the comparator limits.
SYNTAX:	CALCulate:LIMit:ACKnowledge?
PARAMETERS:	None
QUERY FORM:	Only query form
RESPONSE:	1 -> If the limit test is OK, the values are saved. 0 -> If the limit test is not OK, the values are not saved.
RESTRICTIONS:	This command is not permissible if a measurement is in progress or the device is in the calibration mode.

CALCulate:LIMit:CLEar

DESCRIPTION:	This deletes the statistical results provided by the comparator.
SYNTAX:	CALCulate:LIMit:CLEar
PARAMETERS:	None
QUERY FORM:	No query form
RESPONSE:	—
RESTRICTIONS:	This command is not permissible if a measurement is in progress or the device is in the calibration mode.

CALCulate:LIMit:REPort

DESCRIPTION:	This requests the statistical results provided by the comparator.
SYNTAX:	CALCulate:LIMit:REPort?
PARAMETERS:	None
QUERY FORM:	Only query form
RESPONSE:	<p>If 2 limits are set: value1, value2, value3 value1: No. of meas. values < lower limit value2: Lower limit >=No. of meas. values<=upper limit value3: No. of meas. values > upper limit</p> <p>If 4 limits are set: value1, value2, value3, value4, value5 value1: No. of meas. values < limit1 value2: limit1 >= No. of meas. values < limit2 value3: limit2 >= No. of meas. values <= limit3 value4: limit3 > No. of meas. values <= limit4 value5: No. of meas. values > limit4.</p>
RESTRICTIONS:	This command is not permissible if a measurement is in progress or the device is in the calibration mode.

6.3.11 SENSE Subsystem

SENSe:TCOMpensate

DESCRIPTION:	This sets the type of temperature measurement for temperature compensation.
SYNTAX:	SENSe:TCOMpensate <parameter>
PARAMETERS:	<p>MAN -> The temperature value entered via the interface or keypad is used.</p> <p>Pt100 -> Measurement via the Pt100 input.</p> <p>UINP -> Measurement via the external U-input.</p> <p>IINP -> Measurement via the external I-input.</p>
QUERY FORM:	SENSe:TCOMpensate?
RESPONSE:	<p>MAN -> If manual temperature entry is selected.</p> <p>Pt100 -> If temperature measurement via the Pt100 is selected.</p> <p>UINP -> If temperature measurement via the ext. U-input is selected.</p> <p>IINP -> If temperatu</p>
RESTRICTIONS:	This command is not permissible if a measurement is in progress or the device is in the calibration mode.

SENSe:FRESistance:REFerence

DESCRIPTION:	This select the reference value for Δ % display.
SYNTAX:	SENSe:FRESistance:REFerence <parameter>
PARAMETERS:	The reference value, optionally with a unit. Valid units: UOHM, MOHM, OHM, KOHM, MAOHM If no unit is specified, the unit of the value is interpreted as OHM.
QUERY FORM:	SENSe:FRESistance:REFerence?
RESPONSE:	The selected reference value and unit.
RESTRICTIONS:	This command is not permissible if a measurement is in progress or the device is in the calibration mode.

SENSe:ENVELOpe:STATe

DESCRIPTION:	This activates/deactivates the max./min. function
SYNTAX:	SENSe:ENVELOpe:STATe <parameter>
PARAMETERS:	1 or ON -> The max./min. function is on. 0 or OFF -> The max./min. function is off.
QUERY FORM:	SENSe:ENVELOpe:STATe?
RESPONSE:	1 -> If the max./min. function is on. 0 -> If the max./min. function is off.
RESTRICTIONS:	This command is not permissible if the device is in the calibration mode.

SENSe:TCOMpensate:STATe

DESCRIPTION:	This activates/deactivates temperature compensation.
SYNTAX:	SENSe:TCOMpensate:STATe <parameter>
PARAMETERS:	1 or ON -> Temperature compensation is on. 0 or OFF -> Temperature compensation is off.
QUERY FORM:	SENSe:TCOMpensate:STATe?
RESPONSE:	1 -> If temperature compensation is on. 0 -> If temperature compensation is off.
RESTRICTIONS:	This command is not permissible if a measurement is in progress or the device is in the calibration mode.

SENSe:ENVELOpe:CLEAr

DESCRIPTION:	This deletes the minimum and maximum values.
SYNTAX:	SENSe:ENVELOpe:CLEAr
PARAMETERS:	None
QUERY FORM:	No query form
RESPONSE:	—
RESTRICTIONS:	This command is not permissible if a measurement is in progress or the device is in the calibration mode.

SENSe:TCOMpensate:TEMPerature

DESCRIPTION:	This sets the temperature for manual temperature compensation. In the query form you get the present temperature.
SYNTAX:	SENSe:TCOMpensate:TEMPerature <parameter>
PARAMETERS:	Temperature value, optionally with a unit (C or CEL)
QUERY FORM:	SENSe:TCOMpensate:TEMPerature?
RESPONSE:	The set temperature value and a corresponding unit (CEL) or the topical temperature at autom. temp. measurement.
RESTRICTIONS:	This command is not permissible if a measurement is in progress or the device is in the calibration mode.

SENSe:FRESistance:LOAD

DESCRIPTION:	This selects the type of test object (R or Z).
SYNTAX:	SENSe:FRESistance:LOAD <parameter>
PARAMETERS:	REAL -> R is set (purely ohmic load) COMPLex -> Z is set (inductive component)
QUERY FORM:	SENSe:FRESistance:LOAD?
RESPONSE:	REAL -> If R is set. COMP -> If Z is set.
RESTRICTIONS:	This command is not permissible if a measurement is in progress or the device is in the calibration mode.

SENSe:AVERage:COUNT

DESCRIPTION:	This sets the number of averaging operations.
SYNTAX:	SENSe:AVERage:COUNT <parameter>
PARAMETERS:	Number of averaging operations. Value range: 1 to 100
QUERY FORM:	SENSe:AVERage:COUNT?
RESPONSE:	The set number of averaging operations.
RESTRICTIONS:	This command is not permissible if a measurement is in progress or the device is in the calibration mode.

SENSe:AVERage:TCONtrol

DESCRIPTION:	The selects the type of averaging operation.
SYNTAX:	SENSe:AVERage:TCONtrol <parameter>
PARAMETERS:	MOVing -> A moving average value is formed. REPeat -> Average values are formed repeatedly.
QUERY FORM:	SENSe:AVERage:TCONtrol?
RESPONSE:	MOV -> If a moving average value is selected. REP -> If a refreshed average value is selected.
RESTRICTIONS:	This command is not permissible if a measurement is in progress or the device is in the calibration mode.

SENSe:FRESistance:RESolution

DESCRIPTION:	This sets the resolution for the measurement-value display.
SYNTAX:	SENSe:FRESistance:RESolution <parameter>
PARAMETERS:	0.0005 -> A low resolution (2000) is set. 0.00005 -> A high resolution (20000) is set.
QUERY FORM:	SENSe:FRESistance:RESolution?
RESPONSE:	0.0005 -> If a low resolution has been set. 0.00005 -> If a high resolution has been set.
RESTRICTIONS:	This command is not permissible if a measurement is in progress or the device is in the calibration mode.

SENSe:FRESistance:NPLCycles

DESCRIPTION:	This sets the number of conversions.
SYNTAX:	SENSe:FRESistance:NPLCycles <parameter>
PARAMETERS:	Number of conversions (4 stages). MAXimum, STANdard, MEDium or MINimum
QUERY FORM:	SENSe:FRESistance:NPLCycles?
RESPONSE:	Selected conversion stage. (MAXimum, STANdard, MEDium or MINimum)
RESTRICTIONS:	This command is not permissible if a measurement is in progress or the device is in the calibration mode.

SENSe:FRESistance:MODE

DESCRIPTION:	This sets the type of measurement procedure.
SYNTAX:	SENSe:FRESistance:MODE <parameter>
PARAMETERS:	REFComp -> Zero measurement. NONComp -> No zero measurement. ONEComp -> Single zero measurement at the start. STANdard -> Alternate zero measurement and measurement with the power on. ITEST -> Measuring current monitoring (continuity tester)
QUERY FORM:	SENSe:FRESistance:MODE?
RESPONSE:	REFC -> If zero measurement is selected. NONC -> If no zero measurement is selected. ONEC -> If single zero measurement is selected. STAN -> If alternate zero measurement and power-on measurement are selected ITEST -> Measuring current monitoring (continuity tester)
	This command is not permissible if a measurement is in progress or the device is in the calibration mode.

SENSe:ENVELOpe:REPort:DATA

DESCRIPTION:	The maximum and minimum values can be fetched.
SYNTAX:	SENSe:ENVELOpe:REPort:DATA?
PARAMETERS:	None
QUERY FORM:	Only query form
RESPONSE:	Minimum value, maximum value, difference
RESTRICTIONS:	This command is not permissible if a measurement is in progress or the device is in the calibration mode.

SENSe:TCOMpensate:TCOefficient:SElect

DESCRIPTION:	This selects one of 10 different temperature coefficients.
SYNTAX:	SENSe:TCOMpensate:TCOefficient:SElect <parameter>
PARAMETERS:	A value between 1 and 10 (number of the coefficient)
QUERY FORM:	SENSe:TCOMpensate:TCOefficient:SElect?
RESPONSE:	The value of the present temperature coefficient.
RESTRICTIONS:	This command is not permissible if a measurement is in progress or the device is in the calibration mode.

SENSe:TCOMpensate:TEMPerature:REFerence

DESCRIPTION:	This sets the reference temperature for temperature compensation.
SYNTAX:	SENSe:TCOMpensate:TEMPerature:REFerence <parameter>
PARAMETERS:	The reference temperature, optionally with a unit (C or CEL).
QUERY FORM:	SENSe:TCOMpensate:TEMPerature:REFerence?
RESPONSE:	The selected reference temperature and a corresponding unit (CEL).
RESTRICTIONS:	This command is not permissible if a measurement is in progress or the device is in the calibration mode.

SENSe:TCOMpensate:TCOefficient

DESCRIPTION:	This selects one of 10 different temperature coefficients.
SYNTAX:	SENSe:TCOMpensate:TCOefficient <number>, <value>
PARAMETERS:	Number -> The number of the coefficient (1 to 10) Value -> The value of the temperature coefficient. (Value range: - 9999 to 9999)
QUERY FORM:	SENSe:TCOMpensate:TCOefficient? <number>
RESPONSE:	The temperature coefficient related to the number.
RESTRICTIONS:	This command is not permissible if a measurement is in progress or the device is in the calibration mode.

SENSe:FRESistance:RANGe:AUTO

DESCRIPTION:	This effects a switchover between automatic and manual range selection. With the query form the present range will send devide with a comma.
SYNTAX:	SENSe:FRESistance:RANGe:AUTO <parameter>
PARAMETERS:	1 or ON -> Automatic range selection is active. 0 or OFF -> Manual range selection is active.
QUERY FORM:	SENSe:FRESistance:RANGe:AUTO?
RESPONSE:	1.2 OHM -> If automatic range selection and range 2Ω is active. 0.2 OHM -> If manual range selection and range 2Ω is active.
RESTRICTIONS:	This command is not permissible if a measurement is in progress or the device is in the calibration mode.

SENSe:FRESistance:RANGe:UPPer

DESCRIPTION:	This sets the largest permissible measurement range for automatic range selection.
SYNTAX:	SENSe:FRESistance:RANGe:UPPer <parameter>
PARAMETERS:	2OHM -> largest range is 2 Ω. 20OHM -> largest range is 20 Ω. 200OHM -> largest range is 200 Ω. 2KOHM -> largest range is 2 kΩ. 20KOHM -> largest range is 20 kΩ. 200kOHM -> largest range is 200 kΩ.
QUERY FORM:	SENSe:FRESistance:RANGe:UPPer?
RESPONSE:	2OHM -> if largest range is 2 Ω. 20OHM -> if largest range is 20 Ω. 200OHM -> if largest range is 200 Ω. 2KOHM -> if largest range is 2 kΩ. 20KOHM -> if largest range is 20 kΩ. 200kOHM -> if largest range is 200 kΩ.
RESTRICTIONS:	This command is not permissible if a measurement is in progress or the device is in the calibration mode.

SENSe:FRESistance:RANGe:LOWer

DESCRIPTION:	This sets the smallest permissible measurement range for automatic range selection.
SYNTAX:	SENSe:FRESistance:RANGe:LOWer <parameter>
PARAMETERS:	200MOHM -> smallest range is 200 mΩ. 2OHM -> smallest range is 2 Ω. 20OHM -> smallest range is 20 Ω. 200OHM -> smallest range is 200 Ω. 2KOHM -> smallest range is 2 kΩ. 20kOHM -> smallest range is 20 kΩ.
QUERY FORM:	SENSe:FRESistance:RANGe:LOWer?
RESPONSE:	200MOHM -> if smallest range is 200 mΩ. 2OHM -> if smallest range is 2 Ω. 20OHM -> if smallest range is 20 Ω. 200OHM -> if smallest range is 200 Ω. 2KOHM -> if smallest range is 2 kΩ. 20kOHM -> if smallest range is 20 kΩ.
RESTRICTIONS:	This command is not permissible if a measurement is in progress or the device is in the calibration mode.

SENSe:FRESistance:RANGe:MANual

DESCRIPTION:	This sets the measuring range for manual range selection.
SYNTAX:	SENSe:FRESistance:RANGe:MANual <parameter>
PARAMETERS:	200MOHM -> manual range is 200 mΩ. 2OHM -> manual range is 2 Ω. 20OHM -> manual range is 20 Ω. 200OHM -> manual range is 200 Ω. 2KOHM -> manual range is 2 kΩ. 20KOHM -> manual range is 20 kΩ. 200KOHM -> manual range is 200 kΩ.
QUERY FORM:	SENSe:FRESistance:RANGe:MANual?
RESPONSE:	200MOHM -> if manual range is 200 mΩ. 2OHM -> if manual range is 2 Ω. 20OHM -> if manual range is 20 Ω. 200OHM -> if manual range is 200 Ω. 2KOHM -> if manual range is 2 kΩ. 20KOHM -> if manual range is 20 kΩ. 200KOHM -> if manual range is 200 kΩ.
RESTRICTIONS:	This command is not permissible if a measurement is in progress or the device is in the calibration mode.

5.3.12 SCALe Subsystem

SCALe:Pt100

DESCRIPTION:	This specifies the coefficient for the Pt100 curve in the range ≥ 0 C°.
SYNTAX:	SCALe:Pt100 <R₀>,<A>,
PARAMETERS:	R ₀ , A, B : The 3 coefficients are represented in the following equation: $R_t = R_0 * (1 + A * t + B * t^2)$
QUERY FORM:	SCALe:Pt100?
RESPONSE:	R ₀ , A, B : The actual constants.
RESTRICTIONS:	This command is not permissible if a measurement is in progress or the device is in the calibration mode.

SCALE:VOLTage

DESCRIPTION:	This scales the external U-input.
SYNTAX:	SCALE:VOLTage <u1>,<u2>,<t1>,<t2>
PARAMETERS:	u1: Current value 1 (related to t1) u2: Current value 2 (related to t2) t1: Temperature value 1 (related to u1) t2: Temperature value 2 (related to u2) Both pairs of values are used to calculate the linearization curve.
QUERY FORM:	SCALE:VOLTage?
RESPONSE:	u1,u2,t1,t2
RESTRICTIONS:	This command is not permissible if a measurement is in progress or the device is in the calibration mode.

SCALE:CURRent

DESCRIPTION:	This scales the external I-input.
SYNTAX:	SCALE:CURRent <i1>,<i2>,<t1>,<t2>
PARAMETERS:	i1: Current value 1 (related to t1) i2: Current value 2 (related to t2) t1: Temperature value 1 (related to u1) t2: Temperature value 2 (related to u2) Both pairs of values are used to calculate the linearization curve.
QUERY FORM:	SCALE:CURRent?
RESPONSE:	i1,i2,t1,t2
RESTRICTIONS:	This command is not permissible if a measurement is in progress or the device is in the calibration mode.

6.3.13 ACCess Subsystem

ACCess:MEASure

DESCRIPTION:	This enables/disables access to the measurement-parameter menu.
SYNTAX:	ACCess : MEASure <parameter>
PARAMETERS:	1 or ON -> Enables access to the measurement-parameter menu. 0 or OFF ->Disables access to the measurement-parameter menu.
QUERY FORM:	ACCess:MEASure?
RESPONSE:	1 ->If access to the measurement-parameter menu is enabled. 0 ->If access to the measurement-parameter menu is disabled.
RESTRICTIONS:	This command is not permissible if a measurement is in progress or the device is in the calibration mode.

ACCess:EXPRession

DESCRIPTION:	This enables/disables access to the display-mode menu.
SYNTAX:	ACCess : EXPRession <parameter>
PARAMETERS:	1 or ON -> Enables access to the display-mode menu. 0 or OFF ->Disables access to the display-mode menu.
QUERY FORM:	ACCess:EXPRession?
RESPONSE:	1 ->If access to the display-mode menu is enabled. 0 ->If access to the display-mode menu is disabled.
RESTRICTIONS:	This command is not permissible if a measurement is in progress or the device is in the calibration mode.

ACCess:PRINter

DESCRIPTION:	This enables/disables access to the printer menu.
SYNTAX:	ACCess:PRINter <parameter>
PARAMETERS:	1 or ON -> Enables access to the printer menu. 0 or OFF -> Disables access to the printer menu.
QUERY FORM:	ACCess:PRINter?
RESPONSE:	1 -> If access to the printer menu is enabled. 0 ->If access to the printer menu is disabled.
RESTRICTIONS:	This command is not permissible if a measurement is in progress or the device is in the calibration mode.

ACCess:COMPensation

DESCRIPTION:	This enables/disables access to the temperature-compensation menu.
SYNTAX:	ACCess:COMPensation <parameter>
PARAMETERS:	1 or ON -> Enables access to the temperature-compensation menu. 0 or OFF -> Disables access to the temperature-compensation
QUERY FORM:	ACCess:COMPensation?
RESPONSE:	1 -> If access to the temperature-compensation menu is enabled. 0 -> If access to the temperature-compensation menu is disabled.
RESTRICTIONS:	This command is not permissible if a measurement is in progress or the device is in the calibration mode.

ACCess:COMMunicate

DESCRIPTION: This enables/disables access to the interface menu.

SYNTAX:	ACCess:COMMunicate <parameter>
PARAMETERS:	1 or ON -> Enables access to the interface menu. 0 or OFF -> Disables access to the interface menu.
QUERY FORM:	ACCess:COMMunicate?
RESPONSE:	1 -> If access to the interface menu is enabled. 0 -> If access to the interface menu is disabled.
RESTRICTIONS:	This command is not permissible if a measurement is in progress or the device is in the calibration mode.

ACCess:MEMory

DESCRIPTION:	This enables/disables access to the device-setting menu (for saving and loading device settings).
SYNTAX:	ACCess:MEMory <parameter>
PARAMETERS:	1 or ON -> Enables access to the device-setting menu. 0 or OFF -> Disables access to the device-setting menu.
QUERY FORM:	ACCess:MEMory?
RESPONSE:	1 ->If access to the device-setting menu is enabled. 0 ->If access to the device-setting menu is disabled.
RESTRICTIONS:	This command is not permissible if a measurement is in progress or the device is in the calibration mode.

ACCess:CONTrast

DESCRIPTION:	This enables/disables access to the contrast-setting menu.
SYNTAX:	ACCess:CONTrast <parameter>
PARAMETERS:	1 or ON -> Enables access to the contrast-setting menu. 0 or OFF -> Disables access to the contrast-setting menu.
QUERY FORM:	ACCess:CONTrast?
RESPONSE:	1 -> If access to the contrast-setting menu is enabled. 0 -> If access to the contrast-setting menu is disabled.
RESTRICTIONS:	This command is not permissible if a measurement is in progress or the device is in the calibration mode.

ACCess:STATe

DESCRIPTION:	This enables/disables access to the status-display menu.
SYNTAX:	ACCess:STATe <parameter>
PARAMETERS:	1 or ON -> Enables access to the status-display menu. 0 or OFF -> Disables access to the status-display menu.
QUERY FORM:	ACCess:STATe?
RESPONSE:	1 -> If access to the status-display menu is enabled. 0 -> If access to the status-display menu is disabled.
RESTRICTIONS:	This command is not permissible if a measurement is in progress or the device is in the calibration mode.

ACCess:REGister

DESCRIPTION:	This enables/disables access to the spare input/output menu.
SYNTAX:	ACCess:REGister <parameter>
PARAMETERS:	1 or ON -> Enables access to the spare input/output menu. 0 or OFF -> Disables access to the spare input/output menu.
QUERY FORM:	ACCess:REGister?
RESPONSE:	1 -> If access to the spare input/output menu is enabled. 0 -> If access to the spare input/output menu is disabled.
RESTRICTIONS:	This command is not permissible if a measurement is in progress or the device is in the calibration mode.

ACCess:CALibration

DESCRIPTION:	This enables/disables access to the calibration menu.
SYNTAX:	ACCess:CALibration <parameter>
PARAMETERS:	1 or ON -> Enables access to the calibration menu. 0 or OFF -> Disables access to the calibration menu.
QUERY FORM:	ACCess:CALibration?
RESPONSE:	1 -> If access to the calibration menu is enabled. 0 -> If access to the calibration menu is disabled.
RESTRICTIONS:	This command is not permissible if a measurement is in progress or the device is in the calibration mode.

ACCess:DATallogger

DESCRIPTION:	This enables/disables access to the datalogger menu.
SYNTAX:	ACCess:DATallogger <parameter>
PARAMETERS:	1 or ON -> Enables access to the datalogger menu. 0 or OFF -> Disables access to the datalogger menu.
QUERY FORM:	ACCess:DATallogger?
RESPONSE:	1 -> If access to the datalogger menu is enabled. 0 -> If access to the datalogger menu is disabled.
RESTRICTIONS:	This command is not permissible if a measurement is in progress or the device is in the calibration mode.

ACCess:SCALE

DESCRIPTION:	This enables/disables access to the scaling menu.
SYNTAX:	ACCess:SCALE <parameter>
PARAMETERS:	1 or ON -> Enables access to the scaling menu. 0 or OFF -> Disables access to the scaling menu.
QUERY FORM:	ACCess:SCALer?
RESPONSE:	1 -> If access to the scaling menu is enabled. 0 -> If access to the scaling menu is disabled.
RESTRICTIONS:	This command is not permissible if a measurement is in progress or the device is in the calibration mode.

ACCess:DATE

DESCRIPTION:	This enables/disables access to the date/time menu.
SYNTAX:	ACCess:DATE <parameter>
PARAMETERS:	1 or ON -> Enables access to the date/time menu. 0 or OFF -> Disables access to the date/time menu.
QUERY FORM:	ACCess:DATE?
RESPONSE:	1 -> If access to the date/time menu is enabled. 0 -> If access to the date/time menu is disabled.
RESTRICTIONS:	This command is not permissible if a measurement is in progress or the device is in the calibration mode.

ACCess:FAST

DESCRIPTION:	This enables/disables access to the identification menu.
SYNTAX:	ACCess:FAST <parameter>
PARAMETERS:	1 or ON -> Enables access to the identification menu. 0 or OFF -> Disables access to the identification menu. (Quick-Start)
QUERY FORM:	ACCess:FAST?
RESPONSE:	1 -> If access to the identification menu is enabled. 0 -> If access to the identification menu is disabled. (Quick-Start)
RESTRICTIONS:	This command is not permissible if a measurement is in progress or the device is in the calibration mode.

ACCess:LIMit:CONfigure

DESCRIPTION:	This enables/disables access to the comparator-configuration menu.
SYNTAX:	ACCess:LIMit:CONfigure <parameter>
PARAMETERS:	1 or ON -> Enables access to the comparator-configuration menu. 0 or OFF -> Disables access to the comparator-configuration menu.
QUERY FORM:	ACCess:LIMit:CONfigure?
RESPONSE:	1 -> If access to the comparator-configuration menu is enabled. 0 -> If access to the comparator-configuration is disabled.
RESTRICTIONS:	This command is not permissible if a measurement is in progress or the device is in the calibration mode.

ACCess:ENVELOpe:CONfigure

DESCRIPTION:	This enables/disables access to the max./min. measurement function.
SYNTAX:	ACCess:ENVELOpe:CONfigure <parameter>
PARAMETERS:	1 or ON -> Enables access to the max./min. measurement function. 0 or OFF -> Disables access to the max./min. measurement function.
QUERY FORM:	ACCess:ENVELOpe:CONfigure?
RESPONSE:	1 -> If access to the max./min. measurement function is enabled. 0 -> If access to the max./min. measurement function is disabled.
RESTRICTIONS:	This command is not permissible if a measurement is in progress or the device is in the calibration mode.

ACCess:LIMit:EVALuation

DESCRIPTION:	This enables/disables access to the comparator-evaluation menu.
SYNTAX:	ACCess:LIMit:EVALuation <parameter>
PARAMETERS:	1 or ON -> Enables access to the comparator-evaluation menu. 0 or OFF -> Disables access to the comparator-evaluation menu.
QUERY FORM:	ACCess:LIMit:EVALuation?
RESPONSE:	1 -> If access to the comparator-evaluation menu is enabled. 0 -> If access to the comparator-evaluation menu is disabled.
RESTRICTIONS:	This command is not permissible if a measurement is in progress or the device is in the calibration mode.

ACCess:ENVELOpe:EVALuation

DESCRIPTION	This enables/disables access to the max./min. evaluation menu.
SYNTAX:	ACCess:ENVELOpe:EVALuation <parameter>
PARAMETERS:	1 or ON -> Enables access to the max./min. evaluation menu. 0 or OFF -> Disables access to the max./min. evaluation menu.
QUERY FORM:	ACCess:ENVELOpe:EVALuation?
RESPONSE:	1 -> If access to the max./min. evaluation menu is enabled. 0 -> If access to the max./min. evaluation menu is disabled.
RESTRICTIONS:	This command is not permissible if a measurement is in progress or the device is in the calibration mode.

ACCess:MANRange

DESCRIPTION:	This enables/disables access to manual range selection. (From the main menu: RGE [↑] and RGE [↓] keys)
SYNTAX:	ACCess:MANRange <parameter>
PARAMETERS:	1 or ON -> Enables access to manual range selection. 0 or OFF -> Disables access to manual range selection.
QUERY FORM:	ACCess:MANRange?
RESPONSE:	1 -> If access to manual range selection is enabled. 0 -> If access to manual range selection is disabled.
RESTRICTIONS:	This command is not permissible if a measurement is in progress or the device is in the calibration mode.

5.3.14 DATallogger Subsystem

DATallogger:STATe

DESCRIPTION:	This starts/stops the datalogger.
SYNTAX:	DATallogger:STATe <parameter>
PARAMETERS:	1 or ON -> The datalogger is started. 0 or OFF -> The datalogger is stopped.
QUERY FORM:	DATallogger:STATe?
RESPONSE:	1 -> If the datalogger is active. 0 -> If the datalogger is inactive.
RESTRICTIONS:	This command is not permissible if the device is in the calibration mode.

DATallogger:MINimum?

DESCRIPTION:	This calculates and fetches the minimum value of a datalogger block.
SYNTAX:	DATallogger:MINimum? <parameter>
PARAMETERS:	The datalogger block number (0 to 31).
QUERY FORM:	Only query form
RESPONSE:	The minimum value in MOHM, OHM or KOHM.
RESTRICTIONS:	This command is not permissible if a measurement is in progress or the device is in the calibration mode.

DATallogger:MAXimum?

DESCRIPTION:	This calculates and fetches the maximum value of a datalogger block.
SYNTAX:	DATallogger:MAXimum? <parameter>
PARAMETERS:	The datalogger block number (0 to 31).
QUERY FORM:	Only query form
RESPONSE:	The maximum value in MOHM, OHM or KOHM.
RESTRICTIONS:	This command is not permissible if a measurement is in progress or the device is in the calibration mode.

DATallogger:AVERage?

DESCRIPTION:	This calculates and fetches the average value of a datalogger block.
SYNTAX:	DATallogger:AVERage? <parameter>
PARAMETERS:	The datalogger block number (0 to 31).
QUERY FORM:	Only query form
RESPONSE:	The average value in MOHM, OHM or KOHM.
RESTRICTIONS:	This command is not permissible if a measurement is in progress or the device is in the calibration mode.

DATallogger:DEViation?

DESCRIPTION:	This calculates and fetches the standard deviation of a datalogger block.
SYNTAX:	DATallogger:DEViation? <parameter>
PARAMETERS:	The datalogger block number (0 to 31).
QUERY FORM:	Only query form
RESPONSE:	The standard deviation in MOHM, OHM or KOHM.
RESTRICTIONS:	This command is not permissible if a measurement is in progress or the device is in the calibration mode.

DATallogger:COUNT?

DESCRIPTION:	This returns the number of memory locations occupied by a datalogger block and the whole datalogger.
SYNTAX:	DATallogger:COUNT? <parameter>
PARAMETERS:	The datalogger block number (0 to 31).
QUERY FORM:	Only query form
RESPONSE:	Number of memory locations occupied by the datalogger block in question. Without the parameter it returns the free memory Locations of the whole datalogger.
RESTRICTIONS:	This command is not permissible if a measurement is in progress or the device is in the calibration mode.

DATallogger:CLEAr

DESCRIPTION:	This deletes a datalogger block.
SYNTAX:	DATallogger:CLEAr <parameter>
PARAMETERS:	The datalogger block number (0 to 31).
QUERY FORM:	None
RESPONSE:	—
RESTRICTIONS:	This command is not permissible if a measurement is in progress or the device is in the calibration mode.

DATallogger:SELEct:BLOCK

DESCRIPTION:	This selects a datalogger block by its number.
SYNTAX:	DATallogger:SELEct:BLOCK <parameter>
PARAMETERS:	The datalogger block number (0 to 31).
QUERY FORM:	DATallogger:SELEct:BLOCK? <parameter>
RESPONSE:	The number (0 to 31) of the selected datalogger block.
RESTRICTIONS:	This command is not permissible if a measurement is in progress or the device is in the calibration mode.

DATallogger:SElect:NAME

DESCRIPTION:	This selects a datalogger block by its name.
SYNTAX:	DATallogger:SElect:NAME <parameter>
PARAMETERS:	The ID (max. length of 10 characters) of a datalogger block.
QUERY FORM:	DATallogger:SElect:NAME? <parameter>
RESPONSE:	The number (0 to 31) of the selected datalogger block.
RESTRICTIONS:	This command is not permissible if a measurement is in progress or the device is in the calibration mode.

DATallogger:FILTer

DESCRIPTION:	This selects a datalogger filter.
SYNTAX:	DATallogger:FILTer <bl>, <fi>
PARAMETERS:	bl,fi bl: Block number between 0 and 31 fi: One of the following types of filter ALL -> All measurement values are stored. FAIL -> Only invalid measurement values are stored. NOFail -> Only valid measurement values are stored. XVALue -> Every xth measurement value is stored. YTIME -> Storage at a defined time interval. DELTA -> Storage takes place only if the difference to the previously stored value > ΔR.
QUERY FORM:	DATallogger:FILTer? <bl>
RESPONSE:	Filter type of the corresponding datalogger block <bl>. ALL -> All measurement values are stored. FAIL -> Only invalid measurement values are stored. NOFail -> Only valid measurement values are stored. XVALue -> Every xth measurement value is stored. YTIM -> Storage at a defined time interval. DELT -> Storage takes place only if the difference previously stored value > ΔR.
RESTRICTIONS:	This command is not permissible if a measurement is in progress or the device is in the calibration mode.

DATallogger:FILTer:XVALue

DESCRIPTION:	This sets the XVALue filter parameter for a datalogger block. Every xth value is stored in this case.
SYNTAX:	DATallogger:FILTer:XVALue <bl>, <x-Wert>
PARAMETERS:	bl, x-value bl -> Block number between 0 and 31. x-value -> Value between 2 and 9999.
QUERY FORM:	DATallogger:FILTer:XVALue? <bl>
RESPONSE:	The currently selected x-value of the corresponding datalogger block <bl>.
RESTRICTIONS:	This command is not permissible if a measurement is in progress or the device is in the calibration mode.

DATallogger:FILTer:YTIME

DESCRIPTION:	This sets the YTIME filter parameter for a datalogger block. This is the time interval at which measured values are stored.
SYNTAX:	DATallogger:FILTer:YTIME <bl>, <hh>, <mm>, <ss>
PARAMETERS:	bl, hh, mm, ss bl : Block number between 0 and 31. hh: Hours 0 to 90 mm: Minutes 0 to 59 ss: Seconds 0 to 59
QUERY FORM:	DATallogger:FILTer:YTIME? <bl>
RESPONSE:	The selected time interval hh, mm, ss for the corresponding datalogger block <bl>.
RESTRICTIONS:	This command is not permissible if a measurement is in progress or the device is in the calibration mode.

DATallogger:FILTer:DELTA

DESCRIPTION:	This sets the DELTA filter parameter for a datalogger block. A measured value is only stored if the difference to the previous value is larger than DELTA.
SYNTAX:	DATallogger:FILTer:DELTA <bl>, <delta>
PARAMETERS:	bl, delta bl -> Block number between 0 and 31. delta: Delta value between 0.01 MOHM and 200 KOHM
QUERY FORM:	DATallogger:FILTer:DELTA? <bl>
RESPONSE:	The currently selected delta value for the corresponding datalogger block <bl>.
RESTRICTIONS:	This command is not permissible if a measurement is in progress or the device is in the calibration mode.

DATallogger:STATE:NAME?

DESCRIPTION:	This returns the name/ID related to a datalogger block number.
SYNTAX:	DATallogger:STATE.NAME? <bl>
PARAMETERS:	bl: Block number between 0 and 31.
QUERY FORM:	Only query form
RESPONSE:	The ID (max. length of 10 characters) of datalogger block number <bl>.
RESTRICTIONS:	This command is not permissible if a measurement is in progress or the device is in the calibration mode.

DATallogger:STATE:DEFine

DESCRIPTION:	This assigns a name/ID to the datalogger block with the selected number. The query form returns the name (ID) of the corresponding block number.
SYNTAX:	DATallogger:STATE.DEFine <name>, <bl>
PARAMETERS:	name: ID (max. length of 10 characters) of the datalogger block. bl: Number of the datalogger block, 0 to 31.
QUERY FORM:	DATallogger:STATE.DEFine? <name>
RESPONSE:	The number of the datalogger block with the corresponding name (ID).
RESTRICTIONS:	This command is not permissible if a measurement is in progress or the device is in the calibration mode.

DATallogger:DATA:FRESistance?

DESCRIPTION:	This retrieves a measured value stored in a datalogger block.
SYNTAX:	DATallogger:DATA:FRESistance? <bl>, <num>
PARAMETERS:	bl: Block number 0 to 31, num: Number of the measured value in the block (num >=1)
QUERY FORM:	Only query form
RESPONSE:	Stored resistance value
RESTRICTIONS:	This command is not permissible if a measurement is in progress or the device is in the calibration mode.

DA? (short form)

DESCRIPTION:	This retrieves 20 measurement values stored in a datalogger block.
SYNTAX:	DA? <bl>, <num>
PARAMETERS:	bl: Block number 0 to 31 num: Number of the measurement value in the block (num >=1)
QUERY FORM:	Only query form
RESPONSE:	20 consecutive measurement values, starting with the value at memory location <num>.
RESTRICTIONS:	This command is not permissible if a measurement is in progress or the device is in the calibration mode.

DATallogger:DATA:DATE?

DESCRIPTION:	This retrieves the storage date of a measurement value.
SYNTAX:	DATallogger:DATA:DATE? <bl>, <num>
PARAMETERS:	bl: Block number 0 to 31 num: Number of the measurement value in the block (num >=1)
QUERY FORM:	Only query form
RESPONSE:	The storage date of the selected resistance value (dd, mm, yyyy)
RESTRICTIONS:	This command is not permissible if a measurement is in progress or the device is in the calibration mode.

DATallogger:DATA:TIME?

DESCRIPTION:	This retrieves the storage time of a measurement value.
SYNTAX:	DATallogger:DATA:TIME? <bl>, <num>
PARAMETERS:	bl: Block number 0 to 31 num: Number of the measurement value in the block (num >=1)
QUERY FORM:	Only query form
RESPONSE:	The storage time of the selected resistance value. (hh, mm, ss, xx) xx -> 1/100 seconds
RESTRICTIONS:	This command is not permissible if a measurement is in progress or the device is in the calibration mode.

DATallogger:DATA:ALL?

DESCRIPTION:	This retrieves a stored measurement value together with the corresponding date and time.
SYNTAX:	DATallogger:DATA:ALL? <bl>, <num>
PARAMETERS:	bl: Block number 0 to 31 num: Number of the measurement value in the block (num >=1)
QUERY FORM:	Only query form
RESPONSE:	The stored measurement value together with the corresponding date and time. Measurement value, date, time. Meas. value: Resistance value with unit Date: dd, mm, yyyy Time: hh, mm, ss, xx (xx -> 1/100 seconds)
RESTRICTIONS:	This command is not permissible if a measurement is in progress or the device is in the calibration mode.

DV? (short form)

DESCRIPTION:	This retrieves 7 stored measurement values together with the corresponding dates and times.
SYNTAX:	DV? <bl>, <num>
PARAMETERS:	bl: Block number 0 to 31 num: Number of the measurement value in the block (num >=1)
QUERY FORM:	Only query form
RESPONSE:	7 consecutive measurement values together with the corresponding dates and times of storage. The first value refers to the memory location. Measurement value, date, time. Meas. value: Resistance value with unit Date: dd, mm, yyyy Time: hh, mm, ss, xx (xx -> 1/100 seconds)
RESTRICTIONS:	This command is not permissible if a measurement is in progress or the device is in the calibration mode.

DATallogger:SIZE

DESCRIPTION:	This specifies the size of a datalogger block.
SYNTAX:	DATallogger:SIZE <bl>, <size>
PARAMETERS:	bl: Block number 0 to 31 size: Size of the datalogger block
QUERY FORM:	DATallogger:SIZE? <bl>
RESPONSE:	The size of the datalogger block with the number <bl>.
RESTRICTIONS:	This command is not permissible if a measurement is in progress or the device is in the calibration mode.

6.3.15 IEEE488.2 commands

*CLS

DESCRIPTION:	The device is set to the Operation-Complete-Idle state. The device is set to the Operation-Query-Complete-Idle state. The error buffer is deleted. The Operation-Event-Status-Register is reset. The Questionable-Event-Status-Register is reset. The Status Byte is reset.
SYNTAX:	*CLS
PARAMETERS:	None
QUERY FORM:	None
RESPONSE:	—
RESTRICTIONS:	None

*ESE

DESCRIPTION:	The Standard-Event-Status-Enable-Register is set.
SYNTAX:	*ESE <parameter>
PARAMETERS:	A value between 0 and 255. The decimal value corresponds to the bit combination of the 8-bit register.
QUERY FORM:	ESE?
RESPONSE:	The current setting mask of the Standard-Event-Enable-Register is returned.
RESTRICTIONS:	None

**ESR

DESCRIPTION:	The Standard-Event-Status-Register is read out and then reset.
SYNTAX:	*ESR
PARAMETERS:	None
QUERY FORM:	Only query form
RESPONSE:	A decimal value between 0 and 255 is returned, in accordance with the contents of the register.
RESTRICTIONS:	None

*IDN?

DESCRIPTION:	This requests the ID of the device. - Company name - Device name - Serial number - Device version (SW version) - Calibration status
SYNTAX:	*IDN?
PARAMETERS:	None
QUERY FORM:	Only query form
RESPONSE:	BURSTER, RESISTOMAT 2329, SNsssssss, Vxxxx, Cyyyy
RESTRICTIONS:	None

*OPC

DESCRIPTION:	The device is set to the Operation-Complete-Active state (OCAS). In the OCAS, the Operation-Complete bit in the Standard-Event-Register is set when an operation is completed.
SYNTAX:	*OPC
PARAMETERS:	None
QUERY FORM:	The query form of the command has a different function. For this reason, the query form is described separately.
RESPONSE:	—
RESTRICTIONS:	None

*OPC?

DESCRIPTION:	The device is set to the Operation-Complete-Active state (OCAS). In the OCAS, the device writes a 1 to the output buffer following the execution of a command.
SYNTAX:	*OPC?
PARAMETERS:	None
QUERY FORM:	Only query form. The same command without a query form has a different function and is described separately.
RESPONSE:	1, following execution of the command.
RESTRICTIONS:	None

*RST

DESCRIPTION:	The device is set to a defined initial state. The interface settings remain unchanged, and the device stays in the remote mode.
SYNTAX:	*RST
PARAMETERS:	None
QUERY FORM:	None
RESPONSE:	—
RESTRICTIONS:	None

*SRE

DESCRIPTION:	The Service-Request-Enable-Register is set.
SYNTAX:	*SRE <parameter>
PARAMETERS:	A decimal value between 0 and 255, corresponding to the bit combination of the 8-bit register.
QUERY FORM:	*SRE?
RESPONSE:	The present setting mask of the Service-Request-Enable-Register.
RESTRICTIONS:	None

*STB?

DESCRIPTION:	The Status Byte is read out (a 488.2 register mit 8 summary bits)
SYNTAX:	*STB?
PARAMETERS:	None
QUERY FORM:	Only query form
RESPONSE:	A decimal value between 0 and 255, corresponding to the present contents of the 8-bit register.
RESTRICTIONS:	None

*TST?

DESCRIPTION:	Self-test query command. This command is recognized by the device, but has no additional function.
SYNTAX:	*TST?
PARAMETERS:	None
QUERY FORM:	None
RESPONSE:	A 1 is returned.
RESTRICTIONS:	None

*WAI

DESCRIPTION:	This command sets a device so that all other commands are processed sequentially. This command does not have a function in the case of the RESISTOMAT® 2329, as commands are always processed sequentially by this device. Thus, the command is simply recognized by the RESISTOMAT® 2329.
SYNTAX:	*WAI
PARAMETERS:	None
QUERY FORM:	None
RESPONSE:	—
RESTRICTIONS:	None

*SAV

DESCRIPTION:	This stores a device setting. Up to 32 settings can be stored.
SYNTAX:	*SAV <parameter>
PARAMETERS:	A number between 0 and 31.
QUERY FORM:	None
RESPONSE:	—
RESTRICTIONS:	None

*RCL

DESCRIPTION:	A stored device setting is loaded. 33 different settings can be loaded (0-32). 32 is the default setting.
SYNTAX:	*RCL <parameter>
PARAMETERS:	A number between 0 and 32. 32 is the default setting.
QUERY FORM:	None
RESPONSE:	—
RESTRICTIONS:	None

6.4. Status Register

6.4.1 Standard Event Status Register

Bits used	Meaning
Bit 0 Operation Complete	This bit is set in response to the *OPC command. It indicates that the previous command has been executed.
Bit 2 Query Error	This bit indicates that either 1. Data were requested although none are present, or 2. Data in the output buffer were lost.
Bit 3 Device Dependent Error	If an internal device error has occurred.
Bit 4 Execution Error	An error has occurred during execution of an SCPI command.
Bit 5 Command Error	An SCPI command was not recognized by the interpreter.

6.4.2 Questionable Status Register

Bits used	Meaning
Bit 4 TEMPerature	Problem during temperature measurement
Bit 8 CALibration	Error during calibration
Bit 9 FRESistor	Error during resistance measurement

6.4.3 Operation Status Register

Bits used	Meaning
Bit 0 CALibration	The device is in the calibration mode
Bit 2 RANGing	The device is changing ranges
Bit 4 MEASuring	A measurement is in progress
Bit 8 VALue available	A measured value is available

6.5. Sample programs

The two sample programs for the RS232 interface (standard device) and the IEEE488 interface can also be called up on the Internet, at

www.burster.de

6:5.1 Sample program for the RS232 interface

```

**      File Name:          2329_rs.bas                      Version: 1.0
**
**      Developed by:      C.Speck             on 03.12.1996
**      Changed by:       M.Westermann        on 26.03.1997
**
**      Language:         QBASIC 4.5 Operating system:      MS-DOS 6.22
**
**      Description:      Sample program for 2329-RS232
**
**      Remarks:
**
**      Copyright by burster präzisionsmesstechnik, Gernsbach 07224-6450
*****
'Declaration of the functions used
DECLARE FUNCTION CmdSenden (cmd$)           Send command
DECLARE SUB CmdEmpfangen (antwort$)        'Receive response from device
DECLARE FUNCTION AbfrageSOC ()             'Request Status Operation Condition Register
DIM antwort$(100)
DIM befehl$(100)

OPEN "COM1:9600,N,8,1" FOR RANDOM AS #3 'INITIALIZE RS232
CLS 'CLEAR SCREEN
PRINT "DEMOPROGRAMM"
PRINT burster RESISTOMAT® Typ 2329"
PRINT "Control via the RS232 interface, COM1 9600 baud"
PRINT "Transfer protocol: ANSI X3.28 A3"
PRINT
PRINT "The measurement is started. Press the space bar to cancel it."
PRINT

befehl$ = "abort" 'Stop the device if a measurement is in progress
IF (CmdSenden(id2329%, befehl$) = 0) THEN
    SYSTEM
END IF

i = 0 'Reset the counter
DO WHILE (INKEY$ = "") 'Request measurement values until the space bar is pressed
    befehl$ = "in" 'Start a measurement
    IF (CmdSenden(befehl$) = 0) THEN
        SYSTEM
    END IF
'In the next loop, the device waits until a bit in the Operation-Status-Register
'is set to indicate that a measurement variable is available
done% = 0

```

```

DO WHILE (done% <> 1)
  done% = AbfrageSOC 'Scan the Status Operation Condition Register
  IF (done% = -1) THEN 'Abort in the event of an error
    SYSTEM
  END IF
  LOOP

  befehl$ = "fe?" 'Fetch a measurement value
  IF (CmdSenden(befehl$) = 0) THEN
    SYSTEM
  END IF

  CALL CmdEmpfangen(antwort$ 'Fetch a measurement value
  LOCATE 15, 3
  PRINT i, "Resistance value:", antwort$ 'Display the measurement value
  i = i + 1
  LOOP
END

```

```

FUNCTION AbfrageSOC
*****
'Scan the Status Operation Condition Register
*****
  DIM befehl$(100)
  DIM stri$(100)
  REM Special characters are defined here
  STX$ = CHR$(2)
  ETX$ = CHR$(3)
  EOT$ = CHR$(4)
  ENQ$ = CHR$(5)
  ACK$ = CHR$(6)
  NAK$ = CHR$(21)
  LF$ = CHR$(10)

  befehl$ = "s:o:c?" 'Scan the Status Operation Condition Register
  IF (CmdSenden(befehl$) = 0) THEN
    SYSTEM
  END IF
  CALL CmdEmpfangen(antwort$) 'Scan the Status Operation Condition Register
  stat = VAL(antwort$ 'Convert to integer form
  stat = stat AND 256 'End of measurement, clear bit
  IF stat <> 256 THEN 'If not end of measurement
    AbfrageSOC = 0 'Continue waiting
  ELSE
    AbfrageSOC = 1 'Measurement value is present
  END IF
END FUNCTION

```

```

SUB CmdEmpfangen (antwort$)
*****
'Receive response from 2329
*****
  DIM stri$(100)
  DIM ant$(100)
  REM Special characters are defined here
  STX$ = CHR$(2)
  ETX$ = CHR$(3)

```

```

EOT$ = CHR$(4)
ACK$ = CHR$(6)
NAK$ = CHR$(21)
LF$ = CHR$(10)

```

```

PRINT #3, EOT$           'Switch device to master mode
StartEmpfang:
ant$ = " "               'Delete response string
stri$ = " "              'Delete measurement-value string
ant$ = INPUT$(1, #3)
WHILE (ant$ <> ETX$) AND (ant$ <> EOT$) 'While ETX or EOT is not received
IF ant$ >= CHR$(32) THEN 'If no special characters are present
    stri$ = stri$ + ant$ 'Form Status String
END IF
ant$ = INPUT$(1, #3)     'Read in character from RS232
WEND
IF (ant$ = EOT$) THEN   'If EOT is received
    EXIT SUB            'End Sub
ELSE
    antwort$ = stri$    'Save response
    PRINT #3, ACK$     'Acknowledge
    GOTO StartEmpfang  'Read in again until EOT is received
END IF
END SUB

```

```

FUNCTION CmdSenden (cmd$)

```

```

*****
'Send command to 2329
*****
    DIM ant$(100)
    DIM msg$(100)
    REM    Special characters are defined here
    STX$ = CHR$(2)
    ETX$ = CHR$(3)
    EOT$ = CHR$(4)
    ACK$ = CHR$(6)
    NAK$ = CHR$(21)
    LF$ = CHR$(10)

    msg$ = STX$ + cmd$ + LF$ + ETX$ 'Formulate command
    PRINT #3, msg$                  'Send command
    'Wait for acknowledgement
    ant$ = " "                       'Delete response string
    ant$ = INPUT$(1, #3)             'Read in response
    IF (ant$ <> ACK$) THEN           'If not ACK
        PRINT "Gerät antwortet mit NAK" " 'Display error message
        CmdSenden = 0               'Error during transmission
    ELSE
        CmdSenden = 1               'Transmission OK
    END IF                           'End of If statement
END FUNCTION

```

6.5.2 Sample program for the IEEE488 interface

```

*****
* File Name:      2329_iec.bas   Version: 1.0
*
* Developed by:   M.Westermann   on 26.03.1997
* Changed by:    on dd.mm.yyyy
*
* Language:      QBASIC 4.5 Operating system:          MS-DOS 6.22
*
* Description:   Sample program for the 2329-IEEE488
*
* Note: To load the IEEE488 bus driver library, call up the
*       QB45 basic in a Batch file as follows:
*       "qb 2329_iec.bas /L c:\AT-GPIB\QBASIC\QBIB.QLB"
*       The creation of the QBIB.QLB is described in the Readme file
*       accompanying the IEEE card.
*       The AT-GPIB/TNT made by National Instruments is used
*       in this example.
*
* Copyright by burster präzisionsmesstechnik, Gernsbach 07224-6450
*****

'Declaration of the functions used
DECLARE FUNCTION CmdSenden (id2329%, CMD$)          'Send command
DECLARE FUNCTION CmdEmpfangen (id2329%, antwort$)
DECLARE FUNCTION AbfrageSRQ (id2329%) "Request Status Operation Condition Register
DECLARE FUNCTION LeseOperEventReg (id2329%)
DECLARE FUNCTION LeseQuestReg (id2329%)
DECLARE FUNCTION LeseQuestFresReg (id2329%)
DECLARE SUB gpiberr (msg$)

'Include file for the IEEE card
'$INCLUDE: 'd:\at-gpib\qbasic\qbdecl.bas'

'Definition of the masks for register scanning
CONST EOC = &H100          'Bit 8 of the Operation Status Register
CONST FRESError = &H200   'Bit 9 of the Questionable Status Register
CONST TEMPErrror = &H10   'Bit 4 of the Questionable Status Register
CONST SRQOperReg = &H80   'Bit 7 of the SRQ Register
CONST SRQQuestReg = &H8   'Bit 3 of the SRQ Register

CLS                          'Clear screen
PRINT "DEMOPROGRAMM          "
PRINT "burster RESISTOMAT® Model 2329      "
PRINT "Control via IEC bus interface"
PRINT
INPUT "Enter the IEEE488 address of the RESISTOMAT® Model 2329:", adr
PRINT
PRINT "Measurement started. Press space bar to cancel"
PRINT

```

'The next command is a 488.2 command. It receives the
'device address and the timeout as parameters.

'The device handle (id2329) returned.

CALL IBDEV (0, adr, 0, T10s, 1, 0, id2329%)

IF (id2329% < 0) THEN 'In the event of an error, invoke the error routine

CALL gpiberr ("ibdev Error)

SYSTEM

END IF

'The following commands are used to set the masks for the required

'SRQ function for the different registers

'Enable BIT8 = EOC as a mask in the Status-Operation-Enable-Register

befehl\$ = "stat:oper:enab " + STR\$(EOC)

IF (CmdSenden(id2329%, befeh1\$) = 0) THEN

SYSTEM

END IF

'Enable temperature and resistance errors

'In the Status-Questionable-Enable-Register, enable BIT4 (= error) for

'temperature measurement and BIT9 (= error) for resistance measurement

befehl\$ = "stat:ques:enab " + STR\$(TEMPError OR FRESError)

IF (CmdSenden(id2329%, befeh1\$) = 0) THEN

SYSTEM

END IF

'In the Service-Request-Enable-Register, enable BIT3 (= Questionable-Register

'input) and BIT7 (= Operation-Register input) for an SRQ

befehl\$ = "*sre " + STR\$(SRQOperReg OR SRQQuestReg)

IF (CmdSenden(id2329%, befeh1\$) = 0) THEN

SYSTEM

END IF

befehl\$ = "abort" 'Stop the device if a measurement is in progress

IF (CmdSenden(id2329%, befeh1\$) = 0) THEN

SYSTEM

END IF

befehl\$ = "init:cont 0" 'Switch the device to single measurement

IF (CmdSenden(id2329%, befeh1\$) = 0) THEN

SYSTEM

END IF

i = 0 'Reset the counter

DO WHILE (INKEY\$ = " ") 'Request the measurement values until the space bar is pressed

befehl\$ = "in" 'Start a measurement

IF (CmdSenden(id2329%, befeh1\$) = 0) THEN 'Send command

SYSTEM

END IF

'In the next loop, the device waits until an SRQ is present

'After that, the measurement value is fetched

done% = 0

DO WHILE (done% <> 1)

done% = AbfrageSRQ(id2329%) 'Scan the SRQ register

IF (done% = -1) THEN'im 'Abort in the event of an error

SYSTEM

END IF

LOOP

```

befehl$ = "fe?"          'Fetch measurement value
IF (CmdSenden(id2329%, befehl$) = 0) THEN 'Send command

antwort$ = SPACE$(12)   'Pre-assign buffer
IF (CmdEmpfangen(id2329%, antwort$) = 1) THEN 'Fetch measurement value
    REM LOCATE 15, 3
    PRINT i; " Widerstandswert: "; antwort$ 'Display measurement value
    i = i + 1
ELSE
    SYSTEM
END IF
LOOP
END

```

FUNCTION AbfrageSRQ (id2329%)

```

*****
'This function waits for an SRQ on the IEC bus and then invokes
'the service function for the RESISTOMAT®
*****

    DIM befehl$(100)
    DIM stri$(100)

    MASK% = &H4800          'set RQS+TIMO as ibwait mask
    CALL IBWAIT(id2329%, MASK)
    IF (IBSTA% AND EERR) THEN
        CALL gpiberr("ibwait Error")
        EXIT FUNCTION
    END IF
    CALL IBRSP(id2329%, SPR%) 'Spoll request byte
    IF (IBSTA% AND EERR) THEN 'Invoke error routine in the event of an error
        AbfrageSRQ = -1      'Note error
        CALL gpiberr("ibwait Error")
        EXIT FUNCTION
    END IF

    SELECT CASE SPR%        'Branch after Spoll Byte
        CASE 192
            AbfrageSRQ = 1          'Everything OK
            'Scan and delete the Operation Event Register
            status = LeseOperEventReg(id2329%)
        CASE 72, 200        'An error has occurred
            AbfrageSRQ = -1        'Note the error
            'The following registers must be read out and deleted
            status = LeseOperEventReg(id2329%)
            IF (status > 0) THEN
                PRINT "Device error: Operation Event Register = "; status
            END IF
            status = LeseQuestReg(id2329%)
            IF (status > 0) THEN
                PRINT "Device error: Questionable Register = "; status
            END IF

            status = LeseQuestFresReg(id2329%)
            IF (status > 0) THEN
                PRINT "Device error: Questionable FRes Register = "; status
            END IF

```



```

CASE ELSE
    AbfrageSRQ = 0                'Continue waiting for SRQ
END SELECT

END FUNCTION

FUNCTION CmdEmpfangen (id2329%, antwort$)
*****
'Receive response from 2329
*****
    DIM help$(100)

    CALL IBRD(id2329%, antwort$)    'Fetch string from IEC-BUS
    IF (IBSTA% AND EERR) THEN
        CALL gpiberr("ibrd Error")
        antwort$ = " "
        CmdEmpfangen = 0            'An error has occurred
    ELSE
        L = LEN(antwort$)
        help$ = MID$(antwort$, 1, L - 1)    'Discard LF character
        antwort$ = help$
        CmdEmpfangen = 1            'Everything OK
    END IF
END FUNCTION

FUNCTION CmdSenden (id2329%, CMD$)
*****
'Send command to 2329
*****
    DIM msg$(100)

    REM LF$ = CHR$(10)

    msg$ = CMD$ + CHR$(10)        'Formulate command

    CALL IBWRT(id2329%, msg$)     'Send command via IEC bus
    IF (IBSTA% AND EERR) THEN
        CALL gpiberr("ibwrt Error")
        CmdSenden = 0            'Error during transmission
    ELSE
        CmdSenden = 1            'Transmission OK
    END IF
END FUNCTION

REM DEFDBL A-Z
SUB gpiberr (msg$) STATIC
'This function is taken from the Basic example accompanying the National Instruments card
'=====
    Subroutine GPIBERR
'This subroutine will notify you that a NI-488 function failed by printing
'an error message. The status variable IBSTA% will also be printed
'in hexadecimal along with the mnemonic meaning of the bit position.
'The status variable IBERR% will be printed in decimal along with the
'mnemonic meaning of the decimal value. The status variable IBCNT% will
'be printed in decimal.
'The NI-488 function IBONL is called to disable the hardware and software.
'
'The STOP command will terminate this program.
'=====

```

```

PRINT msg$
PRINT "ibsta = &H"; HEX$(IBSTA%); " <";
IF IBSTA% AND EERR THEN PRINT " ERR";
IF IBSTA% AND TIMO THEN PRINT " TIMO";
IF IBSTA% AND EEND THEN PRINT " END";
IF IBSTA% AND SRQI THEN PRINT " SRQI";
IF IBSTA% AND RQS THEN PRINT " RQS";
IF IBSTA% AND SPOLL THEN PRINT " SPOLL";
IF IBSTA% AND EEVENT THEN PRINT " EVENT";
IF IBSTA% AND CMPL THEN PRINT " CMPL";
IF IBSTA% AND LOK THEN PRINT " LOK";
IF IBSTA% AND RREM THEN PRINT " REM";
IF IBSTA% AND CIC THEN PRINT " CIC";
IF IBSTA% AND AATN THEN PRINT " ATN";
IF IBSTA% AND TACS THEN PRINT " TACS";
IF IBSTA% AND LACS THEN PRINT " LACS";
IF IBSTA% AND DTAS THEN PRINT " DTAS";
IF IBSTA% AND DCAS THEN PRINT " DCAS";
PRINT " >"

PRINT "iberr = "; IBERR%;
IF IBERR% = EDVR THEN PRINT " EDVR <DOS Error>"
IF IBERR% = ECIC THEN PRINT " ECIC <Not CIC>"
IF IBERR% = ENOL THEN PRINT " ENOL <No Listener>"
IF IBERR% = EADR THEN PRINT " EADR <Address error>"
IF IBERR% = EARG THEN PRINT " EARG <Invalid argument>"
IF IBERR% = ESAC THEN PRINT " ESAC <Not Sys Ctrlr>"
IF IBERR% = EABO THEN PRINT " EABO <Op. aborted>"
IF IBERR% = ENEB THEN PRINT " ENEB <No GPIB board>"
IF IBERR% = EOIP THEN PRINT " EOIP <Async I/O in prg>"
IF IBERR% = ECAP THEN PRINT " ECAP <No capability>"
IF IBERR% = EFSO THEN PRINT " EFSO <File sys. error>"
IF IBERR% = EBUS THEN PRINT " EBUS <Command error>"
IF IBERR% = ESTB THEN PRINT " ESTB <Status byte lost>"
IF IBERR% = ESRQ THEN PRINT " ESRQ <SRQ stuck on>"
IF IBERR% = ETAB THEN PRINT " ETAB <Table Overflow>"

PRINT "ibcnt = "; IBCNT%

```

END SUB

FUNCTION LeseOperEventReg (id2329%)

‘Read out Operation Event Register

DIM befehl\$(50)

befehl\$ = "stat:oper?" ‘Scan register

IF (CmdSenden(id2329%, befehl\$) = 0) THEN
SYSTEM

END IF

antwort\$ = SPACE\$(5) ‘Pre-assign buffer

IF (CmdEmpfangen(id2329%, antwort\$) = 0) THEN ‘Fetch register contents
SYSTEM

END IF

LeseOperEventReg = VAL(antwort\$) ‘Return value

END FUNCTION

```

antwort$ = SPACE$(5)           'Pre-assign buffer
  IF (CmdEmpfangen(id2329%, antwort$) = 0) THEN           'Fetch register contents
    SYSTEM
  END IF
  LeseOperEventReg = VAL(antwort$) 'Return value
END FUNCTION

```

```

FUNCTION LeseQuestFresReg (id2329%)

```

```

*****

```

```

'Read out Questionable Fres Register

```

```

*****

```

```

  DIM befehl$(50)

```

```

  befehl$ = "stat:ques:fres?"           'Scan register

```

```

  IF (CmdSenden(id2329%, befehl$) = 0) THEN
    SYSTEM

```

```

  END IF

```

```

  antwort$ = SPACE$(4)           'Pre-assign buffer

```

```

  IF (CmdEmpfangen(id2329%, antwort$) = 0) THEN           'Fetch register contents
    SYSTEM

```

```

  END IF

```

```

  LeseQuestFresReg = VAL(antwort$) 'Return value

```

```

END FUNCTION

```

```

FUNCTION LeseQuestReg (id2329%)

```

```

*****

```

```

'Read out Questionable Fres Register

```

```

*****

```

```

  DIM befehl$(50)

```

```

  befehl$ = "stat:ques?"           'Scan register

```

```

  IF (CmdSenden(id2329%, befehl$) = 0) THEN
    SYSTEM

```

```

  END IF

```

```

  antwort$ = SPACE$(4)           'Pre-assign buffer

```

```

  IF (CmdEmpfangen(id2329%, antwort$) = 0) THEN           'Fetch register contents
    SYSTEM

```

```

  END IF

```

```

  LeseQuestReg = VAL(antwort$)       'Return value

```

```

END FUNCTION

```

6.6. Error status display

6.6.1 Error status display in the error status field

In the event of an error, a corresponding error status appears in status line 2 (page 27) of the display field S. 2.2.

Hexadecimal display

↓	-	MI-Over:	Measurement current too high (in the 20-mV mode) or test-object resistance / line resistance too high.	
2	-	MU-Over:	Measuring amplifier for the potential taps is (+U, -U) overdriven.	
4	-	I-Over: I-cable breakage	Test-object resistance / line resistance too high. e.g. I-cable breakage, or resistance too high in the 20-mV mode.	
8	-	Overdrive:	Drive limits of the internal A/D converter have been exceeded.	} ^{18_{hex}} The 15 V supply voltage is missing
10	-	Underdrive:	Drive limits of the internal A/D converter have been fallen short of.	
20	-	I not constant:	Measurement current has not settled; this can occur in the case of inductive test objects. The test object might not be measurable, due to an excessively high inductance or time constant $T = \sqrt{\frac{L}{R}}$.	
40	-	U-cable breakage:	+ U, -U-line resistance too high, or no contact with the test object.	
80	-	Temperatur compensation:	Error in temperature compensation, check external sensor.	

Different combinations can appear in the hexadecimal display. For example:

22	-	(20+2)	Measurement current has not settled, as the inductance of the test object might be too high, and the measurement amplifier of the potential taps (+U,-U) is overdriven.
A	-	(2+8)	The measurement amplifier for the potential taps is overdriven and the drive limits of the internal A/D converter have been exceeded.
18	-	(10+8)	In the case of overdrive or underdrive, the voltage supply in the measurement section is not OK.

6.6.2 Error status display in the temperature display field

If 80_{hex} appears in the error status field S. 2.2 (page 27), the temperature display field S. 1.3 (page 27) also indicates a hexadecimal number which can be used to evaluate the error.

The following errors can be displayed:

Hexadecimal display

- | | | |
|--------------------------------|--------------------------------------------------------|---------------------------------------------------------------------------------------------------------------------------------|
| <p>↓</p> <p>1 -</p> <p>2 -</p> | <p>} Cable breakage:
or no Pt100
connected</p> | <p>The measurement line for the Pt100 sensor is interrupted or has an excessively high impedance, or no Pt100 is connected.</p> |
| <p>4 -</p> | <p>U-cable breakage:</p> | <p>The potential taps (+U, -U) are interrupted, or the line resistance is too high.</p> |
| <p>8 -</p> | <p>Cable breakage:
or no Pt100
connected</p> | <p>The measurement line for the Pt100 sensor is interrupted or has an excessively high impedance, or no Pt100 is connected.</p> |
| <p>10 -</p> | <p>Invalid resistance:</p> | <p>The Pt100 might be reverse-connected.</p> |
| <p>20 -</p> | <p>Invalid temperature:</p> | <p>The temperature lies outside the defined range or cannot be calculated.</p> |
| <p>40 -</p> | <p>15 V power supply:</p> | <p>The ± 15 V power supply inside the device is not OK.</p> |

As in the error status field, different combinations can also appear in the temperature display field.

6.6.3 Calibration Error

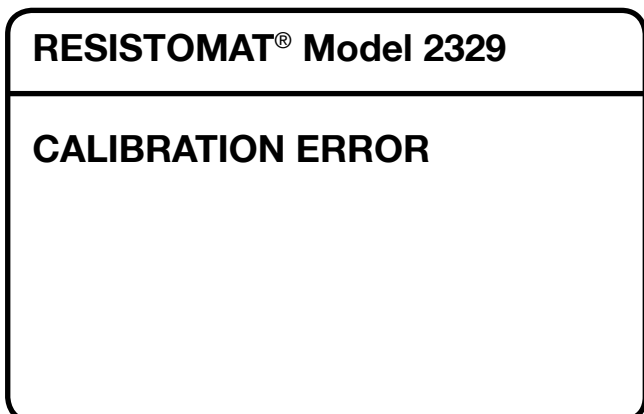

The announcement "Calibration Error" appears on the display when the calibration data are lost (e.g. when the internal battery is defect).

You can not work with the device any longer because all functions are locked.

In this case please send the Ohmmeter to our service dept.

7. Maintenance and Customer Service

7.1 Maintenance

The RESISTOMAT® Model 2329 does not require any maintenance by the user. Repairs which might be required must only be performed by the manufacturer.

7.2 Customer Service

Enquiries:

Please indicate the serial number of your device when sending technical enquiries to the manufacturer. This will make it possible to identify the hardware and software versions and allow rapid remedy. The serial number is indicated on the type plate.

Shipping notes:

When sending the RESISTOMAT® model 2329 to the manufacturer for repair, please observe the following packaging and shipping guidelines:

Prepare a note briefly describing the fault and attach it to the housing of the device.

Adding your name and department as well as a phone and fax number to this information will help us process your complaint more quickly.

burster präzisionsmesstechnik gmbh & co kg

Talstraße 1-5	76593 Gernsbach	Germany
P.O. Box 1432	76587 Gernsbach	Germany
Tel.: +49 7224/645-0	Fax: +49 7224/645-88	
E-Mail:	info@burster.com	
	www.burster.com	

7.3 Manufacturer's guarantee

burster guarantees the reliable operation of the device for a period of 12 months following its delivery.

Repairs required within this period will be performed free-of-charge.

This guarantee does not cover damage arising from improper handling of the device.

Furthermore, the manufacturer cannot be held liable for any type of consequential damage.

Technical data are subject to change without notice.

7.4 Cleaning the device

To clean the front panel and housing of the device, only use water-soluble detergent, not benzene.

8. Technical Data

Only values with tolerances or limits can be taken as guaranteed. Values without tolerances serve purely as orientation and are not binding.

The RESISTOMAT® model 2329 is easy to maintain and has a robust metal housing. The individual modules can be accessed and serviced with the greatest of ease.

All the control elements are clearly arranged clearly on the front panel. The connection socket for the test object, as well as the inputs and outputs for the interface, comparator, Pt100 sensor for temperature compensation and the control unit are located on the rear of the device.

Measuring range	Resolution	Measuring current
200.00 mΩ	10 μΩ	100 mA
2.0000 Ω	100 μΩ	10 mA
20.000 Ω	1 mΩ	10 mA
200.00 Ω	10 mΩ	1 mA
2.0000 kΩ	100 mΩ	1 mA
20.000 kΩ	1 Ω	100 μA
200.00 kΩ	10 Ω	10 μA

Measurement error (with temperature compensation inactive): up to 0.03 % ± 2 digits
 This error is valid for a load voltage up to 0.5 V.
 At higher load voltages the error increase 0.02 %/V.

Starting time: < 10 min. to attain the error limits

Max. voltage across the open terminals: ≤ 16 V

Measurement connection: 4-wire technique for current-voltage measurement (Kelvin), ungrounded circuit, potential binding on the test object or the RESISTOMAT®, as required.

Max. load voltage: ≥ 5 V

Measurement time: Up to 50 measurements and evaluations per second, depending on the resolution and the measurement mode in the case of purely ohmic test objects.

Measurement types: Continuous and single measurement

Range selection: Manual, automatic or via interface

Dry-circuit measurement: According to DIN IEC 512 Part 2
 20 mV load voltage limit up to 4 Ω

Temperature compensation: 10 different, individually adjustable temperature coefficients;
 individually adjustable reference temperature display (e.g. 20 °C).

Temperature recording: Via an external Pt100 sensor or transmitter (e.g. pyrometer)
 with a voltage (0...10 V) or current output (0...20 mA) or (4.... 20 mA)

Comparator: 2 or 4 limiting values

Relay outputs: One switching contact each for evaluation results <<, <, =, >, >>
 Switching power 30 W
 Voltage capacity max. 48 V
 Current capacity max. 1 A
 or via PLC outputs for current-consuming inputs

PLC outputs: $U_{\min} = 15 \text{ V}$ $U_{\max} = 30 \text{ V}$ $I_{\max} = 150 \text{ mA}$ per output
 (max. 600 mA for all outputs together)

Datalogger: The datalogger has a memory capacity of 20 000 measured values which can be subdivided into blocks

General data

Display:	128 x 64 pixel, transfective LCD graphic display with individually adjustable contrast and background illumination.
Display of measurement values:	3 1/2 or 4 1/2 digit as required, 15 mm high, Indication: absolute, Δ% or evaluation >>, >, =, <, <<
Power supply:	230 V ± 10 % or 115 V ± 10 % via a mains voltage selector
Mains frequency:	47 - 63 Hz
Power consumption:	max. 25 VA
Ambient temperature:	Operation +5 ... 23 ... 50 °C, Storage -10 ... 60 °C
Potential binding:	Internally grounded measurement section, switchable to external grounding
Time, datalogger and device settings:	These data are backed up by an internal battery
Parameter entry:	Via keypad or interface
Weight:	Approx. 5 kg
Housing dimensions(HxWxD):	151 x 237 x 285 [mm] with handles T = 325 mm
Device safety:	According to EN 61010
Protection type:	IP 40

Terminals

Rx input (test object):	5-pole Tuchel socket, series C 70 B T 3015000, with a bayonet catch
Pt100-Sensor:	6-pole LEMO socket EGG. 1B. 306
Analog I/O:	9-pole, subminiature D plug Temperature transmitter input 0 ... 10 V, 0 ... 20 mA, 4 ... 20 mA Analog output 0 ... 10 V, scaling error ≤ 2,5%,
Digital I/O: (PLC)	37-pole, subminiature D socket External DC supply 20 V ... <u>24 V</u> ... 30 V 5 relay contacts (NO) and 5 optocouplers for selection 5 bits for binary selection of device settings + transfer 4 bits for the control input 3 bits for the control output START/STOP for measurements, comparator Datalogger, min./max., printer START/STOP for measurements with a footswitch

Interface terminals:

RS232C-Interface:	Full-duplex 9-pole Baud rate Protocol Command language	Subminiatur D socket 300 - 38 400 ANSI X 3.28-1976 Subcategory 2.1, A3 SCPI, Version 1995.0
-------------------	--------------------------------------------------------------------	------------------------------------------------------------------------------------------------------

IEEE488 interface (optional):	24-pole standardized plug connection, open collector output SH1, AH1, T6, TEØ, L4, LEØ, SR1, RL1, PPØ, DC1, DTØ, CØ
Command language:	SCPI, Version 1995.0

Printer:	Connection to an RS232 interface
----------	----------------------------------

Please refer to the data sheet for details of the accessories available. You can obtain the latest data sheet and additional information on the RESISTOMAT® model 2329 from <https://goo.gl/JXihbf>.

9. Disposal



Battery disposal

As an end user, you are required by law (battery ordinance) to return all used batteries and rechargeable batteries; the disposal through household waste is prohibited. By buying the herein described device you are concerned by this law. Please dispose of your batteries and rechargeable batteries correctly. Hand them to waste disposal sites either at your premises or at our company or at any place where batteries/rechargeable batteries are sold.

Equipment Disposal

Please fulfill your legal obligations and dispose of unserviceable equipment in accordance with applicable legal requirements. Thus you contribute to environmental protection.



10. Appendix - Control Example for device settings







Example for device setting:

Test object:	Coil approx. 1.5 Ω	(set Z)
Evaluation:	2 Limits	(set 2LI)
	lower Limit 1.4 Ω	
	upper Limit 1.6 Ω	
Temperatur compensation:	Material of the coil wire with Pt100 is copper (set TC 3980 ppm)	
Meas. mode:	Continuous measurement	
Meas. range:	2 Ω manual range selection	
Memory:	All the mentioned settings should be stored in the measure program 1	

Device ON





















: Identification menu appears for 5 sec., after this time the device goes to the main menu.

Now press following keys:









-  : Parameter selection menu appears, cursor pos. MEAS:PARAMETER
-  : Range select MAN/AUTO., with key  set MAN (see manual pageSeite 37)
-  : Meas. range
-  : Press this key as much as "RANGE 2 OHM" appears.
-  : Test object
-  : Test object : set Z

RESISTOMAT® Model 2329

- ⬇️ 2 : Meas. mode
- ➡️ 6 : Meas. mode : set CONTINUOUS
- F4 : Parameter selection menu
- ⬇️ 2 : Choose temperature compensation (see manual pageSeite 46)
- F1 : Temp. Comp. menu
- ➡️ 6 : TEMP. COMP. : ON
- ⬇️ 2 : Activation of temp.-meas.
- ➡️ 6 : MEASUREMENT : Pt100
- F2 : Choose the temp.-coefficient
- ⬇️ 2 : Choose TC5 3980
- F4 F4 : Press 2x F4, return to parameter selection menu.
- ⬇️ 2 : Comparator setting menu (see manual page 42)
- F1 : Comparator menu
- ➡️ 6 : COMPARATOR : ON
- ⬇️ 2 : Limits
- ➡️ 6 : Count of limiters : 2
- ⬇️ 2 : Relay: With key ⬇️ 6 you can choose, whether only the PLC outputs are active, or PLC outputs and relays.

-  : Switch to page 2 (S2) and set the limits
-  : Set the lower limit LLI
- 



- 
 : Set the upper limit ULI
- 



-  : Parameter selection menu
-  : Choose page 2 (S2) in the parameter selection menu.
-  : Store the device setting
-  : Device setting menu (see manual pageSeite 51)
-  : Input the device setting number
- e.g.
 

-  : Return to the main menu

Load the stored device setting from the main menu (page Seite 51)

-  : Parameter selection menu
-  : Go to page 2 (S2)
-  : Setup the device
-  : Device setting
-  : Choose the load number
 

-  : Set the load number
-  : Now the stored device settings with the store number 1 will load in the main menu.