

OPERATION MANUAL

DIGIFORCE[®] 9311 PROFINET manual

© 2018 burster
praezisionsmesstechnik gmbh & co kg
All rights reserved

Manufacturer:
burster
praezisionsmesstechnik gmbh & co kg
Talstraße 1 - 5 P.O.Box 1432
D-76593 Gernsbach D-76593 Gernsbach
Germany Germany

Valid from: **22.06.2018**
Applies to: **DIGIFORCE[®] 9311-VXX03**

Tel.: (+49) 07224 645-0
Fax.: (+49) 07224 645-88
E-Mail: info@burster.com
www.burster.com

Warranty disclaimer

All information in the present documentation was prepared and compiled with great care and reproduced in accordance with effective control measures. This documentation may contain errors, and the information it contains and the corresponding technical data are subject to change without notice. Reproduction of any part of this documentation or its processing or revision using electronic systems is prohibited without the manufacturer's prior written approval.

Components, devices and measurement sensors made by burster praezisionsmesstechnik (hereinafter referred to as the "product") are the result of targeted development and meticulous research. From the date of delivery, burster provides a warranty for the proper condition and functioning of these products covering material and production defects for the period specified in the warranty document accompanying the product. However, burster waives any guarantee or warranty obligations or any additional liability for consequential damages caused by improper use of the product, in particular the implied guarantee of success in the market as well as the suitability of the product for a particular purpose. Furthermore, burster assumes no liability for direct, indirect or incidental damages or for consequential or other damages arising from the provision and use of the present documentation.



Certificate

PROFIBUS Nutzerorganisation e.V. grants to

burster praezisionsmesstechnik gmbh & co kg
Talstrasse 1 - 5, 76593 Gernsbach, Germany

the Certificate No: **Z11426** for the PROFINET IO Device:

Model Name: DIGIFORCE 9311-VXX03
Revision: SW/FW: V18.1.0; HW: 1
Identnumber: 0x01CE; 0x0002
GSD: GSDML-V2.31-BURSTER-DIGIFORCE-9311-20180522-115200.xml
DAP: DIM 24, 0x00000001

This certificate confirms that the product has successfully passed the certification tests with the following scope:

<input checked="" type="checkbox"/>	PNIO_Version	V2.3
<input checked="" type="checkbox"/>	Conformance Class	A, B
<input checked="" type="checkbox"/>	Netload Class	III
<input checked="" type="checkbox"/>	PNIO_Tester_Version	V2.3.5
<input checked="" type="checkbox"/>	Tester	an testlabs, Prague, Czech Republic PN000-179

This certificate is granted according to the document:

"Framework for testing and certification of PROFIBUS and PROFINET products".

For all products that are placed in circulation by **April 29, 2019** the certificate is valid for life.

Karlsruhe, June 07, 2018



(Official in Charge)



Board of PROFIBUS Nutzerorganisation e. V.

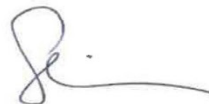

(Karsten Schneider)



(Dr. Jörg Hähnliche)

Contents

1	For your safety	7
1.1	Symbols used in the instruction manual.....	7
1.1.1	Signal words	7
1.1.2	Pictograms	7
1.2	Symbols and precautionary statements on the instrument.....	8
1.2.1	Conventions used in the instruction manual.....	8
1.3	Abbreviations.....	8
2	Introduction	9
2.1	General safety instructions.....	9
2.2	Intended use.....	10
3	Technical data	11
3.1	Supported PROFINET-functions.....	11
3.2	Model 9311 device data	11
3.3	Electrical safety	11
3.4	Electromagnetic compatibility.....	12
3.4.1	Interference immunity	12
3.4.2	Emitted interference.....	12
3.5	Notes on CE labeling.....	12
4	Installation	13
4.1	Connection of fieldbus lines	13
4.2	Meaning of LED states	13
4.3	Port-Identification	13
4.4	Configuration of a PROFINET network.....	14
4.5	Configuration menu in DIGIFORCE® 9311	15
5	PROFINET	17
5.1	General information on PROFINET data transfer	17
5.2	GSDML file.....	17
5.3	Data conversion	18
5.3.1	Description of the data formats in this manual	18
5.3.2	Handling problems that arise when reading floating-point numbers	18
6	Alarms	19
7	PROFINET data protocol	20
7.1	Meaning of the content of the cyclic data packet from device to the controller	20
7.2	PLC inputs – Transfer from controller to device.....	20
7.2.1	PLC inputs byte 0 (controller to device).....	21
7.2.2	PLC inputs byte 1 (controller to device).....	21
7.2.3	PLC inputs byte 2 (controller to device).....	22

7.3	PLC outputs – Transfer from device to controller	23
7.3.1	PLC outputs byte 0	23
7.3.2	PLC outputs byte 1	24
7.4	Evaluation info – Transfer from device to controller.....	25
7.4.1	Evaluation info byte 0	25
7.4.2	Evaluation info byte 1	25
7.5	Byte reference list.....	26
8	Acyclic PROFINET services	30
8.1	Instrument configuration.....	30
8.1.1	General settings (Slot 30)	30
8.1.2	Communication: Change menu, display update, fault indication (Slot 32).....	36
8.1.3	Program Selection/Renaming & Statistics reset (Slot 32)	37
8.1.4	General channel settings (Slot 33)	37
8.1.5	Channel settings “Standard signal” (Slot 34).....	40
8.1.6	Channel settings “Strain gauge” (Slot 35)	40
8.1.7	Channel settings “Piezo” (Slot 36).....	41
8.1.8	Tare (Slot 37)	41
8.1.9	Measurement mode (Slot 38)	42
8.1.10	Evaluation window 1 (Slot 39)	43
8.1.11	Evaluation window 2 (Slot 40)	45
8.1.12	Evaluation window 3 (Slot 41)	45
8.1.13	Evaluation trapezoid window 1 (Slot 42)	46
8.1.14	Evaluation trapezoid window 2 (Slot 43)	48
8.1.15	Evaluation threshold 1 (Slot 44).....	48
8.1.16	Evaluation threshold 2 (Slot 45).....	49
8.1.17	Evaluation envelope (Slot 46 to 50).....	49
8.1.18	Tolerance band for evaluation elements (Slot 51).....	50
8.1.19	Realtime switchpoints S1 (Slot 52).....	50
8.1.20	Realtime switchpoints S2 (Slot 53).....	51
8.1.21	Realtime switchpoints S3 (Slot 54).....	51
8.1.22	Realtime switchpoints S4 (Slot 55).....	51
8.1.23	Realtime switchpoints S5 (Slot 56).....	51
8.1.24	Realtime switchpoints S6 (Slot 57).....	52
8.1.25	Sensortest (Slot 58)	52
8.1.26	Setup user-defined values (Slot 59)	53
8.1.27	Copy/initialize measurement programs (Slot 60).....	54
8.1.28	Reference curve (Slot 61 to 63).....	55
8.1.29	Test operation (Slot 64)	55
8.1.30	Zoom and autoscale (Slot 65).....	55
8.1.31	USB-Logging (Slot 66).....	56
8.1.32	TEDS-Sensors (Slot 67)	56

8.1.33	Reserved slots (Slots 68...78)	56
8.2	Measurement results	57
8.2.1	Status of measurement (Slot 79)	57
8.2.2	Further information for current measurement curve (Slot 80)	57
8.2.3	General curve data (Slot 81).....	58
8.2.4	Request measurement results of user-defined values (Slot 82)	59
8.2.5	Read-out X-coordinates of current measurement curve (Slot 83).....	64
8.2.6	Read-out Y-coordinates of current measurement curve (Slot 84).....	66
8.2.7	Evaluation results window 1 (Slot 85).....	66
8.2.8	Evaluation results window 2 (Slot 86).....	66
8.2.9	Evaluation results window 3 (Slot 87).....	67
8.2.10	Evaluation results threshold 1 (Slot 88).....	67
8.2.11	Evaluation results threshold 2 (Slot 89).....	67
8.2.12	Evaluation results trapezoid window 1 (Slot 90).....	68
8.2.13	Evaluation results trapezoid window 2 (Slot 91).....	68
8.2.14	Evaluation results envelope (Slot 92)	68
8.2.15	Combined results (common curve data and evaluation elements – Slot 93)	69
9	Appendix	72
9.1	Operand table.....	72
9.2	Error Codes	76



1 For your safety

The following symbols on the DIGIFORCE® 9311 and in this operation manual warn of hazards.

1.1 Symbols used in the instruction manual

1.1.1 Signal words



The following signal words are used in the operation manual according to the specified hazard classification.

	DANGER
High degree of risk: indicates a hazardous situation which, if not avoided, will result in death or serious injury.	
	WARNING
Moderate degree of risk: indicates a hazardous situation which, if not avoided, may result in death or serious injury.	
	CAUTION
Low degree of risk: indicates a hazardous situation which, if not avoided, could result in minor or moderate injury.	
NOTICE	
Property damage to the equipment or the surroundings will result if the hazard is not avoided.	

Note: It is important to heed these safety notices in order to ensure you handle the DIGIFORCE® 9311 correctly.

Caution: Follow the information given in the operation manual.

1.1.2 Pictograms

Symbol	Description
	Warning concerning the use and installation of the device and software.
	Observe the advice for protecting the instrument.

1.2 Symbols and precautionary statements on the instrument

Symbol	Description
	Hazard warning Disconnect the power plug before opening – Follow safety instructions – Professional servicing only
Warning ! To prevent electrical shock do not open device.	Warning of electrical shock hazard Do not open the unit.
To prevent fire replace only with same type and rating of fuse !	Warning of fire hazard Always replace the fuse with a fuse of the same type and rating.

1.2.1 Conventions used in the instruction manual



Designation	Description
[Fx]	Function keys F1 to F3 on the touchscreen display
[Text]	Buttons on the touchscreen display
"Term"	Terms used in the instrument menus



1.3 Abbreviations

Abbreviation	Description
BF	Bus error
GSD	Device description data
GSDML	The GSDML file describes the physical properties of the device.
PI	PROFIBUS and PROFINET International (user organization)

2 Introduction

2.1 General safety instructions

	 <h2 style="margin: 0;">DANGER</h2>
	<p>Warning concerning installation of the device and software</p> <p>Installation of the device and the interface must be carried out by qualified personnel only. Qualified personnel meets the following requirements:</p> <ul style="list-style-type: none"> • You are familiar with the safety designs used in automation engineering, and understand how to deal with them in your capacity as configuration engineer. • You are an operator of automation systems and have been instructed in how to handle the system. You are familiar with the operation of the equipment described in this documentation. • You are a commissioning or service engineer and have successfully completed a training course qualifying you to repair automation systems. In addition you are authorized to commission, ground and label circuits and equipment in accordance with safety engineering standards. <p>Always observe the current safety and accident prevention regulations when commissioning the equipment. Install automation engineering equipment and installations with sufficient protection against accidental actuation.</p>

	 <h2 style="margin: 0;">DANGER</h2>
	<p>Warning concerning use of the device</p> <ul style="list-style-type: none"> • Take suitable precautions in both the hardware and software to prevent any undefined states of the automation installation in the event of an open circuit. • In installations where major damage to property or even personal injury may be caused by a malfunction, take suitable precautions to establish a safe operating state in the event of a fault. This may be achieved using limit switches, mechanical interlocks etc. for example. • Do not make unauthorized modifications to the device or to the PROFINET interface.

	<h2 style="margin: 0;">NOTICE</h2>
	<ul style="list-style-type: none"> • Install the power, signal and sensor cables so as to prevent electromagnetic interference from impairing operation of the equipment. • Proper transportation, storage, installation and assembly plus careful operation and maintenance are essential for trouble-free and safe operation of the equipment. • Have non-functional instruments inspected by the manufacturer.

2.2 Intended use

The DIGIFORCE[®] 9311 is an instrument for monitoring repetitive production processes. Its core function is to record and analyze signals from processes in which physical variables, such as force, pressure or torque, vary as a function of displacement, angle or time according to a defined curve. The resultant measurement curve is analyzed using graphical evaluation elements such as windows, envelopes and thresholds. The result of the analysis is classified as "OK" or "NOT OK" (NOK) and can be retrieved from various interfaces.

The instrument is not a substitute for a safety device; for instance it cannot be used as an emergency stop device in a press for when the pressure exceeds a set limit.

3 Technical data

3.1 Supported PROFINET-functions

- Conformance Classes: A, B
- Shared Device
- Media Redundancy Protocol (MRP)
- Link Layer Discovery Protocol (LLDP)
- I&M Services (I&M0-I&M4)

*Specified according to PROFINET version 2.3

I&M0 identification

Parameter	Value
Vendor-ID	0x01CE
Order-ID	9311-VXX03
Serial	931115
HW-Version	1
SW-Version	V16.1.0
Rev.-Counter	0
Profile-ID	0xF600
Profile type	0x0000
I&M-Version	0x0101
I&M-Support	I&M1...I&M4

Diagram 1: I&M0 identification

Profil-ID: 0xF600 (Generic Device)

You will find further information about PROFINET at: www.profibus.com.

3.2 Model 9311 device data

Bus connector	RJ45
GSD file	GSDML-V2.31-BURSTER-DIGIFORCE-9311-20160329-155500.xml

3.3 Electrical safety

Reverse voltage protection	Yes
Air clearance/leakage paths	To EN 61010-1:2010
Electrical isolation	Between fieldbus and internal electronics
Withstand voltage	DC 500 V

3.4 Electromagnetic compatibility

3.4.1 Interference immunity

Interference immunity to EN 61326-1:2013

Industrial locations

3.4.2 Emitted interference

Emitted interference to EN 61326-1:2013

Class A

EN 61000-3-2:2014

EN 61000-3-3:2013

3.5 Notes on CE labeling

burster equipment carrying the CE mark meets the requirements of the EU directives and the harmonized European standards (EN) cited therein.

The EU declarations of conformity are available to the relevant authorities as specified in the directives. A copy of the declaration of conformity is included in the relevant equipment documentation.

4 Installation

Please note that you can download various documents such as installation guidelines and specifications about PROFINET at PI: www.profibus.com.

4.1 Connection of fieldbus lines

burster devices with a PROFINET option have two **RJ 45** connectors for the fieldbus connection.

4.2 Meaning of LED states



LED	Blinking	On
ACT	Data transmission	x
LNK / LA	PROFINET device localization	Ethernet line monitoring
SF	x	System error
US2	x	Sensor supply voltage
BF	Bus error	
BOOT	DCP signal confirmation	x
US1	x	Supply voltage

4.3 Port-Identification

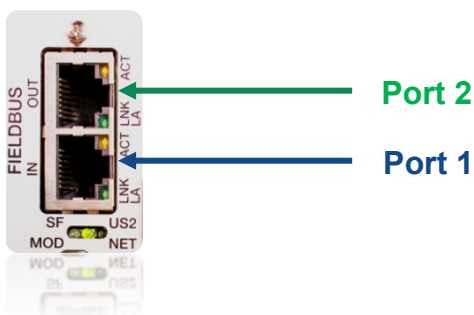

4.4 Configuration of a PROFINET network

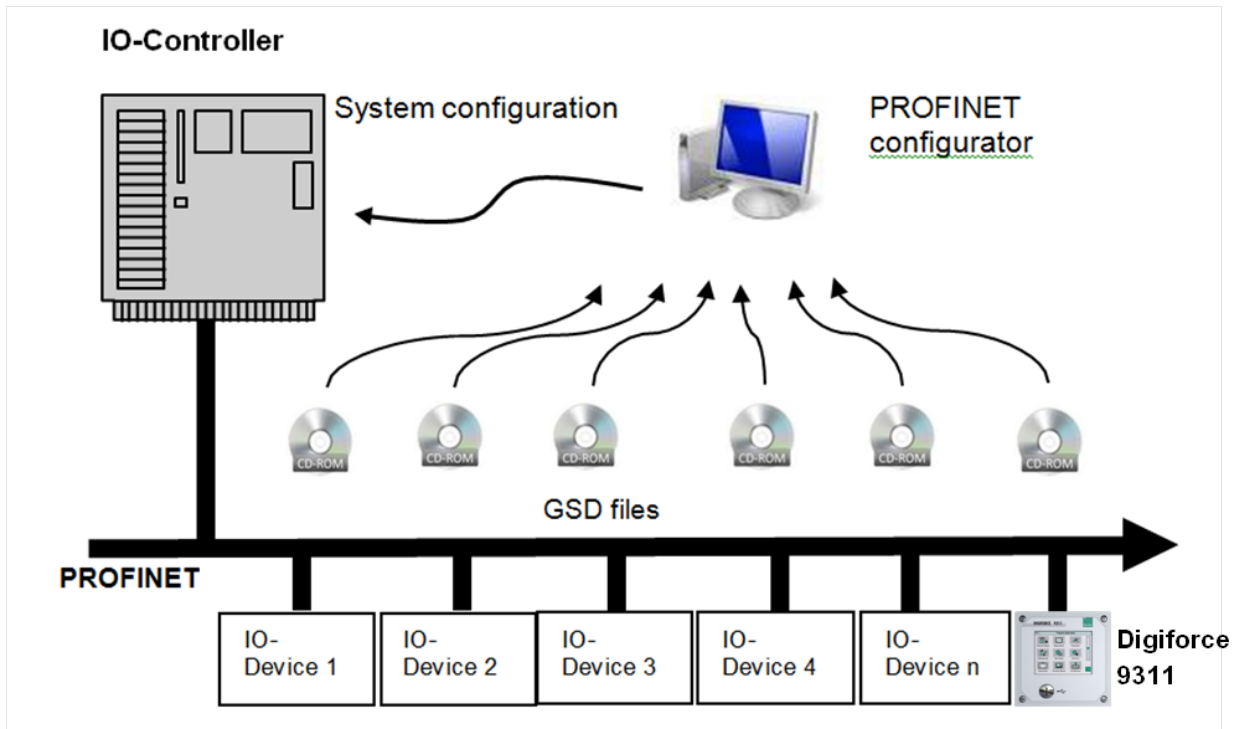

Diagram 2: Configuration of a PROFINET network

4.5 Configuration menu in DIGIFORCE[®] 9311



To access the menu

Start in measurement mode. After power on the measurement mode is always set. The display will look differently dependent on your settings or your last measurements.

PROFINET settings for the DIGIFORCE[®] 9311 are configured via the "PROFINET" menu.



This is how it works

- 1 In measurement mode, tap anywhere on the touchscreen. The  icon appears in the bottom-right corner.
- 2 Tap  to open the "Configuration Main Menu".
- 3 Tap the "Basic setup" icon.
- 4 Tap the "PROFINET" icon.

P 0	PROFINET	M76
SW-version	PN-V201600	
Serial number	01234567	
Control via	PROFINET	
Device MAC	00-23-6E-00-00-01	
Port1 MAC	00-23-6E-00-00-02	
Port2 MAC	00-23-6E-00-00-03	
Name of station	digiforce9311	

Diagram 3: PROFINET settings

Parameters in the "PROFINET" menu (M76)

SW-version	Firmware version of the PROFINET Fieldbus module
Serial number	Serial number of the Fieldbus module
Control via	<p>PROFINET: the DIGIFORCE[®] 9311 responds solely to control signals (inputs) from the PROFINET interface.</p> <p>PLC: the DIGIFORCE[®] 9311 responds solely to control signals (inputs) from the PLC I/O interface.</p> <p>When control via PLC I/O is selected, data is still transferred on the PROFINET real-time channel.</p>
Device MAC	Address for identifying the Fieldbus module in the PROFINET network.
Port1 MAC	Port 1 MAC address
Port2 MAC	Port 2 MAC address

Name of station	The station name assigned by the PROFINET host.
IP address	Assigned IP address Please note: this parameter cannot be changed in the DIGIFORCE [®] 9311.

5 PROFINET

5.1 General information on PROFINET data transfer

For PROFINET (cyclic data traffic), one must define at the configuration stage how many bytes are transferred between Controller and Device during each cyclic access (GSDML file).

The device is controlled using the data transferred from Controller to Device. This data always consists of three bytes for the DIGIFORCE® 9311 unit. The function of these three bytes is explained in chapter 6.2 PLC inputs – Transfer from controller to device.

The DIGIFORCE® 9311 sends cyclic 92 bytes to controller. This packet contains PLC status and evaluation information and 20 measurement values which are user selectable within the 9311 configuration and the live values of max. 2 active measurement channels.

5.2 GSDML file

DIGIFORCE® equipment with the PROFINET option is supplied with a CD. This disk includes the device description file *GSDML-V2.31-BURSTER-DIGIFORCE-9311-20160329-155500* (GSDML file). This GSDML file describes the physical properties of the device.

The structure, contents and encoding of this device description data is standardized so that any Profinet devices can be configured using configuration tools from various manufacturers.

The GSDML file does not specify what data is transferred or how this data should be interpreted. The user must glean this information from the operating manual and program his Controller accordingly.

5.3 Data conversion

5.3.1 Description of the data formats in this manual

The terms PLC inputs and PLC outputs refer to the DIGIFORCE® 9311 unit. These terms are reversed when referred to the Controller.

The function of the PLC-In / PLC-Out bits is identical to the parallel PLC I/O ports on the unit itself and can be found in the DIGIFORCE® 9311 operating manual.

The floating-point numbers ("float") mentioned are four bytes long (32 bits) and are based on the IEEE-754 standard.

Numbers that are not specifically labeled or are labeled with "d" or "dec" are decimal numbers. (Example: 1234, 1234dec, dec1234, 1234d)

Numbers that are labeled with "0x" or "hex" are hexadecimal numbers. (Example: 0x1234, hex1234, 1234hex, 1234h)

Numbers that are labeled with "b" or "bin" are binary numbers. (Example: b1100, bin1100, 1100b, 1100bin).

5.3.2 Handling problems that arise when reading floating-point numbers

This only concerns cases in which floating-point numbers need to be read from the DIGIFORCE® 9311 unit.

Floating-point numbers (data type REAL), according to IEEE 754, are encoded as four bytes for transfer. This may create problems depending on the type of PLC used.

Cause

In the DIGIFORCE® 9311-PROFINET, the sign byte is transferred first if using acyclic data transfer and last while cyclic data transmission. Some PLCs expect this byte in the highest of the four addresses not in the lowest address. This inevitably leads to misinterpretation of the numeric value. In this case the order of the four bytes has to be changed by the PLC as shown in the figure.

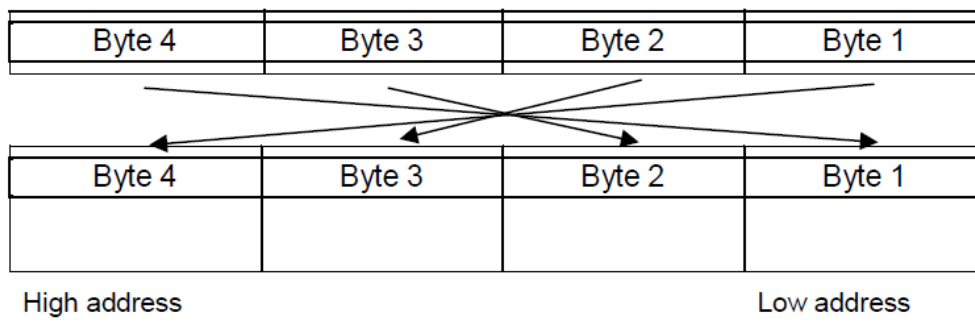

Diagram 4: Exchange of the order of bytes caused by misinterpretation of the numeric value

6 Alarms

The DIGIFORCE[®] 9311 supports process alarms. Currently one alarm only is available. For the handling of alarms slot 200 is reserved.

Process Alarm:	<i>Device Error</i> is sent if a measurement channel is overloaded or the device is not ready for the measurement.
Slot:	200
Subslot:	1
User structure identifier:	1
Alarm text:	Device error (e.g. measurement channel overload or device is not ready)
Alarm text length (Byte):	71

7 PROFINET data protocol

7.1 Meaning of the content of the cyclic data packet from device to the controller

Overview of the packet content:

Content	Length/Bytes	Bytes
PLC output status	2	Σ 92 bytes
Evaluation info	2	
20 evaluation values (float) , user-defined values*	20x4	
2 live values (X, Y) * ¹	2x4	

* The user-defined values contain values which are defined within the DIGIFORCE[®] 9311 device. The following values are available:

- General curve data
- Evaluation results of each evaluation element (e.g. window entry/exit window extended evaluation results like Min/Max window limits Xmin, Xmax, Ymin, Ymax threshold crossing point)

*¹ The live values of the sensor channels are updated at a rate of 100 Hz. The values are only updated when the DIGIFORCE[®] 9311 is ready to record measurements or is actively taking a measurement.

How to define the user-defined values: The parameterization of the list is done in the configuration main menu->Program Setup->User-def. Val. (Note that this setting is specific for each measurement program. For details refer to the DIGIFORCE[®] 9311 operation manual, section 6.3.8 User defined values.)

7.2 PLC inputs – Transfer from controller to device

Three bytes of PLC-In data for the DIGIFORCE[®] 9311 are always transferred from the PROFINET Controller to the DIGIFORCE[®] 9311. These bits have the same function as the parallel PLC inputs to the DIGIFORCE[®] 9311 unit. (See detailed documentation of these signals within the DIGIFORCE[®] 9311 operation manual, section 6.1.3 PLC inputs).

7.2.1 PLC inputs byte 0 (controller to device)

PLC inputs Byte 0 (Controller → Device)		
Valid values:	Adjustable input #1 (Pin 4) Default: IN_TARE_X	Bit 0 LSB
	Adjustable input #2 (Pin 5) Default: IN_RES_STAT	Bit 1
Set reserved bits to '0'	Adjustable input #3 (Pin 6) Default: IN_STEST	Bit 2
	IN_STROBE	Bit 3
	IN_AUTO	Bit 4
	Reserved	Bit 5
	Reserved	Bit 6
	Reserved	Bit 7 MSB



NOTICE

Note that the adjustable PLC inputs (Pin 4, 5 and 6) can be assigned with different functions. The assignment can be changed within the DIGIFORCE® 9311 “Basic setup” menu (M18) under “Assignment of the PLC inputs” (for further information see DIGIFORCE® model 9311 operation manual chapter 6.1.3 “PLC inputs”).

7.2.2 PLC inputs byte 1 (controller to device)

PLC inputs Byte 1 (Controller → Device)		
Valid values:	IN_PROG0	Bit 0 LSB
	IN_PROG1	Bit 1
Set reserved bits to '0'	IN_PROG2	Bit 2
	IN_PROG3	Bit 3
	Reserved	Bit 4
	Reserved	Bit 5
	Reserved	Bit 6
	Reserved	Bit 7 MSB

7.2.3 PLC inputs byte 2 (controller to device)

PLC inputs Byte 2 (Controller → Device)		
Valid values:	IN_START	Bit 0 LSB
	Reserved	Bit 1
Set reserved bits to '0'	Reserved	Bit 2
	Reserved	Bit 3
	Reserved	Bit 4
	Reserved	Bit 5
	Reserved	Bit 6
	Reserved	Bit 7 MSB

7.3 PLC outputs – Transfer from device to controller

The data refers to the PLC output of the DIGIFORCE[®] 9311. The data described here is the data transferred from the DIGIFORCE[®] 9311 to the PROFINET controller.

The function of the PLC-In / PLC-Out bits is identical to the parallel PLC I/O ports on the unit itself and can be found in the DIGIFORCE[®] 9311 operation manual for the unit. Also the signal timing is available within the DIGIFORCE[®] 9311 operation manual.

7.3.1 PLC outputs byte 0

PLC outputs Byte 0 (Device → Controller)		
Valid values:	OUT_READY	Bit 0 LSB
	OUT_OK	Bit 1
	OUT_NOK	Bit 2
	OUT_NOK_ONL	Bit 3
	OUT_S1	Bit 4
	OUT_S2	Bit 5
	Adjustable output #1 (Pin 20) Default: OUT_OK_STEST	Bit 6
	Adjustable output #6 (Pin 25) Default: OUT_MEAS_ACT	Bit 7 MSB

7.3.2 PLC outputs byte 1

PLC outputs Byte 1 (Device → Controller)		
Valid values:	Adjustable output #2 (Pin 21) Default: OUT_STROBE	Bit 0 LSB
	Adjustable output #3 (Pin 22) Default: OUT_PROG0	Bit 1
	Adjustable output #4 (Pin 23) Default: OUT_PROG1	Bit 2
	Adjustable output #5 (Pin 24) Default: OUT_PROG2	Bit 3
	Reserved	Bit 4
	Reserved	Bit 5
	Reserved	Bit 6
	Reserved	Bit 7 MSB



NOTICE

Note that PLC outputs [6..1] can be assigned with different functions. The assignment can be changed within the DIGIFORCE[®] 9311 “Basic setup” menu (M18) under “Assignment of the PLC outputs”(see DIGIFORCE[®] model 9311 operation manual chapter 6.1.2 “PLC outputs”).

7.4 Evaluation info – Transfer from device to controller

The evaluation info (2 bytes) contains the evaluation result of each element.

7.4.1 Evaluation info byte 0

Evaluation info byte 0 (Device → Controller)		
Valid values:	Global_NOK	Bit 0 LSB
	Overload_NOK	Bit 1
	Window_1_NOK	Bit 2
	Window_2_NOK	Bit 3
	Window_3_NOK	Bit 4
	Threshold_1_NOK	Bit 5
	Threshold_2_NOK	Bit 6
	Trapezoid_1_NOK	Bit 7 MSB

7.4.2 Evaluation info byte 1

Evaluation info byte 1 (Device → Controller)		
Valid values:	Trapezoid_2_NOK	Bit 0 LSB
	Envelope_NOK	Bit 1
	Measurement w/o READY	Bit 2
	USB logging error	Bit 3
	Reserved	Bit 4
	Reserved	Bit 5
	Reserved	Bit 6
	Reserved	Bit 7 MSB

7.5 Byte reference list

Data from controller to device

Byte	Function	Section	Comments
0	PLC inputs Byte 0	7.2.1	
1	PLC inputs Byte 1	7.2.2	
2	PLC inputs Byte 2	7.2.3	

Data from device to controller

Byte	Function	Section	Comments
0	PLC outputs Byte 0	7.3.1	
1	PLC outputs Byte 1	7.3.2	
2	Evaluation info Byte 0	7.4.1	
3	Evaluation info Byte 1	7.4.2	
4	User-defined value_1 (1 st Byte)	see DIGIFORCE® 9311 operation manual 6.3.8 User defined values	User defined value in DIGIFORCE® 9311 (32-Bit float)
5	User-defined value_1 (2 nd Byte)	see above	
6	User-defined value_1 (3 rd Byte)	see above	
7	User-defined value_1 (4 th Byte)	see above	
8	User-defined value_2 (1 st Byte)	see above	User defined value in DIGIFORCE® 9311 (32-Bit float)
9	User-defined value_2 (2 nd Byte)	see above	
10	User-defined value_2 (3 rd Byte)	see above	
11	User-defined value_2 (4 th Byte)	see above	
12	User-defined value_3 (1 st Byte)	see above	User defined value in DIGIFORCE® 9311 (32-Bit float)
13	User-defined value_3 (2 nd Byte)	see above	
14	User-defined value_3 (3 rd Byte)	see above	
15	User-defined value_3 (4 th Byte)	see above	
16	User-defined value_4 (1 st Byte)	see above	User defined value in DIGIFORCE® 9311 (32-Bit float)
17	User-defined value_4 (2 nd Byte)	see above	
18	User-defined value_4 (3 rd Byte)	see above	
19	User-defined value_4 (4 th Byte)	see above	
20	User-defined value_5 (1 st Byte)	see above	User defined value in

Byte	Function	Section	Comments
21	User-defined value_5 (2 nd Byte)	see above	DIGIFORCE [®] 9311 (32-Bit float)
22	User-defined value_5 (3 rd Byte)	see above	
23	User-defined value_5 (4 th Byte)	see above	
24	User-defined value_6 (1 st Byte)	see above	User defined value in DIGIFORCE [®] 9311 (32-Bit float)
25	User-defined value_6 (2 nd Byte)	see above	
26	User-defined value_6 (3 rd Byte)	see above	
27	User-defined value_6 (4 th Byte)	see above	
28	User-defined value_7 (1 st Byte)	see above	User defined value in DIGIFORCE [®] 9311 (32-Bit float)
29	User-defined value_7 (2 nd Byte)	see above	
30	User-defined value_7 (3 rd Byte)	see above	
31	User-defined value_7 (4 th Byte)	see above	
32	User-defined value_8 (1 st Byte)	see above	User defined value in DIGIFORCE [®] 9311 (32-Bit float)
33	User-defined value_8 (2 nd Byte)	see above	
34	User-defined value_8 (3 rd Byte)	see above	
35	User-defined value_8 (4 th Byte)	see above	
36	User-defined value_9 (1 st Byte)	see above	User defined value in DIGIFORCE [®] 9311 (32-Bit float)
37	User-defined value_9 (2 nd Byte)	see above	
38	User-defined value_9 (3 rd Byte)	see above	
39	User-defined value_9 (4 th Byte)	see above	
40	User-defined value_10 (1 st Byte)	see above	User defined value in DIGIFORCE [®] 9311 (32-Bit float)
41	User-defined value_10 (2 nd Byte)	see above	
42	User-defined value_10 (3 rd Byte)	see above	
43	User-defined value_10 (4 th Byte)	see above	
44	User-defined value_11 (1 st Byte)	see above	User defined value in DIGIFORCE [®] 9311 (32-Bit float)
45	User-defined value_11 (2 nd Byte)	see above	
46	User-defined value_11 (3 rd Byte)	see above	
47	User-defined value_11 (4 th Byte)	see above	
48	User-defined value_12 (1 st Byte)	see above	User defined value in DIGIFORCE [®] 9311 (32-Bit float)
49	User-defined value_12 (2 nd Byte)	see above	

Byte	Function	Section	Comments
50	User-defined value_12 (3rd Byte)	see above	
51	User-defined value_12 (4th Byte)	see above	
52	User-defined value_13 (1st Byte)	see above	User defined value in DIGIFORCE® 9311 (32-Bit float)
53	User-defined value_13 (2nd Byte)	see above	
54	User-defined value_13 (3rd Byte)	see above	
55	User-defined value_13 (4th Byte)	see above	
56	User-defined value_14 (1st Byte)	see above	User defined value in DIGIFORCE® 9311 (32-Bit float)
57	User-defined value_14 (2nd Byte)	see above	
58	User-defined value_14 (3rd Byte)	see above	
59	User-defined value_14 (4th Byte)	see above	
60	User-defined value_15 (1st Byte)	see above	User defined value in DIGIFORCE® 9311 (32-Bit float)
61	User-defined value_15 (2nd Byte)	see above	
62	User-defined value_15 (3rd Byte)	see above	
63	User-defined value_15 (4th Byte)	see above	
64	User-defined value_16 (1st Byte)	see above	User defined value in DIGIFORCE® 9311 (32-Bit float)
65	User-defined value_16 (2nd Byte)	see above	
66	User-defined value_16 (3rd Byte)	see above	
67	User-defined value_16 (4th Byte)	see above	
68	User-defined value_17 (1st Byte)	see above	User defined value in DIGIFORCE® 9311 (32-Bit float)
69	User-defined value_17 (2nd Byte)	see above	
70	User-defined value_17 (3rd Byte)	see above	
71	User-defined value_17 (4th Byte)	see above	
72	User-defined value_18 (1st Byte)	see above	User defined value in DIGIFORCE® 9311 (32-Bit float)
73	User-defined value_18 (2nd Byte)	see above	
74	User-defined value_18 (3rd Byte)	see above	
75	User-defined value_18 (4th Byte)	see above	
76	User-defined value_19 (1st Byte)	see above	User defined value in DIGIFORCE® 9311 (32-Bit float)
77	User-defined value_19 (2nd Byte)	see above	
78	User-defined value_19 (3rd Byte)	see above	

Byte	Function	Section	Comments
79	User-defined value_19 (4 th Byte)	see above	
80	User-defined value_20 (1 st Byte)	see above	User defined value in DIGIFORCE [®] 9311 (32-Bit float)
81	User-defined value_20 (2 nd Byte)	see above	
82	User-defined value_20 (3 rd Byte)	see above	
83	User-defined value_20 (4 th Byte)	see above	
84	Live value Channel X (1 st Byte)		
85	Live value Channel X (2 nd Byte)		
86	Live value Channel X (3 rd Byte)		
87	Live value Channel X (4 th Byte)		
88	Live value Channel Y (1 st Byte)		(32-Bit float) Channel Y live value Updating rate of the live values ¹⁰⁰ / _{sec.}
89	Live value Channel Y (2 nd Byte)		
90	Live value Channel Y (3 rd Byte)		
91	Live value Channel Y (4 th Byte)		

8 Acyclic PROFINET services

The services are described from the point of view of the controller.

Please Note: The subplot number has always to be set to 1.

The acyclic PROFINET services allow access to following DIGIFORCE® 9311 functions:

- Complete device configuration
- Transfer of component/worker/job data for logging
- Retrieval of large amounts of process and curve data

For further information and support for Siemens PLC integration please contact our service department at service@burster.com.

8.1 Instrument configuration

8.1.1 General settings (Slot 30)

Slot 30, Indices 0 to 18

Slot	Index	Description	Value	Meaning of value	Type	Len	R/W
30	0		-	Not possible			X
30	1...9	Reserved	-	Not possible			X
30	10	Device detection	<i>DIGIFORCE model 9311</i>		STR18	18	RO
30	11	Serial number	<i>12345678</i>		STR11	11	RO
30	12	Software version	<i>V201600</i>		STR25	25	RO
30	13	Version boot loader software	<i>V201500</i>		STR25	25	RO
30	14	Software version Field bus interface	<i>PN-V201600</i>		STR25	25	RO
30	15	Optional analog interface enabled	<i>0 1 2 3</i>	Strain gauge+Potent. Piezo+Potentiometer Strain gauge+Incrim. Piezo+Incremental	U16	2	RO
30	16	Info: Calibration date analog interface	<i>07.11.2016</i>		STR10	10	RO
30	17	Station name	<i>Stat14 right</i>		STR15	15	RW
30	18	reserved	-	-	-	-	-

Slot 30, Indices 19 to 35

Slot	Index	Description	Value	Meaning of value	Type	Len	R/W
30	19	Language	0	German	U16	2	RW
			1	English			
			2	French			
			3	Spanish			
			4	Italian			
5	Chinese						
30	20	Date	[dd.mm.yyyy]	e.g.: 21.09.2016	STR10	10	RW
30	21	Time	[hh:mm:ss], 24h	e.g.: 16:15:00	STR8	8	RW
30	22	LCD brightness	1 ... 10	Integer value (10 max.)	U16	2	RW
30	23	Measurement menu function key definition F1	0	Off	U16	2	RW
			1	Meas. program incremental			
			2	Meas. program decremental			
			3	Tare X			
			4	Tare Y			
			5	Measurement Start/Stop			
			6	Acknowledge OK parts			
			7	Acknowledge NOK parts			
			8	Sensor test			
			9	Edit mode			
30	24	Measurement menu function key definition F2	0	Off	U16	2	RW
			1	Meas. program incremental			
			2	Meas. program decremental			
			3	Tare X			
			4	Tare Y			
			5	Measurement Start/Stop			
			6	Acknowledge OK parts			
			7	Acknowledge NOK parts			
			8	Sensor test			
			9	Edit mode			
30	25	Measurement menu function key definition F3	0	Off	U16	2	RW
			1	Meas. program incremental			
			2	Meas. program decremental			
			3	Tare X			
			4	Tare Y			
			5	Measurement Start/Stop			
			6	Acknowledge OK parts			
			7	Acknowledge NOK parts			
			8	Sensor test			
			9	Edit mode			
30	26	Display mode of function Keys	0 1	Fade out Always on	U16	2	RW
30	27	Meas. menu display control GRAPHIC	0 1	Meas. menu disabled Meas. menu enabled	U16	2	RW
30	28	Meas. menu display control GENERAL CURVE DATA	0 1	Meas. menu disabled Meas. menu enabled	U16	2	RW

Slot	Index	Description	Value	Meaning of value	Type	Len	R/W
30	29	Meas. menu display control TOTAL (Off/Smiley/text)	0	Meas. menu disabled	U16	2	RW
			1	Smiley			
			2	Text			
30	30	Meas. menu display control ENTRY/EXIT VALUES	0	Meas. menu disabled	U16	2	RW
			1	Meas. menu enabled			
30	31	Meas. menu display control USER DEFINED MEAS. VALUES	0	Meas. menu disabled	U16	2	RW
			1	Meas. menu enabled			
30	32	Meas. menu display control STATISTICS	0	Meas. menu disabled	U16	2	RW
			1	Meas. menu enabled			
30	33	Meas. menu display control ORDER SHEET	0	Meas. menu disabled	U16	2	RW
			1	Meas. menu enabled			
30	34	Show/Hide of Live Values	0	Show Live Values	U16	2	RW
			1	Hide Live Values			
30	35	Display the measurement menu, read the currently displayed measurement menu Note: The menu is selected here, but not yet displayed. Display only occurs through access to slot 30/68.	101	M1 Displaying meas. curves	U16	2	RW
			102	M2 General curve data			
			103	M3 Total Result			
			104	M4 Entry/Exit			
			105	M5 User defined values			
			106	M6 Statistics			
			107	M7 Order sheet			

Slot 30, Indices 36 to 51

Slot	Index	Description	Value	Meaning of value	Type	Len	R/W
30	36	Access authorisation Password protection on/off	0	Password protection on	U16	2	RW
			1	Password protection off			
30	37	Access authorisation BASIC SETUP MENU	0	Access level disabled	U16	2	RW
			1	Access level enabled			
30	38	Access authorisation PROGRAM SELECTION	0	Access level disabled	U16	2	RW
			1	Access level enabled			
30	39	Access authorisation COPY	0	Access level disabled	U16	2	RW
			1	Access level enabled			

Slot	Index	Description	Value	Meaning of value	Type	Len	R/W
		PROGRAMS					
30	40	Access authorisation CURVE ANALYSIS	0 1	Access level disabled Access level enabled	U16	2	RW
30	41	Access authorisation CHANNEL SETTINGS	0 1	Access level disabled Access level enabled	U16	2	RW
30	42	Access authorisation MEASUREMENT MODE	0 1	Access level disabled Access level enabled	U16	2	RW
30	43	Access authorisation EVALUATION	0 1	Access level disabled Access level enabled	U16	2	RW
30	44	Access authorisation REALTIME SWITSCHPOINTS	0 1	Access level disabled Access level enabled	U16	2	RW
30	45	Access authorization TEST OPERATION	0 1	Access level disabled Access level enabled	U16	2	RW
30	46	Access authorisation SENSOR TEST	0 1	Access level disabled Access level enabled	U16	2	RW
30	47	Access authorisation USER DEFINED VALUES	0 1	Access level disabled Access level enabled	U16	2	RW
30	48	Access authorisation EXTERNAL MEMORY	0 1	Access level disabled Access level enabled	U16	2	RW
30	49	Master password	0000 ... 9999		U16	2	RW
30	50	Set Master password to default	EVENT!	Writing an arbitrary byte initiates action	U8	1	WO
30	51	User password	0000 ... 9999		U16	2	RW

Slot 30, Index 52 (Assignment adjustable PLC output 1)

Slot	Index	Description	Value	Meaning of value	Type	Len	R/W
30	52	adj. PLC output 1 (P20)	0	OUT_OK_STEST	U16	2	RW
30	52	adj. PLC output 1 (P20)	1	OUT_STROBE	U16	2	RW
30	52	adj. PLC output 1 (P20)	2	OUT_PROG0	U16	2	RW
30	52	adj. PLC output 1 (P20)	3	OUT_PROG1	U16	2	RW
30	52	adj. PLC output 1 (P20)	4	OUT_PROG2	U16	2	RW
30	52	adj. PLC output 1 (P20)	5	OUT_PROG3	U16	2	RW
30	52	adj. PLC output 1 (P20)	6	OUT_MEAS_ACT	U16	2	RW
30	52	adj. PLC output 1 (P20)	7	OUT_S3	U16	2	RW
30	52	adj. PLC output 1 (P20)	8	OUT_S4	U16	2	RW
30	52	adj. PLC output 1 (P20)	9	OUT_S5	U16	2	RW
30	52	adj. PLC output 1 (P20)	10	OUT_S6	U16	2	RW
30	52	adj. PLC output 1 (P20)	11	OUT_TEST_OP	U16	2	RW
30	52	adj. PLC output 1 (P20)	12	OUT_ERROR	U16	2	RW
30	52	adj. PLC output 1 (P20)	13	OUT_WARN_TARE	U16	2	RW
30	52	adj. PLC output 1 (P20)	14	OUT_CONFIG	U16	2	RW
30	52	adj. PLC output 1 (P20)	15	OUT_ACK_ALARM	U16	2	RW
30	52	adj. PLC output 1 (P20)	16	OUT_ACK_LOCK	U16	2	RW
30	52	adj. PLC output 1 (P20)	17	OUT_ACK_OK	U16	2	RW
30	52	adj. PLC output 1 (P20)	18	OUT_ACK_NOK	U16	2	RW
30	52	adj. PLC output 1 (P20)	19	OUT_PC_LOG	U16	2	RW

Slot 30, Indices 53 to 57 (Assignment adjustable PLC outputs 2 to 6)

Slot	Index	Description	Value	Meaning of value	Type	Len	R/W
30	53	adj. PLC output 2 (P21)	<i>see index52</i>		U16	2	RW
30	54	adj. PLC output 3 (P22)	<i>see index52</i>		U16	2	RW
30	55	adj. PLC output 4 (P23)	<i>see index52</i>		U16	2	RW
30	56	adj. PLC output 5 (P24)	<i>see index52</i>		U16	2	RW
30	57	adj. PLC output 6 (P25)	<i>see index52</i>		U16	2	RW

Slot 30, Index 58 (Assignment adjustable PLC input 1)

Slot	Index	Description	Value	Meaning of value	Type	Len	R/W
30	58	adj. PLC input 1 (P4)	0	IN_TARE_X	U16	2	RW
30	58	adj. PLC input 1 (P4)	1	IN_TARE_Y	U16	2	RW
30	58	adj. PLC input 1 (P4)	2	IN_TARE_X+Y	U16	2	RW
30	58	adj. PLC input 1 (P4)	3	IN_RES_STAT	U16	2	RW
30	58	adj. PLC input 1 (P4)	4	IN_STEST	U16	2	RW
30	58	adj. PLC input 1 (P4)	5	IN_TEST_OP	U16	2	RW
30	58	adj. PLC input 1 (P4)	6	IN_ACK	U16	2	RW
30	58	adj. PLC input 1 (P4)	7	IN_ACK_OK	U16	2	RW
30	58	adj. PLC input 1 (P4)	8	IN_ACK_NOK	U16	2	RW
30	58	adj. PLC input 1 (P4)	9	IN_ACK_ERROR	U16	2	RW

Slot 30, Indices 59 to 60 (Assignment adjustable PLC inputs 2 to 3)

Slot	Index	Description	Value	Meaning of value	Type	Len	R/W
30	59	adj. PLC input 2 (P5)	<i>see index 58</i>		U16	2	RW
30	60	adj. PLC input 3 (P6)	<i>see index 58</i>		U16	2	RW

Slot 30, Indices 61 to 71

Slot	Index	Description	Value	Meaning of value	Type	Len	R/W
30	61	Order sheet: Operator	<i>Michael_Mueller</i>		STR 64	64	RW
30	62	Order sheet: Order number	<i>AN_123456</i>		STR 64	64	RW
30	63	Order sheet: Batch	<i>BATCH_257-3</i>		STR 64	64	RW
30	64	Order sheet: Component	<i>Cylinder_right</i>		STR 64	64	RW
30	65	Order sheet: Serial number 1	<i>SN_123456789</i>		STR 64	64	RW
30	66	Order sheet: Serial number 2	<i>SN_987654321</i>		STR 64	64	RW
30	67	Acknowledgement function on/off	0 1	Acknowledgement function off Acknowledgement function on	U16	2	RW
30	68	Acknowledgement function: Acknowledge OK parts on/off	0 1	Not active User has to confirm OK parts (F-Key or PLC input)	U16	2	RW

Slot	Index	Description	Value	Meaning of value	Type	Len	R/W
30	69	Acknowledgement function: Acknowledge NOK parts on/off	0 1	Not active User has to confirm NOK parts (F-Key or PLC input)	U16	2	RW
		Acknowledgement function: Buzzer volume	0 ... 10	10: max. volume			
30	71	Update display (refresh view)	<i>Event!</i>	Writing an arbitrary byte initiates action	U8	1	WO

8.1.2 Communication: Change menu, display update, fault indication (Slot 32)

Slot	Index	Description	Value	Meaning of value	Type	Len	R/W
31	0	Not possible	-	-	x	x	x
31	1 - 9	Reserved	-	-	x	x	x
31	10	Go to menu	0 1	Meas. Menu Graphical test menu	U16	2	WO
			<i>EVENT!</i>	Writing an arbitrary byte initiates action			
31	11	Initiate update of the LCD display	<i>EVENT!</i>	Writing an arbitrary byte initiates action	U8	1	WO
31	12	Device fault status	0x00000001	PREFIX addressing fault	U32	4	RO
			0x00000002	Enquiry received in Device mode	U32	4	RO
			0x00000004	Blockcheck error	U32	4	RO
			0x00000008	Command fault	U32	4	RO
			0x00000010	Parameter error	U32	4	RO
			0x00000020	Timeout Receive Timer	U32	4	RO
			0x00000040	Timeout Response Timer	U32	4	RO
			0x00000080	Invalid ! or ?	U32	4	RO
			0x00000100	Invalid configuration	U32	4	RO
			0x00000400	No valid measurements are available	U32	4	RO
			0x00004000	Reading out the measurement curve was interrupted by the beginning of a new measurement	U32	4	RO
			0x00080000	No TEDS or TEDS is not valid	U32	4	RO
			0x00100000	TEDS voltage too low	U32	4	RO
			0x00200000	TEDS ID not valid	U32	4	RO
			0x00400000	TEDS Version not valid	U32	4	RO
0x00800000	Strain gauge sensor	U32	4	RO			

Slot	Index	Description	Value	Meaning of value	Type	Len	R/W
				connected but another sensor selected			
			0x01000000	Standard signal sensor connected but another sensor selected	U32	4	RO
			0x02000000	Unknown error	U32	4	RO
			0x04000000	Sensor type is not valid	U32	4	RO
			0x08000000	Potentiometer sensor connected but another sensor selected	U32	4	RO
			0x10000000	Direction of strain gauge is not valid	U32	4	RO
			0x20000000	USB Flash Error	U32	4	RO

8.1.3 Program Selection/Renaming & Statistics reset (Slot 32)

Slot	Index	Description	Value	Meaning of value	Type	Len	R/W
32	0	Not possible	-	-	x	x	x
32	1 - 9	Reserved	-	-	x	x	x
32	10	Set program number	0 ... 15		U16	2	RW
32	11	Writing/Reading of the current program name	Program name		STR 20	20	RW
32	12	Reset statistics of a measurement program	0 ... 15	EVENT! Selection through writing the program number	U16	2	WO
32	13	Reset statistics in all measurement programs	EVENT!	Writing an arbitrary byte initiates action	U8	1	WO

8.1.4 General channel settings (Slot 33)

Slot	Index	Description	Value	Meaning of value	Type	Len	R/W
33	0	Not possible	-	-			X
33	1 - 9	Reserved	-	-			X
33	10	Channel settings channel X Note: First make the settings in indices 10, 11 then initiate with index 12!	0 1 2 3 4 5	Terminals: A, Potentiometer A, standard signal B, strain gauge B, standard signal B, Piezo Time	U16	2	RW
33	11	Channel settings channel Y Note: First make the settings in indices 10, 11 then initiate with	0 1 2 3 4	Terminals: A, Potentiometer A, standard signal B, strain gauge B, standard signal B, Piezo	U16	2	RW

Slot	Index	Description	Value	Meaning of value	Type	Len	R/W
		index 12!	5	Time			
33	12	Accept channel settings	<i>Event!</i>	The settings from indices 10, 11 are being stored. Writing an arbitrary byte initiates action.	U8	1	WO
33	13	Filter channel X Note: Not available for the channel settings "Piezo"	0 1 2 3 4 5 6 7 8	Off 5 Hz filter 10 Hz filter 25 Hz filter 50 Hz filter 100 Hz filter 200 Hz filter 400 Hz filter 800 Hz filter	U16	2	RW
33	14	Filter channel Y Notes: Not available for the channel settings "Piezo"	0 1 2 3 4 5 6 7 8	Off 5 Hz filter 10 Hz filter 25 Hz filter 50 Hz filter 100 Hz filter 200 Hz filter 400 Hz filter 800 Hz filter	U16	2	RW
33	15	Transmitter supply channel X Note: Entry is not available for the channel settings "Piezo" Only for 'BlackBox' devices	0 1	Transmitter supply off Transmitter supply on	U16	2	RW
33	16	Transmitter supply channel Y Note: Entry is not available for the channel settings "Piezo" Only for 'BlackBox' devices	0 1	Transmitter supply off Transmitter supply on	U16	2	RW
33	17	Set unit channel X Note: Entry is not available for the channel settings "Time"	0 1 2 3 4 5 6 7 8 9	User defined unit 1 User defined unit 2 User defined unit 3 mm N kN Nm Ncm grd bar	U16	2	RW

Slot	Index	Description	Value	Meaning of value	Type	Len	R/W
			10 11 12	V s ms			
33	18	Set unit channel Y Note: Entry is not available for the channel settings "Time"	0 1 2 3 4 5 6 7 8 9 10 11 12	User defined unit 1 User defined unit 2 User defined unit 3 mm N kN Nm Ncm grd bar V s ms	U16	2	RW
33	19	Set user defined unit 1	<i>abcd</i>		STR 4	4	RW
33	20	Set user defined unit 2	<i>abcd</i>		STR 4	4	RW
33	21	Set user defined unit 3	<i>ijkl</i>		STR 4	4	RW
33	22	Returns the measured value on channel X Note: Entry is not available for the channel settings "Time"	<i>EVENT!</i>		FLT	4	RO
33	23	Returns the measured value on channel Y Note: Entry is not available for the channel settings "Time"	<i>EVENT!</i>		FLT	4	RO
33	24	Channel to be scaled	0 1	Channel X Channel Y	U 16	2	WO
33	25	Lower scale value		Concerns the channel selected under index 24	FLT	4	RW
33	26	Upper scale value		Concerns the channel selected under index 24	FLT	4	RW
33	27	Lower calibration value		Concerns the channel selected under index 24	FLT	4	RW
33	28	Upper calibration value		Concerns the channel selected under index 24	FLT	4	RW
33	29	Perform scaling (as per index 25 ... 29)	<i>EVENT</i>	Entry is not available for the channel settings "Off" and "Time"	U8	1	WO
33	30	Switch between program depending and global channel settings	0 1	Program depending Global Note: If changing to global	U 16	2	RW

Slot	Index	Description	Value	Meaning of value	Type	Len	R/W
				settings, the individual channel setting will get lost			

8.1.5 Channel settings “Standard signal” (Slot 34)

Slot	Index	Description	Value	Meaning of value	Type	Len	R/W
34	0	Not possible	-	-			X
34	1 - 9	Reserved	-	-			X
34	10	Standard signal input channel X	0 1	5 V input range 10 V input range	U16	2	RW
34	11	Standard signal input channel Y	0 1	5 V input range 10 V input range	U16	2	RW

8.1.6 Channel settings “Strain gauge” (Slot 35)

Slot	Index	Description	Value	Meaning of value	Type	Len	R/W
35	0	Not possible	-	-			X
35	1 - 9	Reserved	-	-			X
35	10	Strain gauge input range channel X	0 1 2 3 4	2 mV/V input range 4 mV/V input range 10 mV/V input range 20 mV/V input range 40 mV/V input range	U16	2	RW
35	11	Strain gauge input range channel Y	0 1 2 3 4	2 mV/V input range 4 mV/V input range 10 mV/V input range 20 mV/V input range 40 mV/V input range	U16	2	RW
35	12	Strain gauge sensitivity channel X	0.01 ... 100.0	IEEE754 Float	FLT	4	RW
35	13	Strain gauge sensitivity channel Y	0.01 ... 100.0	IEEE754 Float	FLT	4	RW
35	14	Level (elect.) strain gauge channel X	0.01 ... 100.0	IEEE754 Float	FLT	4	RO
35	15	Level (elect.) strain gauge channel Y	0.01 ... 100.0	IEEE754 Float	FLT	4	RO

8.1.7 Channel settings “Piezo” (Slot 36)

Slot	Index	Description	Value	Meaning of value	Type	Len	R/W
36	0	Not possible	-	-			X
36	1 - 9	Reserved	-	-			X
36	10	Piezo input range channel X	0 1 2 3 4 5 6 7 8 9	1nC range 2nC range 5nC range 10nC range 20nC range 40nC range 80nC range 200nC range 400nC range 1uC range	U16	2	RW
36	11	Piezo input range channel Y	0 1 2 3 4 5 6 7 8 9	1nC range 2nC range 5nC range 10nC range 20nC range 40nC range 80nC range 200nC range 400nC range 1uC range	U16	2	RW
36	12	Piezo short-circuit on/to channel X	0 1	Do not short-circuit piezo input Short-circuit piezo input	U16	2	WO
36	13	Piezo short-circuit on/to channel Y	0 1	Do not short-circuit piezo input Short-circuit piezo input	U16	2	WO

8.1.8 Tare (Slot 37)

Slot	Index	Description	Value	Meaning of value	Type	Len	R/W
37	0	Not possible	-	-			X
37	1 .. 9	Reserved	-	-			X
37	10	Tare at meas. start channel X	0 1	off on	U16	2	RW
37	11	Tare at meas. start channel Y	0 1	off on	U16	2	RW
37	12	Standard value for tare channel X	<i>between -9999999.0 and 9999999.0</i>	Float value, Float according to IEEE754	FLT	4	RW
37	13	Standard value for tare channel Y	<i>between -9999999.0 and 9999999.0</i>	Float value, Float according to IEEE754	FLT	4	RW
37	14	Tare warning on/off channel X	0 1	off on	U16	2	RW

Slot	Index	Description	Value	Meaning of value	Type	Len	R/W
37	15	Tare warning on/off channel Y	0 1	off on	U16	2	RW
37	16	Set tare warning limit channel X	<i>between 1.0 and 20.0</i>	Float value, Float according to IEEE754	FLT	4	RW
37	17	Set tare warning limit channel Y	<i>between 1.0 and 20.0</i>	Float value Float according to IEEE754	FLT	4	RW
37	18	Tare channel X	<i>EVENT!</i>	Writing an arbitrary byte initiates action	U8	1	WO
37	19	Delete tare channel X	<i>EVENT!</i>	Writing an arbitrary byte initiates action	U8	1	WO
37	20	Tare channel Y	<i>EVENT!</i>	Writing an arbitrary byte initiates action	U8	1	WO
37	21	Delete tare channel Y	<i>EVENT!</i>	Writing an arbitrary byte initiates action	U8	1	WO

8.1.9 Measurement mode (Slot 38)

Slot	Index	Description	Value	Meaning of value	Type	Len	R/W
38	0	Not possible	-	-			X
38	1 .. 9	Reserved	-	-			X
38	10	X sampling off/on	0 1	off on	U16	2	RW
38	11	X sample rate	<i>between 0.0 and 9999999.0</i>	Float value Float according to IEEE754	FLT	4	RW
38	12	Y sampling off/on	0 1	off on	U16	2	RW
38	13	Y sample rate	<i>between 0.0 and 9999999.0</i>	Float value Float according to IEEE754	FLT	4	RW
38	14	Time sampling off/on	0 1	off on	U16	2	RW
38	15	Time sample rate	<i>between 0.0 and 9999999.0</i>	Float value Float according to IEEE754	FLT	4	RW
38	16	Set reference of curve Note: "Underrun" is not permitted if the channel concerned is set to time.	0 1 2 3 4 5	Absolute Final force Y reference line overrun Y reference line underrun Y trigger overrun Y trigger underrun	U16	2	RW
38	17	Set reference line Y	<i>between -9999999.0 and 9999999.0</i>	Float value Float according to IEEE754	FLT	4	RW
38	18	Set trigger line Y	<i>between -9999999.0 and 9999999.0</i>	Float value Float according to IEEE754	FLT	4	RW

Slot	Index	Description	Value	Meaning of value	Type	Len	R/W
38	19	Set return point	0	XMIN	U16	2	RW
			1	XMAX			
			2	YMIN			
			3	YMAX			
38	20	Set "Record curve to"	0	Complete curve	U16	2	RW
			1	Up to return point			
38	21	Set start mode	0	External	U16	2	RW
			1	X internal overrun			
			2	X internal underrun			
			3	Y internal overrun			
38	22	Set stop mode	0	External	U16	2	RW
			1	X internal overrun			
			2	X internal underrun			
			3	Y internal overrun			
38	23	Set X start value for internal start	0	External	U16	2	RW
			1	X internal overrun			
			2	X internal underrun			
			3	Y internal overrun			
38	24	Set Y start value for internal start	0	External	U16	2	RW
			1	X internal overrun			
			2	X internal underrun			
			3	Y internal overrun			
38	25	Set X stop value for internal stop	0	External	U16	2	RW
			1	X internal overrun			
			2	X internal underrun			
			3	Y internal overrun			
38	26	Set Y stop value for internal stop	0	External	U16	2	RW
			1	X internal overrun			
			2	X internal underrun			
			3	Y internal overrun			
38	27	Set the "stop" timeout value	0	External	U16	2	RW
			1	X internal overrun			
			2	X internal underrun			
			3	Y internal overrun			
38	28	Set the "stop" number of measured values	0	External	U16	2	RW
			1	X internal overrun			
			2	X internal underrun			
			3	Y internal overrun			

8.1.10 Evaluation window 1 (Slot 39)

Slot	Index	Description	Value	Meaning of value	Type	Len	R/W
39	0	Not possible	-	-			X
39	1 .. 9	Reserved	-	-			X
39	10	Window 1 off/on	0	off	U16	2	RW
			1	on			
39	11	Window 1 limit Xmin	between -9999999.0	Float value Float according to IEEE754	FLT	4	RW

Slot	Index	Description	Value	Meaning of value	Type	Len	R/W
		Note: At the end, entry must be adopted through index 15.	<i>and</i> 9999999.0				
39	12	Window 1 limit Xmax Note: At the end, entry must be adopted through index 15.	<i>between</i> -9999999.0 <i>and</i> 9999999.0	Float value Float according to IEEE754	FLT	4	RW
39	13	Window 1 limit Ymin Note: At the end, entry must be adopted through index 15.	<i>between</i> -9999999.0 <i>and</i> 9999999.0	Float value Float according to IEEE754	FLT	4	RW
39	14	Window 1 limit Ymax Note: At the end, entry must be adopted through index 15	<i>between</i> -9999999.0 <i>and</i> 9999999.0	Float value Float according to IEEE754	FLT	4	RW
39	15	Window 1 copy limit Note: Values entered into indices 11, 12, 13, 14 are adopted	<i>EVENT!</i>	Writing an arbitrary byte initiates action	U8	1	WO
39	16	Window 1 entry left Note: At the end, entry must be adopted through index 24.	0 1	no yes	U16	2	RW
39	17	Window 1 entry right Note: At the end, entry must be adopted through index 24.	0 1	no yes	U16	2	RW
39	18	Window 1 entry bottom Note: At the end, entry must be adopted through index 24.	0 1	no yes	U16	2	RW
39	19	Window 1 entry top Note: At the end, entry must be adopted through index 24.	0 1	no yes	U16	2	RW
39	20	Window 1 exit left Note: At the end, entry must be adopted through index 24.	0 1	no yes	U16	2	RW
39	21	Window 1 exit right Note: At the end, entry must be adopted through index 24.	0 1	no yes	U16	2	RW

Slot	Index	Description	Value	Meaning of value	Type	Len	R/W
39	22	Window 1 exit bottom Note: At the end, entry must be adopted through index 24.	0 1	no yes	U16	2	RW
39	23	Window 1 exit top Note: At the end, entry must be adopted through index 24.	0 1	no yes	U16	2	RW
39	24	Copy window entry/exit Note: Values entered into indices 16 - 23 are adopted	<i>EVENT!</i>	no yes	U8	1	WO
39	25	Window 1 curve segment for evaluation	0 1 2	Forward Return Complete curve	U16	2	RW
39	26	Window 1 online evaluation	0 1 2 3 4	Off left - right right - left bottom - top top - bottom	U16	2	RW
39	27	Window 1 Online signal level	0 1	Low active High active	U16	2	RW

8.1.11 Evaluation window 2 (Slot 40)

Slot	Index	Description	Value	Meaning of value	Type	Len	R/W
40	0	Not possible	-	-			X
40	1 .. 9	Reserved	-	-			X
40	10 ...	See slot 39					

8.1.12 Evaluation window 3 (Slot 41)

Slot	Index	Description	Value	Meaning of value	Type	Len	R/W
41	0	Not possible	-	-			X
41	1 .. 9	Reserved	-	-			X
41	10 ...	See slot 39					

8.1.13 Evaluation trapezoid window 1 (Slot 42)

Slot	Index	Description	Value	Meaning of value	Type	Len	R/W
42	0	Not possible	-	-			X
42	1 .. 9	Reserved	-	-			X
42	10	Trapezoid 1 off/on	0 1	off on	U16	2	RW
42	11	Trapezoid type X/Y	0 1	Type X-Trapezoid Type Y-Trapezoid			
42	12	Trapezoid 1 limit Type X: Xmin Type Y: Ymin Note: At the end, entry must be adopted through index 18	<i>between</i> -9999999.0 <i>and</i> 9999999.0	Float value Float according to IEEE754	FLT	4	RW
42	13	Trapezoid 1 limit Type X: Xmax Type Y: Ymax Note: At the end, entry must be adopted through index 18.	<i>between</i> -9999999.0 <i>and</i> 9999999.0	Float value Float according to IEEE754	FLT	4	RW
42	14	Trapezoid 1 limit Type X: Ymin left Type Y: Xmin bottom Note: At the end, entry must be adopted through index 18.	<i>between</i> -9999999.0 <i>and</i> 9999999.0	Float value Float according to IEEE754	FLT	4	RW
42	15	Trapezoid 1 limit Type X: Ymax left Type Y: Xmax bottom Note: At the end, entry must be adopted through index 18.	<i>between</i> -9999999.0 <i>and</i> 9999999.0	Float value Float according to IEEE754	FLT	4	RW
42	16	Trapezoid 1 limit Type X: Ymin right Type Y: Xmin top Note: At the end, entry must be adopted through index 18.	<i>between</i> -9999999.0 <i>and</i> 9999999.0	Float value Float according to IEEE754	FLT	4	RW

Slot	Index	Description	Value	Meaning of value	Type	Len	R/W
42	17	Trapezoid 1 limit Type X: Ymax right Type Y: Xmax top Note: At the end, entry must be adopted through index 18.	<i>between -9999999.0 and 9999999.0</i>	Float value Float according to IEEE754	FLT	4	RW
42	18	Trapezoid 1 copy the limits Note: Values entered into indices 12 - 17 are adopted	<i>EVENT</i>	Writing an arbitrary byte initiates action	U8	1	WO
42	19	Trapezoid 1 entry Type X: entry left Type Y: entry bottom Note: At the end, entry must be adopted through index 23.	<i>0 1</i>	no yes	U16	2	RW
42	20	Trapezoid 1 entry Type X: entry right Type Y: entry top Note: At the end, entry must be adopted through index 23.	<i>0 1</i>	no yes	U16	2	RW
42	21	Trapezoid 1 exit Type X: exit left Type Y: exit bottom Note: At the end, entry must be adopted through index 23	<i>0 1</i>	no yes	U16	2	RW
42	22	Trapezoid 1 exit Type X: exit right Type Y: exit top Note: At the end, entry must be adopted through index 23	<i>0 1</i>	no yes	U16	2	RW
42	23	Trapezoid 1 copy entry/exit Note: Values entered into indices 19- 22 are adopted.	<i>EVENT</i>	Writing an arbitrary byte initiates action	U8	1	WO
42	24	Trapezoid 1 curve	<i>0</i>	Forward	U16	2	RW

Slot	Index	Description	Value	Meaning of value	Type	Len	R/W
		segment for evaluation	1 2	Return Complete curve			

8.1.14 Evaluation trapezoid window 2 (Slot 43)

Slot	Index	Description	Value	Meaning of value	Type	Len	R/W
43	0	Not possible	-	-			X
43	1 .. 9	Reserved	-	-			X
43	10 ...	See slot 42					

8.1.15 Evaluation threshold 1 (Slot 44)

Slot	Index	Description	Value	Meaning of value	Type	Len	R/W
44	0	Not possible	-	-			X
44	1 .. 9	Reserved	-	-			X
44	10	Threshold 1 off/on	0 1	off on	U16	2	RW
44	11	Threshold 1 type of threshold	0 1	Type X (vertical) Type Y (horizontal)	U16	2	RW
44	12	Threshold 1 position Type X: X value Type Y: Y value Note: At the end, entry must be adopted through index 15.	<i>between</i> -9999999.0 <i>and</i> 9999999.0	Float value Float according to IEEE754	FLT	4	RW
44	13	Threshold 1 limit Type X: Ymin Type Y: Xmin Note: At the end, entry must be adopted through index 15.	<i>between</i> -9999999.0 <i>and</i> 9999999.0	Float value Float according to IEEE754	FLT	4	RW
44	14	Threshold 1 limit Type X: Ymax Type Y: Xmax Note: At the end, entry must be adopted through index 15.	<i>between</i> -9999999.0 <i>and</i> 9999999.0	Float value Float according to IEEE754	FLT	4	RW
44	15	Threshold 1 copy position and limits Note: Values entered into indices 11 - 14 are	<i>EVENT</i>	Writing an arbitrary byte initiates action	U8	1	WO

Slot	Index	Description	Value	Meaning of value	Type	Len	R/W
		adopted					
44	16	Threshold 1 passage Type X: left > right Type Y: bottom > top Note: At the end, entry must be adopted through index 18.	0 1	no yes	U16	2	RW
44	17	Threshold 1 passage Type X: right > left Type Y: top > bottom Note: At the end, entry must be adopted through index 18.	0 1	no yes	U16	2	RW
44	18	Threshold 1 Copy passage Note: Values entered into indices 16 - 17 are adopted	<i>EVENT</i>	Writing an arbitrary byte initiates action	U8	1	WO
44	19	Threshold 1 Curve segment for evaluation	0 1 2	Forward Return Complete curve	U16	2	RW

8.1.16 Evaluation threshold 2 (Slot 45)

Slot	Index	Description	Value	Meaning of value	Type	Len	R/W
45	0	Not possible	-	-			X
45	1 .. 9	Reserved	-	-			X
45	10 ...	See slot 44					

8.1.17 Evaluation envelope (Slot 46 to 50)

Slot/index data on request

8.1.18 Tolerance band for evaluation elements (Slot 51)

Slot	Index	Description	Value	Meaning of value	Type	Len	R/W
51	0	Not possible	-	-			X
51	1 .. 9	Reserved	-	-			X
51	10	Tolerance band X Note: At the end, entry must be adopted through index 12.	<i>between 0.0 and 9999999.0</i>	Float value Float according to IEEE754	FLT	4	RW
51	11	Tolerance band Y Note: At the end, entry must be adopted through index 12.	<i>between 0.0 and 9999999.0</i>	Float value Float according to IEEE754	FLT	4	RW
51	12	Store tolerance bands Note: Values entered into indices 10 - 11 are adopted.	<i>EVENT</i>	Writing an arbitrary byte initiates action	U8	1	WO

8.1.19 Realtime switchpoints S1 (Slot 52)

Slot	Index	Description	Value	Meaning of value	Type	Len	R/W
52	0	Not possible	-	-			X
52	1 .. 9	Reserved	-	-			X
52	10	Switchpoint S1 value Note: At the end, entry must be adopted through index 14.	<i>between -9999999.0 and 9999999.0</i>	Float value Float according to IEEE754	FLT	4	RW
52	11	Switchpoint S1 channel Note: At the end, entry must be adopted through index 14.	<i>0 1</i>	Channel X Channel Y	U16	2	RW
52	12	Switchpoint S1 level Note: At the end, entry must be adopted through index 14.	<i>0 1</i>	Low active High active	U16	2	RW
52	13	Switchpoint 1 reference Note: At the end, entry must be adopted through index 14.	<i>0 1</i>	Absolute reference Trigger reference	U16	2	RW
52	14	Switchpoint 1 Copy settings	<i>EVENT</i>	Writing an arbitrary byte initiates action	U8	1	WO

Slot	Index	Description	Value	Meaning of value	Type	Len	R/W
		Note: Values entered into indices 10 - 13 are adopted.					

8.1.20 Realtime switchpoints S2 (Slot 53)

Slot	Index	Description	Value	Meaning of value	Type	Len	R/W
53	0	Not possible	-	-			X
53	1 .. 9	Reserved	-	-			X
53	10..	See slot 52					

8.1.21 Realtime switchpoints S3 (Slot 54)

Slot	Index	Description	Value	Meaning of value	Type	Len	R/W
54	0	Not possible	-	-			X
54	1 .. 9	Reserved	-	-			X
54	10..	See slot 52					

8.1.22 Realtime switchpoints S4 (Slot 55)

Slot	Index	Description	Value	Meaning of value	Type	Len	R/W
55	0	Not possible	-	-			X
55	1 .. 9	Reserved	-	-			X
55	10..	See slot 52					

8.1.23 Realtime switchpoints S5 (Slot 56)

Slot	Index	Description	Value	Meaning of value	Type	Len	R/W
56	0	Not possible	-	-			X
56	1 .. 9	Reserved	-	-			X
56	10..	See slot 52					

8.1.24 Realtime switchpoints S6 (Slot 57)

Slot	Index	Description	Value	Meaning of value	Type	Len	R/W
57	0	Not possible	-	-			X
57	1 .. 9	Reserved	-	-			X
57	10..	See slot 52					

8.1.25 Sensortest (Slot 58)

Slot	Index	Description	Value	Meaning of value	Type	Len	R/W
58	0	Not possible	-	-			X
58	1 .. 9	Reserved	-	-			X
58	10	Sensor test Channel X on/off	0 1	off on	U16	2	RW
58	11	Sensor test Channel Y on/off	0 1	off on	U16	2	RW
58	12	Sensor test Channel X measure reference value	<i>EVENT</i>	Writing an arbitrary byte initiates action	U8	1	WO
58	13	Sensor test Channel Y measure reference value	<i>EVENT</i>	Writing an arbitrary byte initiates action	U8	1	WO
58	14	Sensor test Channel X reference value	<i>between -9999999.0 and 9999999.0</i>	Float value Float according to IEEEE754	FLT	4	RW
58	15	Sensor test Channel Y reference value	<i>between -9999999.0 and 9999999.0</i>	Float value Float according to IEEEE754	FLT	4	RW
58	16	Sensor test Channel X tolerance	<i>between 0.0 and 9999999.0</i>	Float value Float according to IEEEE754	FLT	4	RW
58	17	Sensor test Channel Y tolerance	<i>between 0.0 and 9999999.0</i>	Float value Float according to IEEEE754	FLT	4	RW
58	18	Initiate sensor test Note: Read access initiates the sensor test and delivers the result.	0 1	NOK OK	U16	2	RO

8.1.26 Setup user-defined values (Slot 59)

Slot	Index	Description	Value	Meaning of value	Type	Len	R/W
59	0	Not possible	-	-			X
59	1 .. 9	Reserved	-	-			X
59	10	User-defined values value 1	<i>Integer value</i>	See operand table in appendix	U16	2	RW
59	11	User-defined values value 2	<i>Integer value</i>	See operand table in appendix	U16	2	RW
59	12	User-defined values value 3	<i>Integer value</i>	See operand table in appendix	U16	2	RW
59	13	User-defined values value 4	<i>Integer value</i>	See operand table in appendix	U16	2	RW
59	14	User-defined values value 5	<i>Integer value</i>	See operand table in appendix	U16	2	RW
59	15	User-defined values value 6	<i>Integer value</i>	See operand table in appendix	U16	2	RW
59	16	User-defined values value 7	<i>Integer value</i>	See operand table in appendix	U16	2	RW
59	17	User-defined values value 8	<i>Integer value</i>	See operand table in appendix	U16	2	RW
59	18	User-defined values value 9	<i>Integer value</i>	See operand table in appendix	U16	2	RW
59	19	User-defined values value 10	<i>Integer value</i>	See operand table in appendix	U16	2	RW
59	20	User-defined values value 11	<i>Integer value</i>	See operand table in appendix	U16	2	RW
59	21	User-defined values value 12	<i>Integer value</i>	See operand table in appendix	U16	2	RW
59	22	User-defined values value 13	<i>Integer value</i>	See operand table in appendix	U16	2	RW
59	23	User-defined values value 14	<i>Integer value</i>	See operand table in appendix	U16	2	RW
59	24	User-defined values value 15	<i>Integer value</i>	See operand table in appendix	U16	2	RW
59	25	User-defined values value 16	<i>Integer value</i>	See operand table in appendix	U16	2	RW
59	26	User-defined values value 17	<i>Integer value</i>	See operand table in appendix	U16	2	RW
59	27	User-defined values value 18	<i>Integer value</i>	See operand table in appendix	U16	2	RW
59	28	User-defined values value 19	<i>Integer value</i>	See operand table in appendix	U16	2	RW
59	29	User-defined values value 20	<i>Integer value</i>	See operand table in appendix	U16	2	RW

8.1.27 Copy/initialize measurement programs (Slot 60)

Slot	Index	Description	Value	Meaning of value	Type	Len	R/W
60	0	Not possible	-	-		X	X
60	1 .. 9	Reserved	-	-		X	X
60	10	Meas. program number source Note: The settings from indices 10 - 12 are being adopted through indices 13, 14 or 15.	0 ... 15		U16	2	WO
60	11	Meas. program number Target start Note: The settings from indices 10 - 12 are being adopted through indices 13, 14 or 15.	0 ... 15		U16	2	WO
60	12	Meas. program number Target end Note: The settings from indices 10 - 12 are being adopted through indices 13, 14 or 15.	0 ... 15		U16	2	WO
60	13	Copy whole program setup Note: Copy according to entries in indices 10 - 12.	<i>EVENT</i>	Writing an arbitrary byte initiates action	U8	1	WO
60	14	Copy sensor setup Note: Copy according to entries in indices 10 - 12.	<i>EVENT</i>	Writing an arbitrary byte initiates action	U8	1	WO
60	15	Initialize selected programs Note: Initializing according to indices 11 - 12.	<i>EVENT</i>	Writing an arbitrary byte initiates action	U8	1	WO
60	16	Initialize all measurement programs and device parameters	<i>EVENT</i>	Writing an arbitrary byte initiates action	U8	1	WO

8.1.28 Reference curve (Slot 61 to 63)

Slot/index data on request

8.1.29 Test operation (Slot 64)

Slot	Index	Description	Value	Meaning of value	Type	Len	R/W
64	0	Not possible					
64	1...9	Reserved					
64	10	Current measurement value channel X	<i>Float value</i>	Float according to IEEE754	FLT	4	RO
64	11	Current measurement value channel Y	<i>Float value</i>	Float according to IEEE754	FLT	4	RO

8.1.30 Zoom and autoscale (Slot 65)

Slot	Index	Description	Value	Meaning of value	Type	Len	R/W
65	0	Not possible	-	-		X	X
65	1...9	Reserved	-	-		X	X
65	10	Switching autoscale/fix scale	0 1	Autoscale off Autoscale on	U16	2	RW
65	11	Fix scale Xmin Note: At the end, entry must be adopted through index 15.	<i>Float value</i>	Float according to IEEE754	FLT	4	RW
65	12	Fix scale Xmax Note: At the end, entry must be adopted through index 15.	<i>Float value</i>	Float according to IEEE754	FLT	4	RW
65	13	Fix scale Ymin Note: At the end, entry must be adopted through index 15.	<i>Float value</i>	Float according to IEEE754	FLT	4	RW
65	14	Fix scale Ymax Note: At the end, entry must be adopted through index 15.	<i>Float value</i>	Float according to IEEE754	FLT	4	RW
65	15	Store fix scale Note: Values entered into indices 11 - 14 are adopted.	<i>EVENT!</i>	Writing an arbitrary byte initiates action	U8	1	WO

8.1.31 USB-Logging (Slot 66)

Slot	Index	Description	Value	Meaning of value	Type	Len	R/W
66	0	Not possible	-	-		X	X
66	1...9	Reserved	-	-		X	X
66	10	USB-Logging on/off	0 1	off on	U16	2	RW
66	11	Designation of file name	0 1	Program name Order sheet	U16	2	RW
66	12	State of USB-Drive	0 1 2 3	State couldn't be read Not attached Attached but not mounted Attached and mounted	U16	2	RO
66	13	Free space on USB-Drive	String	If USB Drive is not attached or not mounted (see index 12) "0,000 MB" will be returned	STR 15	15	RO
66	14	Format USB Drive	String "formatusb"	"formatusb" works as a password here	STR 9	9	WO
66	15	READY-Control	0 1	off on	U16	2	RW

8.1.32 TEDS-Sensors (Slot 67)

Slot	Index	Description	Value	Meaning of value	Type	Len	R/W
67	0	Not possible	-	-		X	X
67	1...9	Reserved	-	-		X	X
67	10	Connector	0 1	A B	U16	2	WO
67	11	Direction Note: applicable for strain gauge sensors only	0 1	Preferred direction Against preferred direction	U16	2	WO
67	12	Read TEDS electronic data sheet from Connector specified at Index 10 with measurement direction according to Index11	EVENT!	Writing an arbitrary byte initiates action	U8	1	WO

8.1.33 Reserved slots (Slots 68...78)

Slot	Index	Description	Value	Meaning of value	Type	Len	R/W
68... 78	XX	Not possible	-	-	X	X	X

8.2 Measurement results

8.2.1 Status of measurement (Slot 79)

Slot	Index	Description	Value	Meaning of value	Type	Len	R/W
79	0	Not possible	-	-		X	X
79	1...9	Reserved				X	X
79	10	Index of the last measured value of the current curve Caution: The number of the pair of values is shown on the display. The index begins at 0, the number at 1!	<i>16 Bit Integer value</i>	0 means that there is no measurement curve	U16	2	RO
79	11	Running measurement curve counter [only relevant for Digicontrol usage]	<i>32 Bit Integer value</i>	This counter is incremented by 1 when a measurement curve is newly acquired in any menu	U32	4	RO
79	12	Amount of curves in current array of curves	<i>0...10</i>	Integer value between 0 and 10	U16	2	RO

8.2.2 Further information for current measurement curve (Slot 80)

Slot	Index	Description	Value	Meaning of value	Type	Len	R/W
80	0	Not possible	-	-		X	X
80	1...9	Reserved	-	-		X	X
80	10	Piece Counter	<i>32 Bit Integer value</i>		U32	4	RO
80	11	NOK counter (sum)	<i>32 Bit Integer value</i>		U32	4	RO
80	12	Total evaluation	<i>0 1</i>	NOK OK	U16	2	RO
80	13	Index of the curve's return point Caution: The number of the pair of values is shown on the display. The index begins at 0, the number at 1!	<i>16 Bit Integer value</i>		U16	2	RO
80	14	Index of the last measured value of the curve Caution: The number of the pair of values is shown on the display. The index begins at 0,	<i>16 Bit Integer value</i>		U16	2	RO

Slot	Index	Description	Value	Meaning of value	Type	Len	R/W
		the number at 1!					
80	15	Status overdrive of the A/D converter	0 1	No overdrive Overdrive	U16	2	RO
80	16	Date of recording	<i>String in format dd.mm.yyyy</i>		STR 10	10	RO
80	17	Time of recording hh:mm:ss	<i>String in format hh:mm:ss</i>		STR 8	8	RO
80	18	Unit channel X	<i>String with max. 4 characters, e.g. "N" or "inch"</i>		STR 4	4	RO
80	19	Unit channel Y	<i>String with max. 4 characters, e.g. "N" or "inch"</i>		STR 4	4	RO

8.2.3 General curve data (Slot 81)

Slot	Index	Description	Value	Meaning of value	Type	Len	R/W
81	0	Not possible	-	-		X	X
81	1...9	Reserved	-	-		X	X
81	10	X-minimum, X-coordinate	<i>Float value</i>	Float according to IEEE754	FLT	4	RO
81	11	X-minimum, Y-coordinate	<i>Float value</i>	Float according to IEEE754	FLT	4	RO
81	12	X-maximum, X-coordinate	<i>Float value</i>	Float according to IEEE754	FLT	4	RO
81	13	X-maximum, Y-coordinate	<i>Float value</i>	Float according to IEEE754	FLT	4	RO
81	14	Y-minimum, X-coordinate	<i>Float value</i>	Float according to IEEE754	FLT	4	RO
81	15	Y-minimum, Y-coordinate	<i>Float value</i>	Float according to IEEE754	FLT	4	RO
81	16	Y-maximum, X-coordinate	<i>Float value</i>	Float according to IEEE754	FLT	4	RO
81	17	Y-maximum, Y-coordinate	<i>Float value</i>	Float according to IEEE754	FLT	4	RO
81	18	First value X-coordinate	<i>Float value</i>	Float according to IEEE754	FLT	4	RO
81	19	First value Y-coordinate	<i>Float value</i>	Float according to IEEE754	FLT	4	RO
81	20	Last value X-coordinate	<i>Float value</i>	Float according to IEEE754	FLT	4	RO
81	21	Last value Y-coordinate	<i>Float value</i>	Float according to IEEE754	FLT	4	RO

Slot	Index	Description	Value	Meaning of value	Type	Len	R/W
81	22	Return point X-coordinate	<i>Float value</i>	Float according to IEEE754	FLT	4	RO
81	23	Return point Y-coordinate	<i>Float value</i>	Float according to IEEE754	FLT	4	RO

8.2.4 Request measurement results of user-defined values (Slot 82)

Slot	Index	Description	Value	Meaning of value	Type	Len	R/W
82	0	Not possible	-	-		X	X
82	1...9	Reserved	-	-		X	X
82	10	User-defined value 1 name	<i>String with the designator of the value</i>	Designator = "0" means that no value is defined for this value number	STR 16	16	RO
82	11	User-defined value 1 measurement value	<i>Float value</i>	Float according to IEEE754	FLT	4	RO
82	12	User-defined value 1 unit	<i>String with max. 4 characters, e.g. "N" or "inch"</i>	See operand table in appendix.	STR 4	4	RO
82	13	User-defined value 2 name	<i>String with the designator of the value</i>	Designator = "0" means that no value is defined for this value number	STR 16	16	RO
82	14	User-defined value 2 measurement value	<i>Float value</i>	Float according to IEEE754	FLT	4	RO
82	15	User-defined value 2 unit	<i>String with max. 4 characters, e.g. "N" or "inch"</i>	See operand table in appendix.	STR 4	4	RO
82	16	User-defined value 3 name	<i>String with the designator of the value</i>	Designator = "0" means that no value is defined for this value number	STR 16	16	RO
82	17	User-defined value 3 measurement value	<i>Float value</i>	Float according to IEEE754	FLT	4	RO
82	18	User-defined value 3 unit	<i>String with max. 4 characters, e.g. "N" or "inch"</i>	See operand table in appendix.	STR 4	4	RO
82	19	User-defined value 4 name	<i>String with the designator of the value</i>	Designator = "0" means that no value is defined for this value number	STR 16	16	RO
82	20	User-defined value 4 measurement value	<i>Float value</i>	Float according to IEEE754	FLT	4	RO
82	21	User-defined value 4 unit	<i>String with max. 4</i>	See operand table in appendix.	STR 4	4	RO

Slot	Index	Description	Value	Meaning of value	Type	Len	R/W
			<i>characters, e.g. "N" or "inch"</i>				
82	22	User-defined value 5 name	<i>String with the designator of the value</i>	Designator = "0" means that no value is defined for this value number	STR 16	16	RO
82	23	User-defined value 5 measurement value	<i>Float value</i>	Float according to IEEE754	FLT	4	RO
82	24	User-defined value 5 unit	<i>String with max. 4 characters, e.g. "N" or "inch"</i>	See operand table in appendix.	STR 4	4	RO
82	25	User-defined value 6 name	<i>String with the designator of the value</i>	Designator = "0" means that no value is defined for this value number	STR 16	16	RO
82	26	User-defined value 6 measurement value	<i>Float value</i>	Float according to IEEE754	FLT	4	RO
82	27	User-defined value 6 unit	<i>String with max. 4 characters, e.g. "N" or "inch"</i>	See operand table in appendix.	STR 4	4	RO
82	28	User-defined value 7 name	<i>String with the designator of the value</i>	Designator = "0" means that no value is defined for this value number	STR 16	16	RO
82	29	User-defined value 7 measurement value	<i>Float value</i>	Float according to IEEE754	FLT	4	RO
82	30	User-defined value 7 unit	<i>String with max. 4 characters, e.g. "N" or "inch"</i>	See operand table in appendix.	STR 4	4	RO
82	31	User-defined value 8 name	<i>String with the designator of the value</i>	Designator = "0" means that no value is defined for this value number	STR 16	16	RO
82	32	User-defined value 8 measurement value	<i>Float value</i>	Float according to IEEE754	FLT	4	RO
82	33	User-defined value 8 unit	<i>String with max. 4 characters, e.g. "N" or "inch"</i>	See operand table in appendix.	STR 4	4	RO
82	34	User-defined value 9 name	<i>String with the designator of the value</i>	Designator = "0" means that no value is defined for this value number	STR 16	16	RO
82	35	User-defined value 9 measurement value	<i>Float value</i>	Float according to IEEE754	FLT	4	RO

Slot	Index	Description	Value	Meaning of value	Type	Len	R/W
82	36	User-defined value 9 unit	<i>String with max. 4 characters, e.g. "N" or "inch"</i>	See operand table in appendix.	STR 4	4	RO
82	37	User-defined value 10 name	<i>String with the designator of the value</i>	Designator = "0" means that no value is defined for this value number	STR 16	16	RO
82	38	User-defined value 10 measurement value	<i>Float value</i>	Float according to IEEE754	FLT	4	RO
82	39	User-defined value 10 unit	<i>String with max. 4 characters, e.g. "N" or "inch"</i>	See operand table in appendix.	STR 4	4	RO
82	40	User-defined value 11 name	<i>String with the designator of the value</i>	Designator = "0" means that no value is defined for this value number	STR 16	16	RO
82	41	User-defined value 11 measurement value	<i>Float value</i>	Float according to IEEE754	FLT	4	RO
82	42	User-defined value 11 unit	<i>String with max. 4 characters, e.g. "N" or "inch"</i>	See operand table in appendix.	STR 4	4	RO
82	43	User-defined value 12 name	<i>String with the designator of the value</i>	Designator = "0" means that no value is defined for this value number	STR 16	16	RO
82	44	User-defined value 12 measurement value	<i>Float value</i>	Float according to IEEE754	FLT	4	RO
82	45	User-defined value 12 unit	<i>String with max. 4 characters, e.g. "N" or "inch"</i>	See operand table in appendix.	STR 4	4	RO
82	46	User-defined value 13 name	<i>String with the designator of the value</i>	Designator = "0" means that no value is defined for this value number	STR 16	16	RO
82	47	User-defined value 13 measurement value	<i>Float value</i>	Float according to IEEE754	FLT	4	RO
82	48	User-defined value 13 unit	<i>String with max. 4 characters, e.g. "N" or "inch"</i>	See operand table in appendix.	STR 4	4	RO
82	49	User-defined value 14 name	<i>String with the designator of the value</i>	Designator = "0" means that no value is defined for this value number	STR 16	16	RO

Slot	Index	Description	Value	Meaning of value	Type	Len	R/W
82	50	User-defined value 14 measurement value	<i>Float value</i>	Float according to IEEE754	FLT	4	RO
82	51	User-defined value 14 unit	<i>String with max. 4 characters, e.g. "N" or "inch"</i>	See operand table in appendix.	STR 4	4	RO
82	52	User-defined value 15 name	<i>String with the designator of the value</i>	Designator = "0" means that no value is defined for this value number	STR 16	16	RO
82	53	User-defined value 15 measurement value	<i>Float value</i>	Float according to IEEE754	FLT	4	RO
82	54	User-defined value 15 unit	<i>String with max. 4 characters, e.g. "N" or "inch"</i>	See operand table in appendix.	STR 4	4	RO
82	55	User-defined value 16 name	<i>String with the designator of the value</i>	Designator = "0" means that no value is defined for this value number	STR 16	16	RO
82	56	User-defined value 16 measurement value	<i>Float value</i>	Float according to IEEE754	FLT	4	RO
82	57	User-defined value 16 unit	<i>String with max. 4 characters, e.g. "N" or "inch"</i>	See operand table in appendix.	STR 4	4	RO
82	58	User-defined value 17 name	<i>String with the designator of the value</i>	Designator = "0" means that no value is defined for this value number	STR 16	16	RO
82	59	User-defined value 17 measurement value	<i>Float value</i>	Float according to IEEE754	FLT	4	RO
82	60	User-defined value 17 unit	<i>String with max. 4 characters, e.g. "N" or "inch"</i>	See operand table in appendix.	STR 4	4	RO
82	61	User-defined value 18 name	<i>String with the designator of the value</i>	Designator = "0" means that no value is defined for this value number	STR 16	16	RO
82	62	User-defined value 18 measurement value	<i>Float value</i>	Float according to IEEE754	FLT	4	RO
82	63	User-defined value 18 unit	<i>String with max. 4 characters, e.g. "N" or "inch"</i>	See operand table in appendix.	STR 4	4	RO
82	64	User-defined value 19 name	<i>String with the</i>	Designator = "0" means that no value is defined for this	STR 16	16	RO

Slot	Index	Description	Value	Meaning of value	Type	Len	R/W
			<i>designator of the value</i>	value number			
82	65	User-defined value 19 measurement value	<i>Float value</i>	Float according to IEEE754	FLT	4	RO
82	66	User-defined value 19 unit	<i>String with max. 4 characters, e.g. "N" or "inch"</i>	See operand table in appendix.	STR 4	4	RO
82	67	User-defined value 20 name	<i>String with the designator of the value</i>	Designator = "0" means that no value is defined for this value number	STR 16	16	RO
82	68	User-defined value 20 measurement value	<i>Float value</i>	Float according to IEEE754	FLT	4	RO
82	69	User-defined value 20 unit	<i>String with max. 4 characters, e.g. "N" or "inch"</i>	See operand table in appendix.	STR 4	4	RO

8.2.5 Read-out X-coordinates of current measurement curve (Slot 83)

Note that there are two different ways to read the coordinates of the measurement curve:

- Read complete coordinates with a single array access (Array size up to 20 KB)
- Read unique coordinates in several coordinate groups of up to 200 coordinates each

Sequence to read the complete curve coordinates

- 1 Load the curve into the field bus controller through a write access to index 10.
- 2 Query the index of the last measured value of the curve (→ end of the curve) through a read access to index 10 to know the size of the complete curve array (size = index +1).
- 3 Read the complete coordinate-array with access to index 11 (Array size up to 5000 float values = 20 KB).

Note: Please note that you have to announce the length of the buffer to write the curve coordinates to PLC side buffer. Maximum buffer size required to store 5.000 float coordinates is 20.000 bytes. The device will not send more bytes than you have announced.

Sequence to read the unique curve coordinates

- 1 Load the curve into the field bus controller through a write access to index 10.
- 2 Query the index of the last measured value of the curve (→ end of the curve) through a read access to index 10 to know the size of the complete curve array.
- 3 The curve can now be read out in coordinate groups of up to 200 coordinates each:
 Coordinate group 0: Measured value 0 ... 199
 Coordinate group 1: Measured value 200 ... 399
 Coordinate group 2: Measured value 400 ... 599 ... etc.
- 4 The number of the desired coordinate group is entered through a write access to index 19. Since you want to read the beginning of the curve, enter a 0.

It is now possible to read the coordinate values no. 0 ... 199 (at present you have selected coordinate group 0) at the indices 20 ... 219.

- 5 To access the coordinate group 1 (values 200 ... 399) write 1 to index 19. It is now possible to read curve values no. 200 ... 399 at indices 20 ... 219.
- 6 Follow the same way to read the further coordinate groups.
- 7 Only coordinate values that are smaller than or equal to the number of the last measured value (which was read at index 10) can be read out.

Slot	Index	Description	Value	Meaning of value	Type	Len	R/W
83	0	Not possible	-	-		X	X
83	1...9	Reserved	-	-		X	X
83	10	Write access: If a curve is to be read, it must be prepared through a write access before the curve is first read. Read access: Index of the last	<i>EVENT!</i> <i>Writing any two arbitrary bytes initiates action</i>		U16	2	W_

Slot	Index	Description	Value	Meaning of value	Type	Len	R/W
		coordinate; if 0, there is no curve	<i>Integer value</i> 0...4999		U16	2	R_
83	11	Complete coordinates as float array. Note: Before reading the coordinates perform a write access on index 10 to prepare the curve and a read access on the same index 10 to determine the number of coordinates	<i>Float array of</i> 0...5000 values	Float array according to IEEE754	FLT	0-20.000	RO
83	12...18	Reserved	-	-		X	X
83	19	Write access: Desired group of 200 coordinates. For example, if coordinates 600 ... 799 are to be displayed, there must be a 3 here. Query the maximum number of value pairs under slot 83/10. Read access: Group of 200 coordinates currently displayed.	<i>Integer value</i> 0 ... 24 <i>Integer value</i> 0 ... 24		U16 U16	2 2	W_ R_
83	20	0. coordinate of group of coordinates	<i>Float value</i>	Float according to IEEE754	FLT	4	RO
83	21	1. coordinate of group of coordinates	<i>Float value</i>	Float according to IEEE754	FLT	4	RO
83	22	2. coordinate of group of coordinates	<i>Float value</i>	Float according to IEEE754	FLT	4	RO
83	23	3. coordinate of group of coordinates	<i>Float value</i>	Float according to IEEE754	FLT	4	RO
83
83	217	197. coordinate of group of coordinates	<i>Float value</i>	Float according to IEEE754	FLT	4	RO
83	218	198. coordinate of group of coordinates	<i>Float value</i>	Float according to IEEE754	FLT	4	RO
83	219	199. coordinate of group of coordinates	<i>Float value</i>	Float according to IEEE754	FLT	4	RO

8.2.6 Read-out Y-coordinates of current measurement curve (Slot 84)

Slot	Index	Description	Value	Meaning of value	Type	Len	R/W
84	0	Not possible	-	-		X	X
84	1...9	Reserved	-	-		X	X
84	10...	See slot 83				X	X

8.2.7 Evaluation results window 1 (Slot 85)

Slot	Index	Description	Value	Meaning of value	Type	Len	R/W
85	0	Not possible	-	-		X	X
85	1...9	Reserved	-	-		X	X
85	10	Window 1 evaluation results OK/NOK	0 1	NOK OK	U16	2	RO
85	11	Window 1 NOK counter	<i>32bit-Integer value >= 0</i>		U32	4	RO
85	12	Window 1 entry of curve X-coordinate	<i>Float value</i>	Float according to IEEE754	FLT	4	RO
85	13	Window 1 entry of curve Y-coordinate	<i>Float value</i>	Float according to IEEE754	FLT	4	RO
85	14	Window 1 exit of curve X-coordinate	<i>Float value</i>	Float according to IEEE754	FLT	4	RO
85	15	Window 1 exit of curve Y-coordinate	<i>Float value</i>	Float according to IEEE754	FLT	4	RO
85	16	Window 1 absolute maximum in window X-coordinate	<i>Float value</i>	Float according to IEEE754	FLT	4	RO
85	17	Window 1 absolute maximum in window Y-coordinate	<i>Float value</i>	Float according to IEEE754	FLT	4	RO
85	18	Window 1 absolute minimum in window X-coordinate	<i>Float value</i>	Float according to IEEE754	FLT	4	RO
85	19	Window 1 absolute minimum in window Y-coordinate	<i>Float value</i>	Float according to IEEE754	FLT	4	RO

8.2.8 Evaluation results window 2 (Slot 86)

Slot	Index	Description	Value	Meaning of value	Type	Len	R/W
86	0	Not possible	-	-		X	X
86	1...9	Reserved	-	-		X	X
86	10...	See slot 85				X	X

8.2.9 Evaluation results window 3 (Slot 87)

Slot	Index	Description	Value	Meaning of value	Type	Len	R/W
87	0	Not possible	-	-		X	X
87	1...9	Reserved	-	-		X	X
87	10...	See slot 85				X	X

8.2.10 Evaluation results threshold 1 (Slot 88)

Slot	Index	Description	Value	Meaning of value	Type	Len	R/W
88	0	Not possible	-	-		X	X
88	1...9	Reserved	-	-		X	X
88	10	Threshold 1 evaluation result OK/NOK	0 1	NOK OK	U16	2	RO
88	11	Threshold 1 NOK counter	<i>32bit-Integer value >= 0</i>		U32	4	RO
88	12	Threshold intersection point X-coordinate	<i>Float value</i>	Float according to IEEE754	FLT	4	RO
88	13	Threshold intersection point Y-coordinate	<i>Float value</i>	Float according to IEEE754	FLT	4	RO

8.2.11 Evaluation results threshold 2 (Slot 89)

Slot	Index	Description	Value	Meaning of value	Type	Len	R/W
89	0	Not possible	-	-		X	X
89	1...9	Reserved	-	-		X	X
89	10...	See slot 88				X	X

8.2.12 Evaluation results trapezoid window 1 (Slot 90)

Slot	Index	Description	Value	Meaning of value	Type	Len	R/W
90	0	Not possible	-	-		X	X
90	1...9	Reserved	-	-		X	X
90	10	Trapezoid 1 evaluation result OK/NOK	0 1	NOK OK	U16	2	RO
90	11	Trapezoid 1 NOK counter	<i>32bit-Integer value >= 0</i>		U32	4	RO
90	12	Trapezoid 1 entry coordinate X-coordinate	<i>Float value</i>	Float according to IEEE754	FLT	4	RO
90	13	Trapezoid 1 entry coordinate Y-coordinate	<i>Float value</i>	Float according to IEEE754	FLT	4	RO
90	14	Trapezoid 1 exit coordinate X-coordinate	<i>Float value</i>	Float according to IEEE754	FLT	4	RO
90	15	Trapezoid 1 exit coordinate Y-coordinate	<i>Float value</i>	Float according to IEEE754	FLT	4	RO

8.2.13 Evaluation results trapezoid window 2 (Slot 91)

Slot	Index	Description	Value	Meaning of value	Type	Len	R/W
91	0	Not possible	-	-		X	X
91	1...9	Reserved	-	-		X	X
91	10...	See slot 90				X	X

8.2.14 Evaluation results envelope (Slot 92)

Slot	Index	Description	Value	Meaning of value	Type	Len	R/W
92	0	Not possible	-	-		X	X
92	1...9	Reserved	-	-		X	X
92	10	Envelope 1 evaluation result OK/NOK	0 1	NOK OK	U16	2	RO
92	11	Envelope 1 NOK counter	<i>32bit-Integer value >= 0</i>		U32	4	RO
92	12	Envelope 1 entry coordinate X-coordinate	<i>Float value</i>	Float according to IEEE754	FLT	4	RO
92	13	Envelope 1 entry coordinate Y-coordinate	<i>Float value</i>	Float according to IEEE754	FLT	4	RO

Slot	Index	Description	Value	Meaning of value	Type	Len	R/W
92	14	Envelope 1 exit coordinate X-coordinate	Float value	Float according to IEEE754	FLT	4	RO
92	15	Envelope 1 exit coordinate Y-coordinate	Float value	Float according to IEEE754	FLT	4	RO

8.2.15 Combined results (common curve data and evaluation elements – Slot 93)

Slot	Index	Description	Value	Meaning of value	Type	Len	R/W
93	0	Not possible	-			X	X
93	1...9	Reserved	-			X	X
93	10	Combined results: general curve data Y	<i>The data is bit coded and transmitted as STRUCT.</i> X-minimum, X-coord. (FL) X-minimum, Y-coord. (FL) X-maximum, X-coord. (FL) X-maximum, Y-coord. (FL) Y-minimum, X-coord. (FL) Y-minimum, Y-coord.(FL) Y-maximum, X-coord. (FL) Y-maximum, Y-coord.(FL) First value X-coord. (FL) First value Y-coord. (FL) Last value X-coord. (FL) Last value Y-coord. (FL) Return point X-coord. (FL) Return point Y-coord. (FL)		STRUCT OF FLOATS	56	RO
93	11	Combined results: window 1	<i>The data is bit coded and transmitted as STRUCT.</i> Evaluation result (UINT32): 0: NOK 1: OK Entry X-coordinate (FL) Entry Y-coordinate (FL) Exit X-coordinate (FL) Exit Y-coordinate (FL) Absolute max X-coord. (FL) Absolute max Y- coord.(FL) Absolute min X- coord. (FL) Absolute min Y- coord. (FL) Window Xmin coord. (FL) Window Xmax coord. (FL) Window Ymin coord. (FL) Window Ymax coord. (FL)		STRUCT	52	RO
93	12	Combined results: window 2	See index 11		STRUCT	52	RO
93	13	Combined results: window 3	See index 11		STRUCT	52	RO

Slot	Index	Description	Value	Meaning of value	Type	Len	R/W
93	14	Combined results: threshold 1	<p><i>The data is bit coded and transmitted as STRUCT:</i></p> <p>Evaluation result (UINT32): 0: NOK 1: OK</p> <p>Threshold type (UINT32): 0: Type X-Threshold 1: Type Y-Threshold</p> <p>Threshold pass X (FL) Threshold pass Y (FL) Type X: Position X value (FL) Type Y: Position Y value (FL) Type X: Ymin value (FL) Type Y: Xmin value (FL) Type X: Ymax value (FL) Type Y: Xmax value (FL)</p>		STRUCT	28	RO
93	15	Combined results: threshold 2	<i>See index 14</i>		STRUCT	28	RO
93	16	Combined results: trapezoid window 1	<p><i>The data is bit coded and transmitted as STRUCT:</i></p> <p>Evaluation result (UINT32) 0: NOK 1: OK</p> <p>Threshold type (UINT32) 0: Type X-Trapezoid 1: Type Y-Trapezoid</p> <p>Entry X-coord. (FL) Entry Y-coord. (FL) Exit X-coord. (FL) Exit Y-coord. (FL) Type X: Xmin (FL) Type Y: Ymin (FL) Type X: Xmax (FL) Type Y: Ymax (FL) Type X: Ymin left (FL) Type Y: Xmin bottom (FL) Type X: Ymax left (FL) Type Y: Xmax bottom (FL) Type X: Ymin right (FL) Type Y: Xmin top (FL) Type X: Ymax right (FL) Type Y: Xmax top (FL)</p>		STRUCT	48	RO
93	17	Combined results: trapezoid window 2	<i>See index 16</i>		STRUCT	48	RO
93	18	Combined results: envelope	<p><i>The data is bit coded and transmitted as STRUCT:</i></p> <p>Evaluation result (UINT32): 0: NOK 1: OK</p> <p>Entry X-coordinate (FL) Entry Y-coordinate (FL) Exit X-coordinate (FL)</p>		STRUCT	36	RO

Slot	Index	Description	Value	Meaning of value	Type	Len	R/W
			Exit Y-coordinate (FL) Envelope start (FL) Envelope end (FL) Delta min (FL) Delta max (FL)				

9 Appendix

9.1 Operand table

Number	ID of operand
0	OFF
100	General curve data – Start X
101	General curve data – Start Y
102	General curve data – End X
103	General curve data – End Y
104	General curve data – Abs. Xmax X-coordinate
105	General curve data – Abs. Xmax Y-coordinate
106	General curve data – Abs. Xmin X-coordinate
107	General curve data – Abs. Xmin Y-coordinate
108	General curve data – Abs. Ymax X-coordinate
109	General curve data – Abs. Ymax Y-coordinate
110	General curve data – Abs. Ymin X-coordinate
111	General curve data – Abs. Ymin Y-coordinate
112	General curve data – Return point X-coordinate
113	General curve data – Return point Y-coordinate
200	Window 1 – Entry X
201	Window 1 – Entry Y
202	Window 1 – Exit X
203	Window 1 – Exit Y
204	Window 1 – Abs. minimum X
205	Window 1 – Abs. minimum Y
206	Window 1 – Abs. maximum X
207	Window 1 – Abs. maximum Y
208	Window 1 – Coordinate Xmin
209	Window 1 – Coordinate Xmax

Number	ID of operand
210	Window 1 – Coordinate Ymin
211	Window 1 – Coordinate Ymax
300	Window 2 – Entry X
301	Window 2 – Entry Y
302	Window 2 – Exit X
303	Window 2 – Exit Y
304	Window 2 – Abs. minimum X
305	Window 2 – Abs. minimum Y
306	Window 2 – Abs. maximum X
307	Window 2 – Abs. maximum Y
308	Window 2 – Coordinate Xmin
309	Window 2 – Coordinate Xmax
310	Window 2 – Coordinate Ymin
311	Window 2 – Coordinate Ymax
400	Window 3 – Entry X
401	Window 3 – Entry Y
402	Window 3 – Exit X
403	Window 3 – Exit Y
404	Window 3 – Abs. minimum X
405	Window 3 – Abs. minimum Y
406	Window 3 – Abs. maximum X
407	Window 3 – Abs. maximum Y
408	Window 3 – Coordinate Xmin
409	Window 3 – Coordinate Xmax
410	Window 3 – Coordinate Ymin
411	Window 3 – Coordinate Ymax

Number	ID of operand
500	Trapezoid window 1 – Entry X
501	Trapezoid window 1 – Entry Y
502	Trapezoid window 1 – Exit X
503	Trapezoid window 1 – Exit Y
504	Trapezoid window 1 – Coordinate Type X: Xmin Type Y: Ymin
505	Trapezoid window 1 – Coordinate Type X: Xmax Type Y: Ymax
506	Trapezoid window 1 – Coordinate Type X: Ymin left Type Y: Xmin bottom
507	Trapezoid window 1 – Coordinate Type X: Ymax left Type Y: Xmax bottom
508	Trapezoid window 1 – Coordinate Type X: Ymin right Type Y: Xmin top
509	Trapezoid window 1 – Coordinate Type X: Ymax right Type Y: Xmax top
600	Trapezoid window 2 – Entry X
601	Trapezoid window 2 – Entry Y
602	Trapezoid window 2 – Exit X
603	Trapezoid window 2 – Exit Y
604	Trapezoid window 2 – Coordinate Type X: Xmin Type Y: Ymin
605	Trapezoid window 2 – Coordinate Type X: Xmax Type Y: Ymax
606	Trapezoid window 2 – Coordinate Type X: Ymin left Type Y: Xmin bottom
607	Trapezoid window 2 – Coordinate Type X: Ymax left Type Y: Xmax bottom
608	Trapezoid window 2 – Coordinate Type X: Ymin right Type Y: Xmin top
609	Trapezoid window 2 – Coordinate Type X: Ymax right Type Y: Xmax top

Number	ID of operand
700	Threshold 1 – Pass X
701	Threshold 1 – Pass Y
702	Threshold 1 – Coordinate Type X: Position X value Type Y: Position Y value
703	Threshold 1 – Coordinate Type X: Ymin value Type Y: Xmin value
704	Threshold 1 – Coordinate Type X: Ymax value Type Y: Xmax value
800	Threshold 2 – Pass X
801	Threshold 2 – Pass Y
802	Threshold 2 – Coordinate Type X: Position X value Type Y: Position Y value
803	Threshold 2 – Coordinate Type X: Ymin value Type Y: Xmin value
804	Threshold 2 – Coordinate Type X: Ymax value Type Y: Xmax value
900	Envelope – Entry X
901	Envelope – Entry Y
902	Envelope – Exit X
903	Envelope – Exit Y
904	Envelope – Coordinate Start X
905	Envelope – Coordinate End X

9.2 Error Codes

Error number	Description
0x00000000	PNIO_S_OK No error, write/read successful
0xDE80A000	READ_APPL_ERROR Data could not be read from the device.
0xDE80B000	READ_ACCESS_INVALIDINDEX This index is not specified
0xDE80B200	READ_ACCESS_INVALIDSLOT_SUBSLOT Reading from this slot is not supported Note: Only subslot 1 is supported
0xDE80B600	PNIO_E_IOD_READ_ACCESS_DENIED Read from this Slot/Subslot/Index not allowed
0xDE80B600	PNIO_E_IOD_READ_ACCESS_DENIED
0xDE80C000	READ_RESOURCE_CONSTRAINCONFLICT The requested length is to small (< 2 Bytes)
0xDF80A100	WRITE_APPL_ERROR Data could not be written to the device. Please check your data and data length here.
0xDF80B000	WRITE_ACCESS_INVALIDINDEX This index is not specified
0xDF80B100	WRITE_ACCESS_INVALIDLENGTH Please check the length of the date which can be accepted by the DIGIFORCE 9311
0xDF80B200	WRITE_ACCESS_INVALIDSLOT_SUBSLOT Reading from this slot/subslot is not supported Note: Only subslot 1 is supported
0xDF80B600	WRITE_ACCESS_DENIED Write to this Slot/Subslot/Index not allowed
0xDF80C100	WRITE_RESOURCE_CONSTRAINCONFLICT The length of the data to write is to small (< 2 Bytes)