

OPERATION MANUAL

DIGISTANT® 4420-V001

© 2014 burster
präzisionsmesstechnik gmbh & co kg
All rights reserved

Manufacturer:
burster präzisionsmesstechnik gmbh & co kg
Talstraße 1 - 5 P.O.Box 1432
DE-76593 Gernsbach DE-76587 Gernsbach
Germany Germany

Valid from: 28.04.2014

Tel.: (+49) 07224 / 6450
Fax.: (+49) 07224 / 64588
E-Mail: info@burster.com
www.burster.com

Exclusion of warranty liability for operating manuals

All information in the present documentation was prepared and compiled with great care and reproduced subject to effective control measures. No warranty is provided for freedom from errors. We reserve the right to make technical changes. The present information as well as the corresponding technical data can change without notice. Reproduction of any part of this documentation or its processing or revision using electronic systems is prohibited without the manufacturer's prior written approval.

Components, devices and measured value sensors made by burster praezisionsmesstechnik (hereinafter referred to as "product") are the results of targeted development and meticulous research. As of the date of delivery, burster provides a warranty for the proper condition and functioning of these products covering material and production defects for the period specified in the warranty document accompanying the product. However, burster excludes guarantee or warranty obligations as well as any liability beyond that for consequential damages caused by improper use of the product, in particular the implied warranty of success in the market as well as the suitability of the product for a particular purpose. Furthermore, burster assumes no liability for direct, indirect or incidental damages as well as consequential or other damages arising from the provision and use of the present documentation.

Präzisionsmessgeräte, Sensoren und Messsysteme
für elektrische, thermische und mechanische Größen



EG-Konformitätserklärung

EC- Declaration of Conformity according to EN ISO/IEC 17050-1:2010

Name des Herstellers: burster präzisionsmesstechnik gmbh & co kg
Manufacturer's Name:

Adresse des Herstellers: Talstr. 1-5
Manufacturer's Address: 76593 Gernsbach, Germany

erklärt unter alleiniger Verantwortung, dass das gelieferte Produkt
declares under sole responsibility that the product as originally delivered

Produktname: Universal-Kalibrator DIGISTANT® für den Feldeinsatz
Product Name: Universal portable calibrator, developed for use in the field

Modellnummer(n) (Typ): 4420-V001
Models Number / Type:

Produktionsoptionen: Diese Erklärung beinhaltet obengenannte Produkte mit allen Optionen
Options This declaration covers all options of the above product(s)

mit den folgenden europäischen Richtlinien übereinstimmt und entsprechend das CE-Zeichen trägt:
complies with the requirements of the following applicable European Directives, and carries the CE marking accordingly:

2006/95/EC <i>Low Voltage</i>	Elektrische Betriebsmittel zur Verwendung innerhalb bestimmter Spannungsgrenzen <i>Electrical Equipment designed for use within certain voltage limits</i>
2004/108/EC <i>EMC</i>	Elektromagnetische Verträglichkeit <i>Electromagnetic Compatibility</i>

Obengenannte Produkte entsprechen folgenden harmonisierten Normen:
Above named products conform with the following product standards:

Sicherheit: <i>Safety requirements:</i>	IEC 61010-1:2001 / EN 61010-1:2001	Schutzklasse III*
	Messkategorie 1 / CAT 1	Safety class 3
	* Stecker-Netzteil 4495-V001 <i>Power Pack</i>	Schutzklasse 2 <i>Safety class 2</i>

EMV Störaussendung: IEC/CISPR 11:2003 + A1:2004 + A2:2006 / EN 55011:2010
EMC Generic emission:

EMV Störfestigkeit: IEC 61326-1:2005 / EN 61326-1:2006
EMC Generic immunity: Industrie Bereich
Industrial environment

Ergänzende Informationen: / Additional Information:

Das Produkt wurde in einer typischen Konfiguration getestet. Um optimale Störfestigkeit zu erreichen ist das Gerät über geschirmte Leitungen anzuschließen.
The product was tested in a typical configuration. In order to reach optimal electromagnetic immunity the device has to be conducted with shielded line.

Diese Konformitätserklärung betrifft alle nach Ausstellungsdatum ausgelieferten Produkte:
This DoC applies to above-listed products placed on the EU market after:

Gernsbach 06.12.2010 i.V. Christian Karius
Datum / date Quality Manager

Dieses Dokument ist entsprechend EN ISO/IEC 17050-1:2010 Abs. 6.1g ohne Unterschrift gültig / According EN ISO/IEC 17050 this document is valid without a signature.

burster präzisionsmesstechnik gmbh & co kg · Talstr. 1-5 · D-76593 Gernsbach (Postfach 1432 D-76587 Gernsbach) Tel. 07224/645-0 · Fax 645-88
www.burster.de · www.burster.com · info@burster.de

Sitz der Gesellschaft: HRA 530170 Mannheim · Komplementär: burster präzisionsmesstechnik Verwaltungs-GmbH · Sitz der Gesellschaft: Gernsbach · HRB 530130 Mannheim
Geschäftsführer: Matthias Burster · Prokurist: Edgar Migler · UST-Identnr.: DE 144 005 098 · Steuernr.: 39454/10503
Dresdner Bank AG Rastatt Kto. 06 307 073 00 BLZ 662 800 53 · Volksbank Baden-Baden/Rastatt eG Kto. 302 082 00 · BLZ 662 900 00



Table of contents

DIGISTANT® Model 4420-V001

General information	Chapter	1
Preparation for use	Chapter	2
Control elements	Chapter	3
Manual operation	Chapter	4
Remote operation	Chapter	5
Maintenance and customer service	Chapter	6
Technical data	Chapter	7

	Page
1. General Information	11
Application	11
Description	11
2. Preparation for use	13
2.1 Unpacking the device	13
2.2 Supply voltage	13
How to correctly charge/discharge the Ni-MH-accumulator	14
2.3 Connections.....	15
2.4. Operational test.....	16
2.5 Selecting the menu language	16
2.6 Calibration	16
2.7 Storage	16
3. Control elements and terminals	17
3.1 Front panel	17
3.1.1 Display	17
3.1.2 Description of each key	18
3.1.2.1 Description of the keys for the pressure function	18
3.1.3 Measurement mode.....	18
4. Manual operation of the device	21
4.1 Measurement times.....	21
4.2 Measurement function	21
4.2.1 Voltage measurement.....	21
4.2.2 Current measurement.....	22
4.2.3 Temperature measurement	22
4.2.3.1 RJ-INT: Measurement of a thermocouple.....	23
4.2.3.2 RJ-Man: Measurement after the reference junction ...	24
4.2.3.3 RJ-Ext Pt100: Measurement after the reference junction; reference-junction temperature using a Pt100 or precision measurement using the Model 4485 external reference junction	25
4.2.3.4 4-20mA: Measurement after the thermocouple and a linearresponse voltage transducer. Rated output-current range: 4-20 mA	27
4.2.3.5 0-20mA: Measurement after the thermocouple and a linearresponse voltage transducer. Rated output-current range: 0-20 mA	28
4.2.4 Temperature measurement with a Pt100/200/500/1000 and Ni100	30
4.2.4.1 Resistance measurement.....	31

	Page
4.3 Transmission function.....	33
4.3.1 Voltage transmission.....	33
4.3.2 Current transmission.....	33
4.3.3 Simulating a thermocouple	34
4.3.3.1 TC: Simulating a thermocouple	35
4.3.3.2 TC+RJ-Man: Simulating a thermocouple and an external reference junction	36
4.3.3.3 TC+RJ-Aut: Simulating a thermocouple and a reference junction to calibrate a device which records the temperature of the reference junction with a measurement sensor, or simulating with a Model 4485 external reference junction	38
4.3.3.4 TC+4-20mA: Simulating a thermocouple with a linearresponse voltage transducer Rated output-current range: 4-20mA.....	40
4.3.3.5 TC+0-20mA: Simulating a thermocouple with a linearresponse voltage transducer. Rated output-current range: 0-20mA.....	42
4.3.4 Temperature simulation with a Pt100/200/500/1000 and Ni100 ..	44
4.3.4.1 Settings for resistance-thermometer simulation	45
4.3.4.2 Resistance simulationn.....	46
4.4. Power-on/power-off	48
4.5 Changeover between measurement and transmission	48
4.6 Transmission mode	49
4.7 Selecting a function	51
4.8 dX setting.....	53
4.8.1 Storing a value-pair.....	54
4.8.2 Retrieving a value-pair.....	54
4.9 Ramp function	55
4.9.1 Use of the ramp function.....	56
4.10 Setting simultaneous transmission and measurement.....	59
4.10.1 Simultaneous transmission and measurement.....	59

	Page
4.11 Setting the data logger	60
4.11.1 Setting the storage time.....	60
4.11.2 Data logger mode	60
4.11.3 Erasing the data logger's memory	61
Erasing the memory completely	61
Erasing the memory in blocks.....	61
4.11.4 Data logger evaluation.....	62
4.11.5 Statistical evaluation	63
4.11.6 Display of the recorded values	63
4.12 Setting the RS232 interface.....	64
4.13 Min./max. function	65
4.14 Display of the version and calibration stage.....	66
4.15 Setting the background illumination.....	66
4.16 RTD settings.....	67
4.17 Setting the TC model and RJ	68
4.17.1 Setting the reference junction (RJ) for TC transmission	68
4.17.2 Setting the reference junction (RJ) for TC measurement	69
4.17.3 Entering the reference-junction temperature	69
4.17.4 Entering temperatures with RJ = 4-20 mA.....	70
4.17.5 Entering temperatures with RJ = 0-20 mA.....	70
4.17.6 Selecting units for TC and RTD	71
4.18. Range selection and zero offset with U transmission.....	72
4.19 Range selection with RTD transmission.....	73
4.20 Storage and retrieval of device settings	74
4.21 LCD contrast settings	75
4.22 Range selection with I transmission	76
4.23 Setting the ground connection.....	77
4.24 Displaying the data and time	77
4.25 Setting the date and time.....	78

5. Remote operation of the device.....	79
5.1. Control via the serial interface.....	79
Introduction.....	79
Settings in the serial interface menu	79
Explanation of the communications protocol for establishing links.....	80
DIGISTANT® as a master	81
DIGISTANT® as a slave.....	81
Link termination	83
Explanation of the data transmission protocol in accordance with ANSI X3.28 Subcat A3/A4	83
Timer function in accordance with ANSI X 3.28	84
Flow chart of link establishment in accordance with ANSI X3.28 Sub 2.5, A3/A4	85
5.2. SCPI instruction list for the model 4420-V001 DIGISTANT®	86
5.2.1 SCPI Version	86
5.2.2 Measurement Instructions	86
5.2.3 CALCulate Subsystem.....	89
5.2.4 CALibration Subsystem	90
5.2.5 DATalogger Subsystem	97
5.2.6 DISPlay Subsystem.....	101
5.2.7 INPut Subsystem	101
5.2.8 INSTRument Subsystem.....	102
5.2.9 RAMP Subsystem.....	103
5.2.10 SENSE subsystem.....	103
5.2.11 SOURce Subsystem.....	107
5.2.12 STATus Subsystem.....	124
5.2.13 SYSTem Subsystem	125
5.2.14 TRIGger Subsystem ABORT, INITiate	128
5.2.15 UNIT Subsystem.....	128
5.2.16 IEEE488.2 Befehle	129
5.2.17 Status Register	133
5.2.18 CSTat System	134
5.2.19 ROUTe Subsystem	137
5.2.20 DIAGnostic Subsystem.....	140
5.2.21 Enquiry of measured values via interface DIGISTANT® 4420 ...	140
5.3 Sample application	141

6.	Maintenance and customer service	143
6.1	Maintenance	143
6.2	Customer service.....	143
6.3	Manufacturer's guarantee.....	143
6.4	Cleaning	144
6.5	Handling batteries.....	144
7.	Technical data.....	145
7.1	Measure and source.....	145
7.2	Interference-suppression class.....	146
7.3	Long-term stability	146
7.4	Influencing variables.....	146
7.5	Interface (RS232)	146
7.6	Housing	146

1. General Information

1.1 Applications

The DIGISTANT® model 4420-V001 universal calibrator is ideal for testing and calibrating temperature measurement and control devices as well as documenting the measurement results. Due to its versatile functions, this portable device can not only be used on-site but also as a stationary unit in the test shop or laboratory.

The device can measure and simulate voltage, current, temperature and resistance. The pressure modules of the 7131 series can measure and display pressures of up to 200 bar in the correct order of magnitude.

Simultaneous transmission and measurement allow, for example, controllers to be tested precisely. The automatic ramp function allows processes to be controlled.

The universal calibrator measures and simulates 14 types of thermocouple, Ni 100, Pt 100, Pt 200, Pt 500 and Pt 1000. It can also measure resistances of 10 m Ω to 2 k Ω and simulate resistances of 10 Ω to 2 k Ω .

The reference-junction temperature can be entered manually from the keyboard; if required, however, automatic reference to an internal or external junction is also possible.

10 freely programmable memories can be used in each case for storing the basic values and corresponding Δ -values of voltages, currents, thermocouples and resistance sensors. Operate the Δ + or Δ - key to add or subtract the corresponding values.

1.2 Description

The microprocessor-controlled universal calibrator is operated by means of a clearly arranged membrane keyboard. The value-entry keys are coloured differently to the function and memory keys, thus allowing a clear distinction between measurement and transmission variables.

The measurement and transmission values are displayed on a high-contrast alphanumeric supertwist-LCD in two rows of 20 characters each. Transmission values are displayed with the corresponding units.

In the "Simulate Thermocouple" mode, the thermocouple data is displayed together with the standard abbreviation and the type of reference junction. On switch-off, the values entered last are stored.

In the "Measure Thermocouple" mode, the selected thermocouple, type of reference-junction compensation and measurement value are displayed. An internal reference junction allowing the compensation of even large fluctuations in ambient temperature has been integrated specially for the measurement and simulation of thermocouples.

The integrated Ni-MH accumulator is protected against overload and deep discharge. The accompanying plug-in power supply allows the device to be charged even during floating operation.



2. Preparation for use

2.1 Unpacking the device

The device weighs 2.5 kg and is enclosed in appropriate shock-proof packaging.

Unpack the device carefully and check whether the scope of delivery is complete.

The standard scope of delivery includes:

- 1 universal calibrator DIGISTANT® model 4420-V001
- 1 plug-in power supply model 4495-V001
- 1 3 pin, 3.5 mm jack connector

Carefully check the device for any signs of damage. If any damage seems to have occurred during transportation, inform the supplier within 72 hours.

Store the packaging so that it can be examined by a representative of the manufacturer and/or supplier.

The DIGISTANT® must only be transported in its original or an equivalent packaging.

2.2 Supply voltage

The required voltage is supplied by the integrated accumulator or the accompanying power supply unit. (to be connected to the "Charge" socket).

Only use the 4495-V001 power supply unit included in the scope of delivery!

The DIGISTANT® provides fully normal operation even during re-charging. Continuous operation on the mains power supply does not harm the Ni-MH batteries.

Even if the batteries are completely discharged, the DIGISTANT® can be operated from the power supply unit. The batteries are gradually charged in this process.

Charging is indicated by an illuminated LED labelled 'Charge' on the front panel. The maximum charging period is 11 hours.

Once the battery is fully charged, a monitoring function terminates the charging process. The 'Charge' LED goes off and floating operation is commenced. Self-discharge is thus compensated.

Each time the external power supply is connected, a new charging procedure lasting at least 40 minutes is commenced. If the battery is already fully charged, it becomes slightly overcharged. This is not harmful, but should be avoided if possible.

If the internal temperature of the device is $< 5\text{ °C}$ or $> 40\text{ °C}$, charging is not possible. In this case, the device needs to be restarted.

The battery is charged with brief current pulses. This prolongs its service life and reduces the memory effect (also refer to Page 16 "Notes on correct charging and discharge of the integrated Ni-MH battery").

Operational period per accumulator charge: 7-10 hours (depending in the power load).

Supply voltage for the
type 4495-V001 plug-in power supply: 230 V AC + 6 %, - 10 %, 50 - 60 Hz.

How to correctly charge/discharge the Ni-MH accumulator

- It is advisable to discharge the accumulator completely at regular intervals (from twice a week to once a month, depending on the degree of use) and then recharge it. This has a relaxing effect on the accumulator, making it more reliable and durable.

- Long storage periods result in different charging levels in a multi-cell block, due to the different rates of self-discharge.
In the worst case, this could lead to a pole reversal of the weakest cell during discharge.

If it is at all possible for the charging unit to reverse the polarity of this cell again, it will be further damaged.
Its rate of self-discharge will increase as a result.

Remedy: After long periods of storage (or power supply operation without discharging) discharge the accumulator by just 25% and then recharge it completely.
 After that, discharge the accumulator completely and recharge it again.

- High temperatures during storage and operation should be avoided as far as possible.
Temperatures of around 20 °C are favorable.
Avoid temperatures of less than 10 °C during charging.
This will increase the service life of the accumulator and reduce the rate of self-discharge.

- Frequent recharging after partial discharging leads to a memory effect.
In this process, an internal change occurs in the accumulator, causing the available capacitance to adapt itself to the regular discharge quantity. This effect can be reversed through several complete discharging/charging cycles.

- Loss of capacitance is a normal phenomenon occurring in all accumulators. A loss of roughly 40% after several years of use is normal. Operation at around 20° C and regular discharging/charging minimize such losses.

2.3 Connections

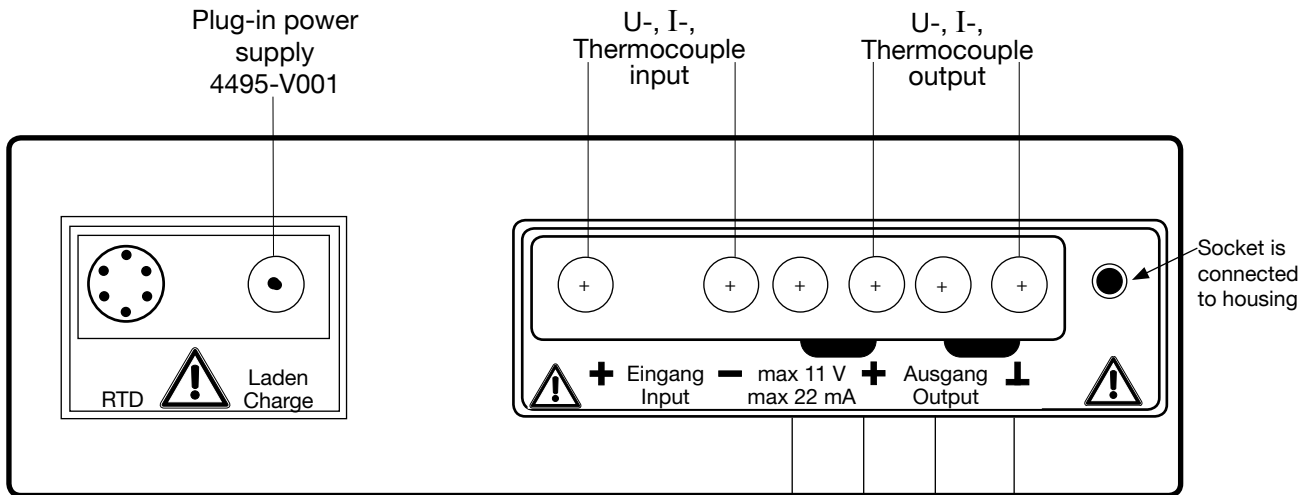

Resistance- Pt100; Ni100-, Pt200; Pt500-, Pt1000 **measurement**

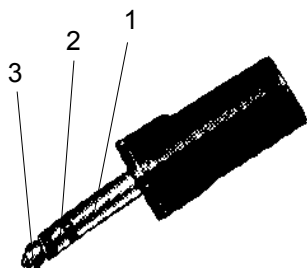
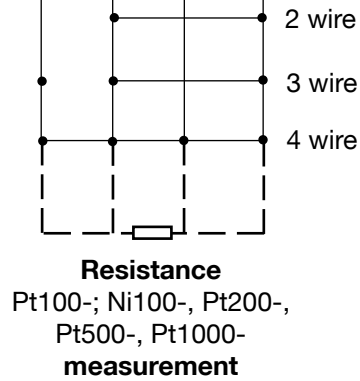
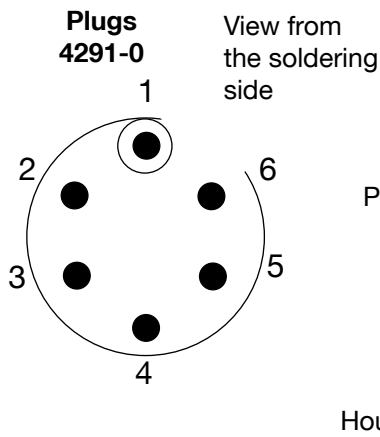

Model 4420-V001	PC
3.5 mm, 3-pin connector	9 pin, submin D
GND 1	5 GND
RXD 2	3 TXD
TXD 3	2 RXD
	4 DTR
	6 DSR
	8 CTS

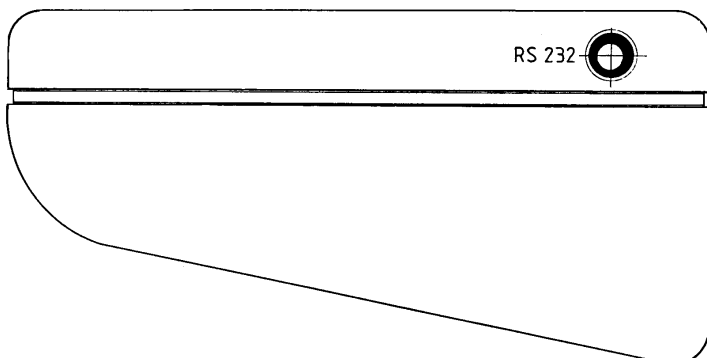

2.4 Operational test

After the device is switched on, the following text appears on the display for approx. 5 seconds:

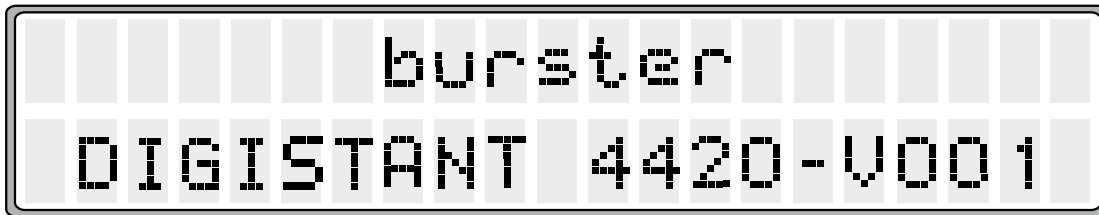

This is automatically followed by a display of the value set last.

2.5 Selecting the menu language

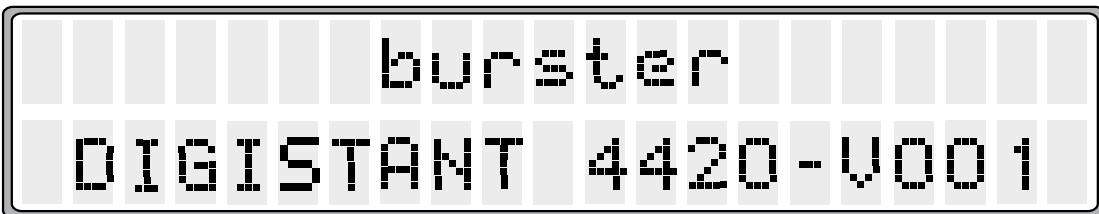

Different languages can be selected in this menu. After the device is switched on, the following identification message appears for approx. 5 s:



Pressing the  key during this display calls up the language selection menu:



The currently selected language is shown in the 2nd line of the LCD.

Use the  and  keys to select GERMAN, FRENCH or ENGLISH as the menu language.

Press ENTER to return to the initial state. The currently displayed language is now standard.

2.6 Calibration

The device was calibrated before delivery. The measurement devices used for this comply with the German standards specified by DIN ISO 9000ff .

The device should be recalibrated after approximately one year.

Calibration is carried out via one of the interfaces and must only be performed by the manufacturer.

2.7 Storage

Storage is permitted at temperatures between - 10 °C and 60 °C. If the device has been exposed to moisture, ensure that it is dried before switching it on. Other start-up measures following storage are not necessary.

3. Control elements and terminals



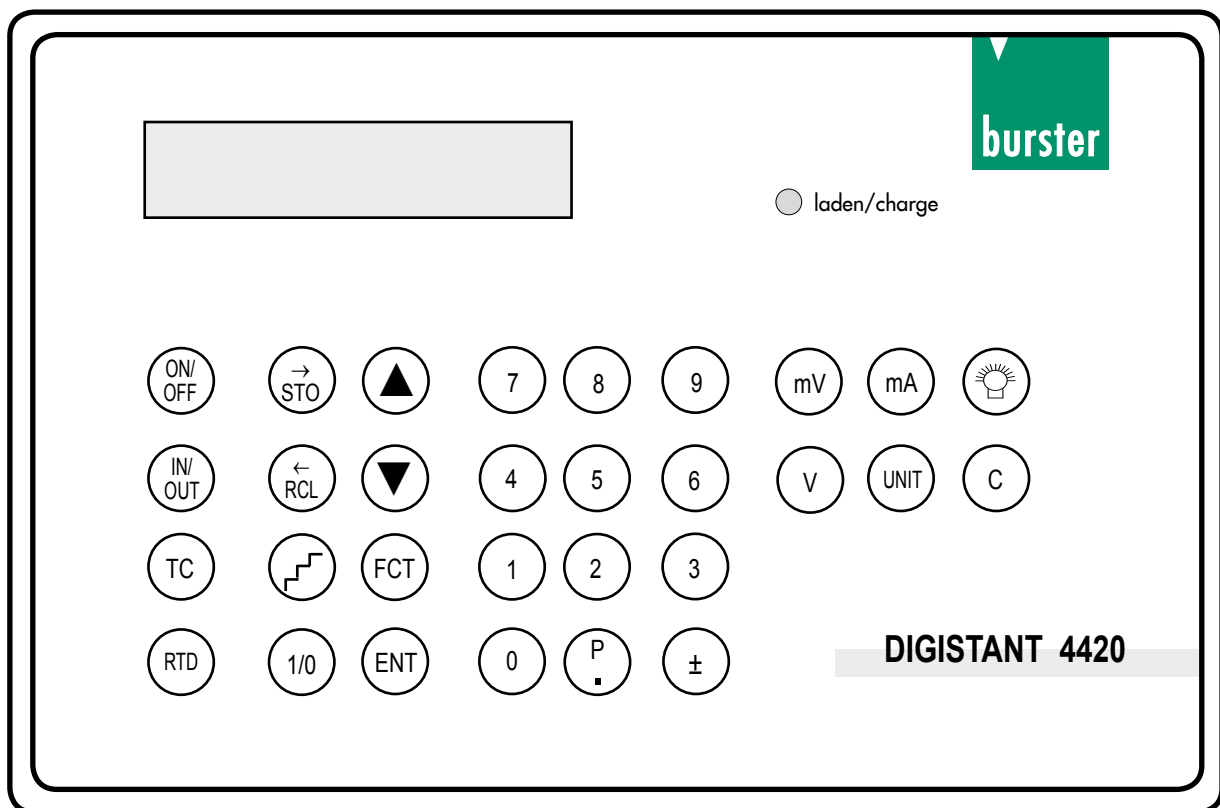







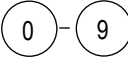





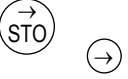
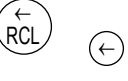

3.1 Front panel













3.1.1 Display

The device has an LCD display with two rows of 20 characters each.

3.1.2 Description of each key

	Number keys	For entering numerals.
	Point key	IN: Selection of pressure measurement OUT: For entering the decimal point
	Sign key	For entering the sign.
	Cancel key	For cancelling a current entry.
	Milliampere key	- For acknowledging an entered current value. - In the measuring mode, this effects a switch over to current measurement.
	Millivolt key	
	Volt key	- For acknowledging an entered voltage value. - In the measuring mode, this effects a switch over to voltage measurement.
	Store key or cursor right key	- For storing the currently entered value and the currently set delta-X value in the transmission mode. - In the measurement mode, this activates/deactivates the data logger. - As the cursor right key, it is meant for scrolling through the various parameters in the function menus.
	Recall key or cursor left key	- For retrieving a stored value-pair (transmission and delta-X values) in the transmission mode. - As the cursor left key, it is meant for scrolling through the various parameters in the function menus.
	Cursor up key	- If the delta-X function is being used, the set delta-X value is added to or subtracted from the value just entered. - If the ramp function is being used, the set ramp can be processed step-by-step in both directions. - If the menu function is being used, this key allows cursor control.
	Cursor down key	
	Function key	For menu selection of the special functions.
	ENTER key	- For indirect menu selection of a special function. - For exiting the menus of the special functions. - Serves as the LOCAL key during operation via an external interface.
	Ramp key	Toggle function: For activating/deactivating the ramp function.
	Start/Stop key	Toggle function: For starting/stopping the ramp function .
	ON/OFF key	For switching the device on/off.
	Lamp key	For switching the LED background illumination on/off.
	TC key	For selecting thermocouple transmission/measurement.
	RTD key	For selecting RTD transmission/measurement.
	IN/OUT key	For switching over between transmission and measurement.
	Units key	In the transmission mode, this key acknowledges the entry of a value for TC or RTD transmission. In the measurement mode, TC or RTD measurement is selected.

3.1.2.1 Description of the keys for the pressure function

-  Meas. mode: Selects pressure measurement
-  +  P meas. mode: Selects the battery-test function
-  +  P meas. mode: Selects balancing during pressure measurement
-  +  Selects the required pressure module
-  +  or Selects pressure measurement with U or I simulation
or Selects pressure measurement with U or I measurement
-  +  Changes units during measurements with the pressure modules









3.1.3 Measurement mode

Prerequisite: The device must be in the measurement mode; if not, operate the  key.
The LCD might provide the following display, for example:

			I	N				1	0	.	2	3	5			m	A		

Measurements are carried out whenever the device is in the measurement mode. They are not started explicitly. Measured values are displayed in the first row of the LCD. The following entries are possible in the measurement mode:

Keys

-  Switches the device to voltage measurement.
-  Switches the device to current measurement.
-  Switches the device to thermocouple measurement.
-  Switches the device to Ni100, Pt100, Pt200, Pt500 or Pt1000 measurement, depending on the setting in the function menu.
-  Switches the device to RTD or TC measurement, depending on the option selected last.
-  Switches the device to transmission mode.
-  Selects a function.
-  Switches the device to data logger mode.
-  If the min./max. function has been selected, the minimum and maximum values are reset to the current measured value.

4. Manual operation of the device

The device can be operated from the keyboard or via the RS232 interface.
Keyboard operation is described in the following.

4.1 Measurement times for DIGISTANT® 4420

Generally: Basic measurement rate is two measurements/sec
One zero-point measurement (taking 0.5 s) for every 250 measurements

For U, I, TC (RJMAN), TC (4-20 mA), TC (0-20 mA) measurement

Two measurements /sec, plus one zero-point measurement (taking 0.5 s) for every 250 measurements.
($249 \cdot 0.5 \text{ s} + 1 \cdot 1 \text{ s}$)

For RTD measurement

Two measurements/sec, plus one Uref measurement (taking 1 s) and one zero-point measurement (taking 0.5 s) for every 250 measurements. ($249 \cdot 0.5 \text{ s} + 1 \cdot 1.5 \text{ s}$)

For TC (RJINT), TC (RJEXT)

Two measurements/sec plus one Uref measurement (taking 1 s), one Pt100 measurement (taking 1 s) and zero-point measurement (taking 0.5 s) for every 83 measurements. ($82 \cdot 0.5 \text{ s} + 1 \cdot 3 \text{ s}$)

4.2 Measurement function

Voltage Current Thermocouple

(TYP: R,S,B,J,T,E,K,U,L,N,C,D,G2,M) M -> NiMo(18%) - Ni manufactured by Ipsen.

RTD

(MODEL: Ni100 or Pt100)

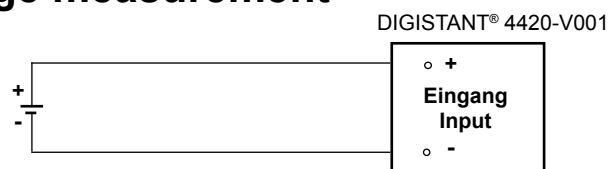

4.2.1 Voltage measurement

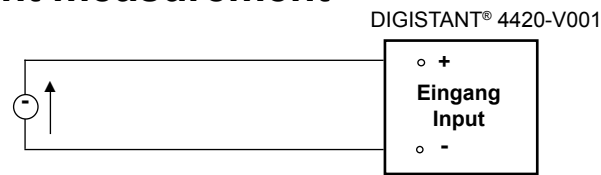

- Switch on the device and connect it as shown above.
- Switch the device with IN/OUT to "Measurement function" and
- with mV or V to voltage measurement.

4.2.2 Current measurement



- Switch on the device and connect it as shown above..
- Switch the device with  to "Measurement function" and
- with  to current measurement.

4.2.3 Temperature measurement

The DIGISTANT® Model 4420-V001 allows measurement with the following types of thermocouples:

No.	Thermocouple model		Standard	Temperature range [°C]
0	TC Type R	PtRh13-Pt	EN 60584-1 / ITS 90	- 50.0 ... + 1766.9
1	TC Type S	PtRh10-Pt	EN 60584-1 / ITS 90	- 50.0 ... + 1766.9
2	TC Type B	PtRh30-Pt-PtRh6	EN 60584-1 / ITS 90	+ 99.5 ... + 1820.0
3	TC Type J	Fe-CuNi	EN 60584-1 / ITS 90	- 209.9 ... + 1200.0
4	TC Type T	Cu-CuNi	EN 60584-1 / ITS 90	- 269.9 ... + 399.9
5	TC Type E	NiCr-CuNi	EN 60584-1 / ITS 90	- 269.9 ... + 999.9
6	TC Type K	Ni Cr-NiAl	EN 60584-1 / ITS 90	- 269.9 ... + 1371.9
7	TC Type U	Cu-CuNi	DIN 43710 / IPTS 68	- 199.9 ... + 599.9
8	TC Type L	Fe-CuNi	DIN 43710 / IPTS 68	- 199.9 ... + 899.9
9	TC Type N	NiCrSi-NiSi	EN 60584-1 / ITS 90	- 269.9 ... + 1299.9
10	TC Type M	NiMo18-Ni	General Electr. IPTS 68	0 ... 1400.0
11	TC Type C	W5Re-W26Re	Hoskins ITS 90	0 ... 2314.9
12	TC Type D	W3Re-W25Re	Hoskins ITS 90	0 ... 2315.0
13	TC Type G2	W-W26Re	Hoskins ITS 90	0 ... 2315.0

Five models of measurement are possible, depending on the type of reference junction (abbreviated "RJ"):

1. Direct measurement of a thermocouple. The reference junction is formed electronically in the DIGISTANT®. The thermocouple can be connected with thermoelectric wires or compensation leads.
2. Measurement after the reference junction. The temperature of the reference junction is constant and known. The unit is connected with copper leads.
3. Measurement after the reference junction. The temperature of the reference junction is constant and known. It is therefore measured with a Pt100.
4. The thermoelectric voltage is converted into current by a linear-response transducer. Rated current range: 4 - 20 mA. Connections are looped into the electric circuit.
5. As in 4. but with a rated current range of 0 - 20 mA.

4.2.3.1 RJ-INT: Measurement of a thermocouples

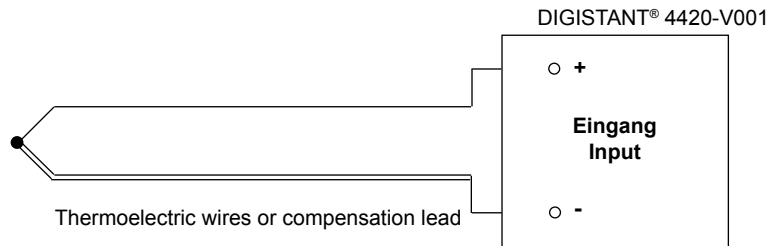

The reference junction is located inside the device (internal). It is simulated electronically by a built-in Pt100 sensor.

- Switch on the device and connect it as shown above.

Selection of the thermocouple

- Press the **FCT** and **TC** keys. The "TC selection" display appears.
- Using the **→** or **←** key, select the desired thermocouple.

Selection of the reference junction

- After that, press the **▲** or **▼** key and select "Measure:.....".
- Then use the **→** or **←** key to select "Measure: RJ-INT".
- Acknowledge with **ENT**.

Selection of the unit

- After pressing the **FCT** and **UNIT** keys, set the correction cursor using the **▲** or **▼** key to TC.
Using the **→** or **←** key, select °C, °F or K.
- Acknowledge with **ENT**.

Selection of the "RJ:INT" measurement function

- If the device is in the "OUT" transmission mode, first switch it to the "IN" measurement mode by pressing the **IN/OUT** key.
- By pressing **TC** you can then invoke the set measurement mode "RJ:INT".

4.2.3.2 RJ-Man: Measurement after the reference junction; the reference-junction temperature is constant and known

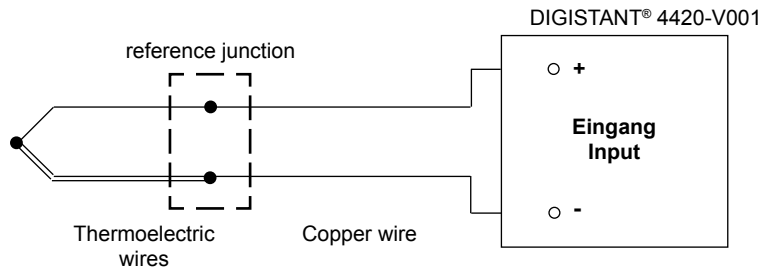

- Switch on the device and connect it as shown above.

Selection of the thermocouple

- Press the **FCT** and **TC** keys. The "TC selection" display appears.
- Using the **→** or **←** key, select the desired thermocouple.

Selection of the reference junction

- After that, press the **▲** or **▼** key and select "Measure:.....".
- Then use the **→** or **←** key to select "Measure:RJ-MAN".
- Acknowledge with **ENT**.

The following display appears:

>	S	E	T	T	I	N	G				R	J	-	M	A	N	
	R	J	:														

- You can now select the displayed temperature value with **ENT**, or enter the new reference junction temperature, press the **UNIT** key and acknowledge the new value with **ENT**.

Selection of the unit

- After pressing the **FCT** and **UNIT** keys, set the correction cursor using the **▲** or **▼** key to TC.
Using the **→** or **←** key, select °C, °F or K.
- Acknowledge with **ENT**.

Selection of the "RJ:MAN" measurement function

- If the device is in the "OUT" transmission mode, first switch it to the "IN" measurement mode by pressing the **IN/OUT** key.
- By pressing **TC** you can then invoke the set measurement mode "RJ:MAN".

4.2.3.3 RJ-Ext Pt100: measurement after the reference junction; reference-junction temperature using a Pt100 or precision measurement using the Model 4485 external reference junction.

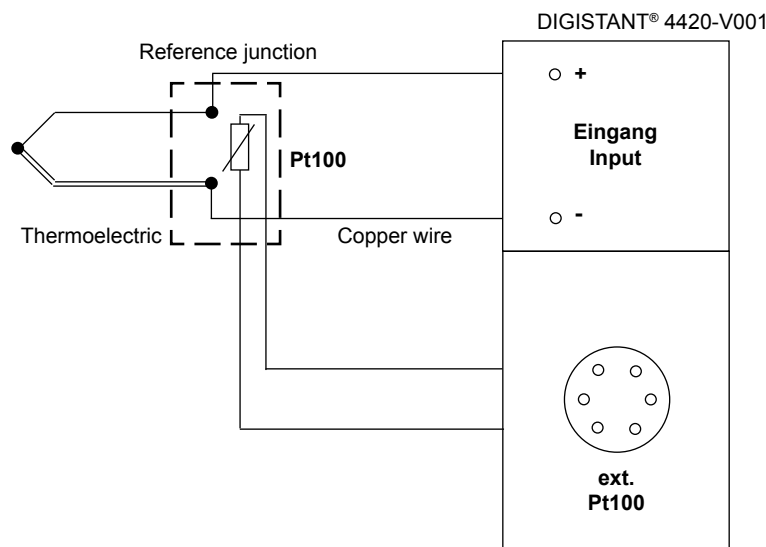

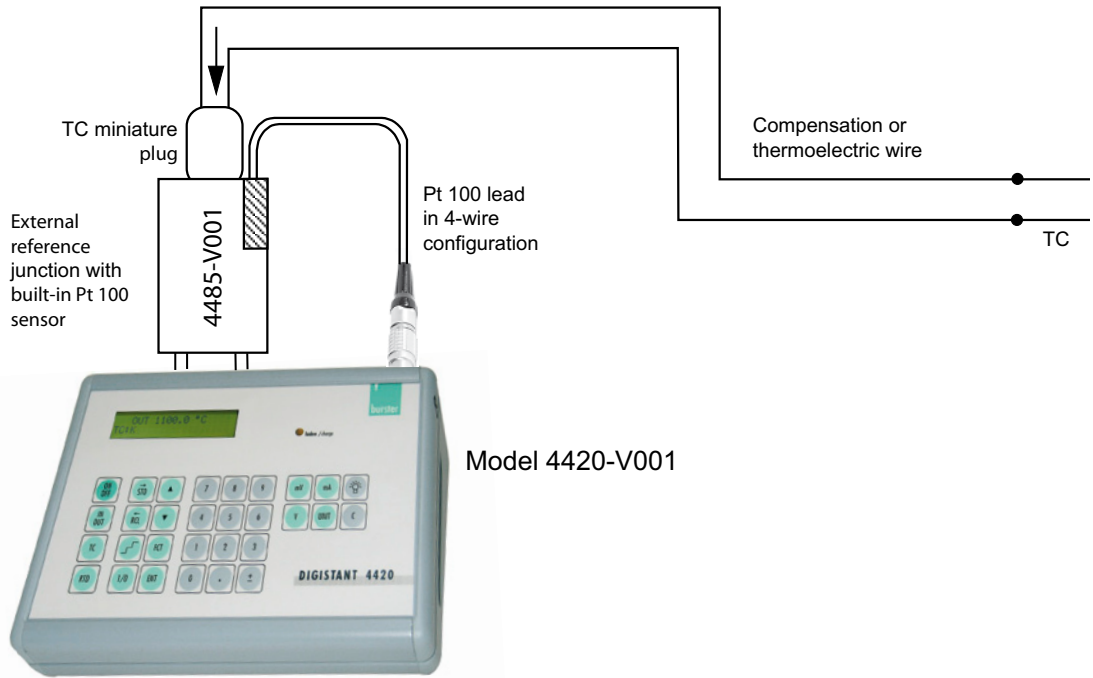

- Switch on the device and connect it as shown above.

Selection of the thermocouple

- Press the **FCT** and **TC** keys. The "TC selection" display appears.
- Using the **→** or **←** key, select the desired thermocouple.

Selection of the reference junction

- After that, press the **▲** or **▼** key and select "Measure:.....".
- Then use the **→** or **←** key to select "Measure:RJ-EXT".
- Acknowledge with **ENT**.

Selection of the unit

- After pressing the **FCT** and **UNIT** keys, set the correction cursor using the **▲** or **▼** key to TC.
Using the **→** or **←** key, select °C, °F or K.
- Acknowledge with **ENT**.

Selection of the "RJ:EXT" measurement function

- If the device is in the "OUT" transmission mode, first switch it to the "IN" measurement mode by pressing the **IN/OUT** key.
- By pressing **TC** you can then invoke the set measurement mode "RJ:EXT".

4.2.3.4 4-20mA: Measurement after the thermocouple and a linearresponse voltage transducer. Rated output-current range: 4-20mA

In this mode, a thermocouple with a reference junction based on 0 °C is exposed to the temperature to be registered at the measurement point.

The thermocouple is connected in series to a U/I transducer which converts the output voltage of the thermocouple linearly into a current and supplies it to the DIGISTANT®.

To be able to calculate the temperature at the measurement point from the measured current, the DIGISTANT® requires

- the temperature corresponding to the lowest current value (4 mA) and
- the temperature corresponding to the highest current value (20 mA).

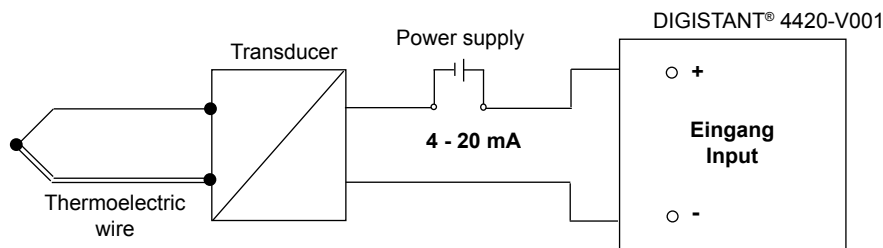

- Switch on the device and connect it as shown above.





Selection of the thermocouple

- Press the **FCT** and **TC** keys. The "TC selection" display appears.
- Using the **→** or **←** key, select the desired thermocouple.







Selection of the reference junction

- After that, press the **▲** or **▼** key and select "Measure:.....".
- Then use the **→** or **←** key to select "Measure:4-20 mA".
- Acknowledge with **ENT**.
- The temperature values last allocated to the current values of 4 mA and 20 mA are then displayed.
- Modify the temperature limits or acknowledge the present entry with **ENT**.



Modification of the temperature limits

- The correction cursor indicates the temperature limit which can be modified. You can move the correction cursor up with  and down with .
- Enter the new temperature values and acknowledge the entry with .
- Complete your modification of the temperature limits with .

Selection of the unit

- After pressing the  and  keys, set the correction cursor using the  or  key to TC. Using the  or  key, select °C, °F or K.
- Acknowledge with .

Selection of the "RJ:4-20mA" measurement function

- If the device is in the "OUT" transmission mode, first switch it to the "IN" measurement mode by pressing the .
- By pressing  you can then invoke the set measurement mode "RJ:4-20mA".

4.2.3.5 0-20mA: Measurement after the thermocouple and a linear response voltage transducer.

Rated output-current range: 0-20mA

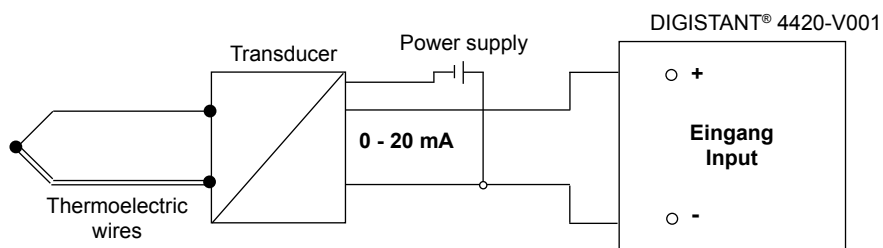

- Switch on the device and connect it as shown above.

Selection of the thermocouple

- Press the **FCT** and **TC** keys. The "TC selection" display appears.
- Using the **→** or **←** key, select the desired thermocouple.

Selection of the reference junction

- After that, press the **▲** or **▼** key and select "Measure:.....".
- Then use the **→** or **←** key to select "Measure:0-20 mA".
- Acknowledge with **ENT**.
- The temperature values last allocated to the current values of 0 mA and 20 mA are then displayed.
- Modify the temperature limits or acknowledge the present entry with **ENT**.

Modification of the temperature limits

- The correction cursor indicates the temperature limit which can be modified. You can move the correction cursor up with **▲** and down with **▼**.
- Enter the new temperature values and acknowledge the entry with **UNIT**.
- Complete your modification of the temperature limits with **ENT**.

Selection of the unit

- After pressing the **FCT** and **UNIT** keys, set the correction cursor using the **▲** or **▼** key to TC. Using the **→** or **←** key, select °C, °F or K.
- Acknowledge with **ENT**.

Selection of the "RJ:0-20mA" measurement function

- If the device is in the "OUT" transmission mode, first switch it to the "IN" measurement mode by pressing the **IN/OUT** key.
- By pressing **TC** you can then invoke the set measurement mode "RJ:0-20mA".

4.2.4 Temperature measurement with a Pt100/200/500/1000 and Ni100

Connect the resistance sensor in 4 wire configuration to a 6-pin Lemo-plug (size 1).

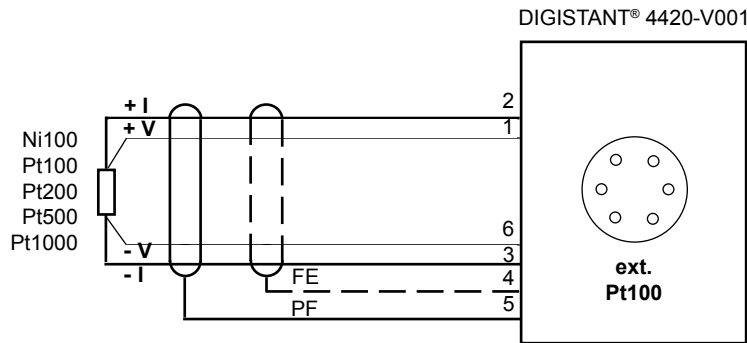

- Switch on the device and connect it as shown above.

RTD setting

- This menu is obtained by selecting the [FCT] and [RTD] functions. The following display appears on the LCD:

			R	T	D	-	S	E	T	T	I	N	G					
			R	T	D	:												

- Various parameters for RTD measurement and transmission are set in this menu.
- The different parameters are selected with the ▲ and ▼ cursor keys.

RTD selection

- The → and ← keys are used to toggle between the following RTD types:

Pt100 (Pt100 is selected)
 Ni100 (Ni100 is selected)
 Pt200 (Pt200 is selected)
 Pt500 (Pt200 is selected)
 Pt1000 (Pt1000 is selected)

RL-OUT setting

- No setting is required for measurement.

RL-IN setting

- Here, you can specify whether or not the lead resistance RL should be considered for RTD measurement.
The \rightarrow and \leftarrow keys can be used to toggle between the following options:

ON RL is subtracted from the RTD measurement value
OFF RL is not considered.

RL- entry

- The lead resistance (for RTD transmission and measurement) can be adjusted over a value range of 1 Ω to 99 Ω with the $\text{\textcircled{0}}$ – $\text{\textcircled{9}}$ number keys.

Selection of the unit

- After pressing the $\text{\textcircled{FCT}}$ and $\text{\textcircled{UNIT}}$ keys, set the correction cursor using the \blacktriangle or \blacktriangledown key to RTD.
Using the \rightarrow or \leftarrow key, select °C, °F or K.
- Acknowledge with $\text{\textcircled{ENT}}$.

Selection of the "RTD:XXXX" measurement function

- If the device is in the "OUT" transmission mode, first switch it to the "IN" measurement mode by pressing the $\text{\textcircled{IN/OUT}}$ key.
- By pressing $\text{\textcircled{RTD}}$ you can then invoke the set measurement mode "RTD:XXXX".

4.2.4.1 Resistance measurement

- After pressing the $\text{\textcircled{FCT}}$ and $\text{\textcircled{UNIT}}$ keys, set the correction cursor using the \blacktriangle or \blacktriangledown key to RTD.
- Using the \rightarrow or \leftarrow key, select the Ω unit.
- Acknowledge with $\text{\textcircled{ENT}}$.

RTD setting

This menu is obtained by selecting the [FCT] and [RTD] functions. The following display appears on the LCD:

			R	T	D	-	S	E	T	T	I	N	G						
	R	T	D	:															

- Various parameters for RTD measurement and transmission are set in this menu.
- The different parameters are selected with the ▲ and ▼ cursor keys.

RTD selection

- If the "Ω" unit has been selected, resistance measurement is possible with every type of RTD.

RL-OUT setting

- No setting is required for measurement.

RL-IN setting

- Here, you can specify whether or not the lead resistance RL should be considered for RTD measurement.
The → and ← keys can be used to toggle between the following options:

ON RL is subtracted from the RTD measurement value
OFF RL is not considered.

RL entry

- The lead resistance (for RTD transmission and measurement) can be adjusted over a value range of 1 Ω to 99 Ω with the 1-9 number keys.
- Press the ENT key to save the newly selected values.

Selection of resistance measurement

- If the device is in the "OUT" transmission mode, first switch it to the "IN" measurement mode by pressing the IN/OUT key.
- By pressing RTD you can then invoke the set measurement mode "RTD:XXXX".

4.3 Transmission function

Voltage Current Thermocouples

(TYP: R,S,B,J,T,E,K,U,L,N,C,D,G2,M) M -> NiMo(18%) - Ni manufactured by Ipsen

RTD

(TYPE: Ni100 oder Pt100)

4.3.1 Voltage transmission

DIGISTANT® 4420-V001

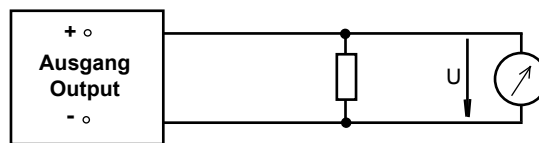

- Switch on the device and connect it as shown above.
- Switch the device using IN/OUT to "Output mode" and enter the setpoint voltage:

Restrictions on the setpoint voltage:

- It must lie in a range of ± 11 V.
- The entry must be mathematically correct.
- It must not be longer than 5 digits.
- Complete your entry with V or mV .

If automatic ranging is inactive, the device indicates "M" (manual ranging) in addition to the setpoint value.

If automatic ranging is active, the device selects the ideal range, indicates the setpoint value with a resolution matching that of the range, and supplies the voltage at the output.

4.3.2 Current transmission

DIGISTANT® 4420-V001

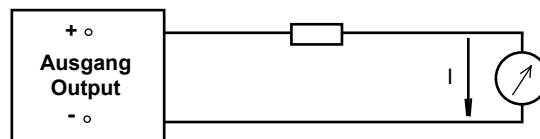

- Switch on the device and connect it as shown above.
- Switch the device using IN/OUT to "Output mode" and enter the setpoint current:

- Restrictions on the setpoint current:
 - It must lie in a range of ± 22 mA.
 - The entry must be mathematically correct.
 - It must not be longer than 5 digits.
 - Complete your entry with mA .

If you simply press the mA key without entering a value, the device supplies 0 mA.

4.3.3 Simulating a thermocouples

The DIGISTANT® Model 4420-V001 allows the following types of thermocouple to be simulated:

No.	Thermocouple model		Standard	Temperature range [°C]
0	TC Type R	PtRh13-Pt	EN 60584-1 / ITS 90	- 50.0 ... + 1766.9
1	TC Type S	PtRh10-Pt	EN 60584-1 / ITS 90	- 50.0 ... + 1766.9
2	TC Type B	PtRh30-Pt-PtRh6	EN 60584-1 / ITS 90	+ 99.5 ... + 1820.0
3	TC Type J	Fe-CuNi	EN 60584-1 / ITS 90	- 209.9 ... + 1200.0
4	TC Type T	Cu-CuNi	EN 60584-1 / ITS 90	- 269.9 ... + 399.9
5	TC Type E	NiCr-CuNi	EN 60584-1 / ITS 90	- 269.9 ... + 999.9
6	TC Type K	Ni Cr-NiAl	EN 60584-1 / ITS 90	- 269.9 ... + 1371.9
7	TC Type U	Cu-CuNi	DIN 43710 / IPTS 68	- 199.9 ... + 599.9
8	TC Type L	Fe-CuNi	DIN 43710 / IPTS 68	- 199.9 ... + 899.9
9	TC Type N	NiCrSi-NiSi	EN 60584-1 / ITS 90	- 269.9 ... + 1299.9
10	TC Type M	NiMo18-Ni	General Electr. IPTS 68	0 ... 1400.0
11	TC Type C	W5Re-W26Re	Hoskins ITS 90	0 ... 2314.9
12	TC Type D	W3Re-W25Re	Hoskins ITS 90	0 ... 2315.0
13	TC Type G2	W-W26Re	Hoskins ITS 90	0 ... 2315.0

Five types of thermocouple simulation are possible (depending on the position of the reference junction RJ):

1. Simulation of a thermocouple without a reference junction.
The DIGISTANT® is connected to the test device by means of thermoelectric wires or compensation leads.
2. Simulation of a thermocouple and a connected reference junction.
The temperature of the reference junction is constant and known. The test device is connected by means of copper leads. The DIGISTANT® must be set to the same reference-junction temperature as the measurement device under test.
3. Simulation of a thermocouple and a connected reference junction.
The temperature of the reference junction is unknown and therefore registered with a Pt100 which is connected to the measurement device under test. The thermocouple and the Pt100 are to be brought into close thermal contact. The measurement device is connected to the DIGISTANT® with copper leads.
4. Simulation of a thermocouple with a connected linear-response voltage transducer. Rated range of the measurement transducer: 4 - 20 mA.
Note that the DIGISTANT® has active outputs. Therefore, disconnect the voltage supply and short-circuit the feed before switching over from measurement to transmission!
5. As in 4. but with a rated current range of 0 - 20 mA.

4.3.3.1 TC: Simulating a thermocouple

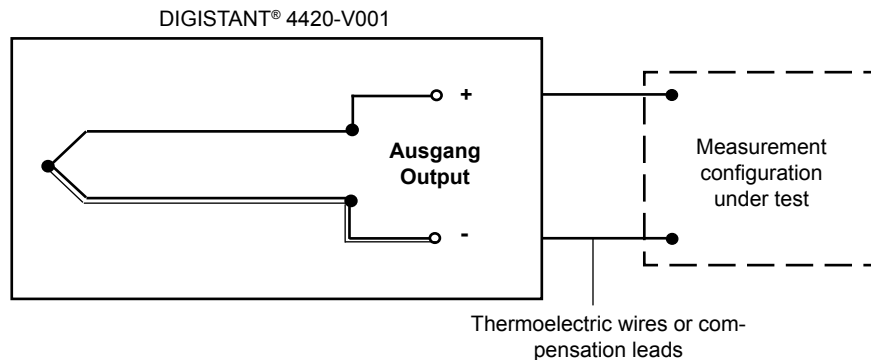

- Switch on the device and connect it as shown above.

Selection of the thermocouple

- Press the **FCT** and **TC** keys. The "TC selection" display appears.
- Using the **→** or **←** key, select the desired thermocouple.

Selection of the reference junction

- After that, press the **▲** or **▼** key and select "Transmit:XXXX".
- Then use the **→** or **←** key to select "Transmit:TC".
- Acknowledge with **ENT**.

Selection of the unit

- After pressing the **FCT** and **UNIT** keys, set the correction cursor using the **▲** or **▼** key to TC.
Using the **→** or **←** key, select °C, °F or K.
- Acknowledge with **ENT**.

Selection of the "TC: Thermocouple simulation" mode

- If the device is in the "IN" measurement mode, first switch it to the "OUT" transmission mode by pressing the **IN/OUT** key.
- By pressing **TC** you can then invoke the set transmission mode "TC: Thermocouple simulation".

4.3.3.2 TC+RJ-Man: Simulating a thermocouple and an external reference junction

The reference-junction temperature set on the measurement device under test must also be entered on the DIGISTANT®.

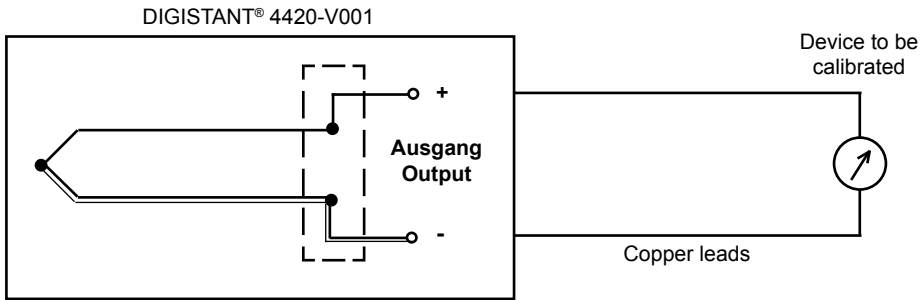

- Switch on the device and connect it as shown above.

Selection of the thermocouple

- Press the **FCT** and **TC** keys. The "TC selection" display appears.
- Using the **→** or **←** key, select the desired thermocouple.

Selection of the reference junction

- After that, press the **▲** or **▼** key and select "Transmit:XXXX".
- Then use the **→** or **←** key to select "Transmit:TC+RJ-MAN".
- Acknowledge with **ENT**.
- The following display appears:

		S	E	T	T	I	N	G			R	J	-	M	A	N			
		R	J	:	X	X	.	X	°	C									

- Now you can select the displayed value with **(ENT)** or enter a new reference junction temperature and complete this entry with the **(UNIT)** key.
- Acknowledge with **(ENT)**.

Selection of the unit

- After pressing the **(FCT)** and **(UNIT)** keys, set the correction cursor using the **(▲)** or **(▼)** key to TC.
Using the **(→)** or **(←)** key, select °C, °F or K.
- Acknowledge with **(ENT)**.

Selection of the "TC:X RJ:MAN" transmission mode

- If the device is in the "IN" measurement mode, first switch it to the "OUT" transmission mode by pressing the **(IN/OUT)** key.
- By pressing **(TC)** you can then invoke the set transmission mode "TC: X RJ:MAN".

4.3.3.3 TC+RJ-Aut: Simulating a thermocouple and a reference junction to calibrate a device which records the temperature of the reference junction with a measurement sensor, or simulating with a Model 4485 external reference junction

The DIGISTANT® 4420-V001 records the temperature of the external sensor or the sensor of the reference junction model 4485 continuously and considers it during output in the automatic mode.

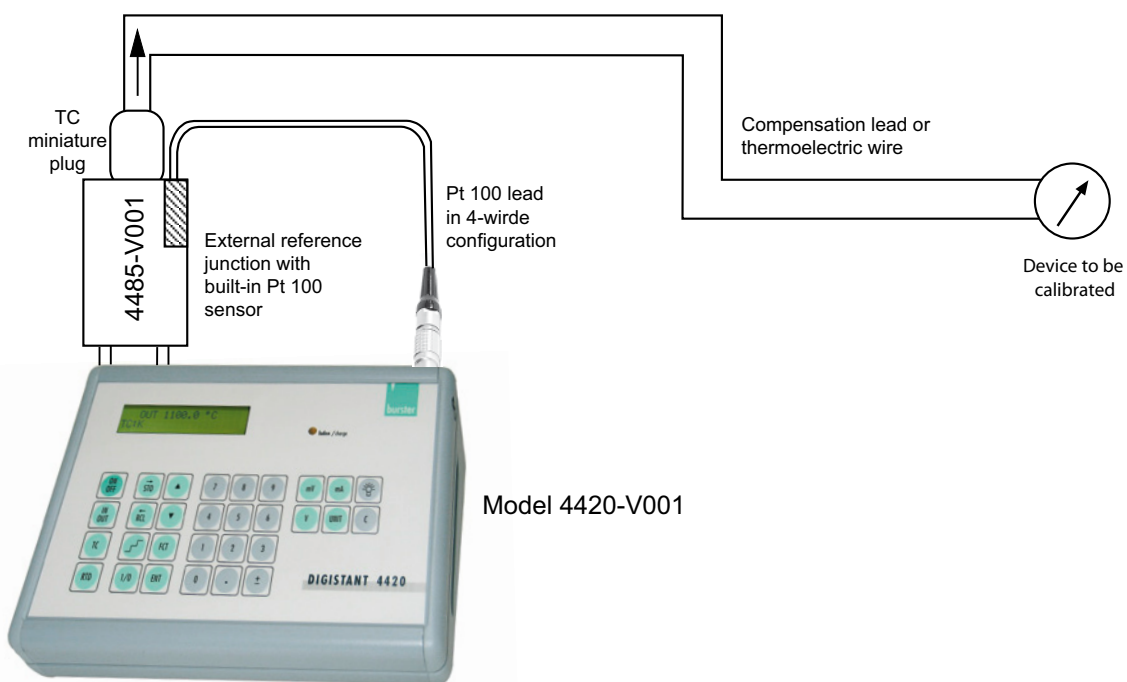
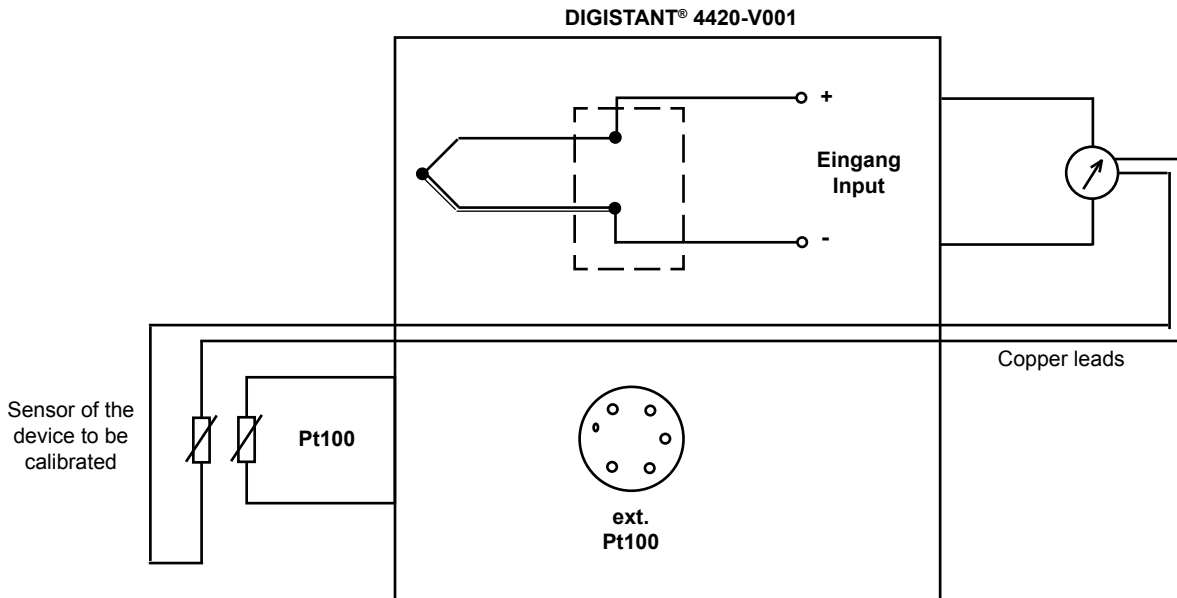

- Switch on the device and connect it as shown on the neighbouring page.
- The Pt100 sensor which you connect to the "Ext. Pt 100" socket must comply to a sufficient degree with the DIN (German Industrial Standard). Bring it into close thermal contact with the sensor of the test device (this need not be considered in the case of the reference junction model 4485).

Selection of the thermocouple

- Press the **FCT** and **TC** keys. The "TC selection" display appears.
- Using the **→** or **←** key, select the desired thermocouple.

Selection of the reference junction

- After that, press the **▲** or **▼** key and select "Transmit:XXXX".
- Then use the **→** or **←** key to select "Transmit:TC+RJ-AUT".
- Acknowledge with **ENT**.

Selection of the unit

- After pressing the **FCT** and **UNIT** keys, set the correction cursor using the **▲** or **▼** key to TC.
Using the **→** or **←** key, select °C, °F or K.
- Acknowledge with **ENT**.

Selection of the "TC: Thermocouple simulation" mode

- If the device is in the "IN" measurement mode, first switch it to the "OUT" transmission mode by pressing the **IN/OUT** key.
- By pressing **TC** you can then invoke the set transmission mode "RJ:AUT".

4.3.3.4 TC+0-20mA: Simulating a thermocouple with a linear response voltage transducer. Rated output-current range: 0-20mA.

The DIGISTANT® simulates a thermocouple with a series-connected U/I transducer. This transducer converts the output voltage of the simulated thermocouple linearly into a current, which the DIGISTANT® supplies at its output sockets.

To be able to calculate the output current from the simulated temperatures, the DIGISTANT® requires

- the temperature corresponding to the lowest current value (4 mA) and
- the temperature corresponding to the highest current value (20 mA).

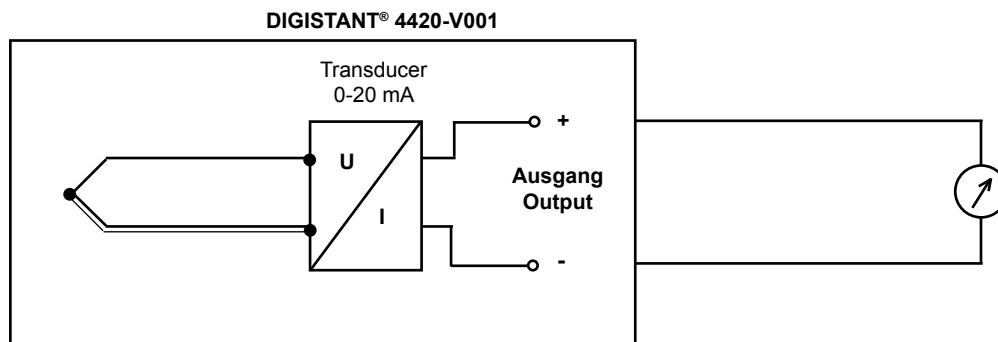

- Switch on the device and connect it as shown below.

Selection of the thermocouple

- Press the **FCT** and **TC** keys. The "TC selection" display appears.
- Using the **→** or **←** key, select the desired thermocouple.

Selection of the reference junction

- After pressing the ▲ or ▼ key and select "Transmit:XXXX".
- Then use the → or ← key to select "Transmit:TC+4-20mA".
- Acknowledge with (ENT).
- The temperature values last allocated to the current values of 4 mA and 20 mA are then displayed.
Modify the temperature limits or acknowledge the present entry with (ENT).

Modification of the temperature limits

- The correction cursor indicates the temperature limit which can be modified.
You can move the correction cursor up with ▲ and down with ▼.
- Enter the new temperature values and acknowledge the entry with (UNIT).
- Complete your modification of the temperature limits with (ENT).
- Values can be entered and allocated in the "OUT" and "IN" modes. However, these values are stored only once and used jointly for both operating modes. In other words, the entered temperature limits are applicable to "OUT-TC" as well as "IN-TC".

Selection of the unit

- After pressing the (FCT) and (UNIT) keys, set the correction cursor using the ▲ or ▼ key to TC.
Using the → or ← key, select °C, °F or K.
- Acknowledge with (ENT).

Selection of the "RJ:0-20mA" transmission mode

- If the device is in the "IN" measurement mode, first switch it to the "OUT" transmission mode by pressing the (IN/OUT) key.
- By pressing (TC) you can then invoke the set transmission mode "TC: X RJ:0-20mA".

4.3.3.5 TC+0-20mA: Simulating a thermocouple with a linear response voltage transducer. Rated output-current range: 0-20mA.

- Switch on the device and connect it as shown below..

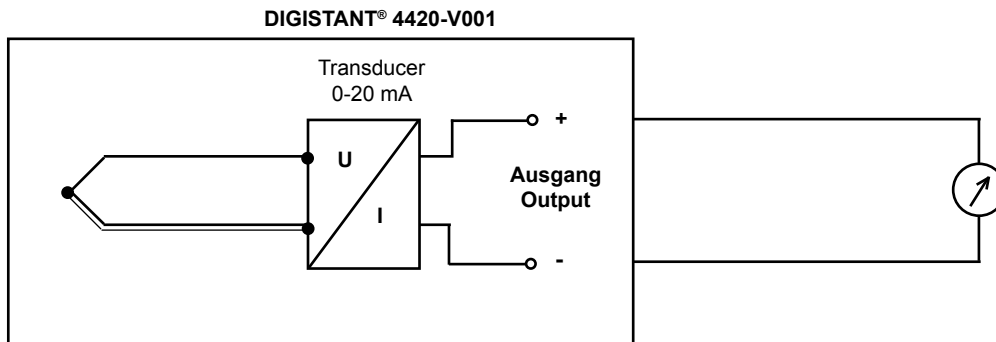





Selection of the thermocouple

- Press the **(FCT)** and **(TC)** keys. The "TC selection" display appears..
- Using the **(→)** or **(←)** key, select the desired thermocouple.







Selection of the reference junction

- After that press the **(▲)** or **(▼)** key and select "Transmit:XXXX".
- Then use the **(→)** or **(←)** key to select "Transmit:TC+0-20mA".
- Acknowledge with **(ENT)**.
- The temperature values last allocated to the current values of 0 mA and 20 mA are then displayed.
- Modify the temperature limits or acknowledge the present entry with **(ENT)**.



Modification of the temperature limits

- The correction cursor indicates the temperature limit which can be modified. You can move the correction cursor up with  and down with .
- Enter the new temperature values and acknowledge the entry with .
- Complete your modification of the temperature limits with .
- Values can be entered and allocated in the "OUT" and "IN" modes. However, these values are stored only once and used jointly for both operating modes. In other words, the entered temperature limits are applicable to "OUT-TC" as well as "IN-TC".

Selection of the unit

- After pressing the  and  keys, set the correction cursor using the  or  key to TC.
- Using the  or  key, select °C, °F or K.
- Acknowledge with .

Selection of the "RJ:0-20mA" transmission mode

- If the device is in the "IN" measurement mode, first switch it to the "OUT" transmission mode by pressing the  key.
- By pressing  you can then invoke the set transmission mode "TC: X RJ:0-20mA".

4.3.4 Temperature simulation with a Pt100/200/500/1000 and Ni100

Connect the DIGISTANT® in:

2 wire configuration

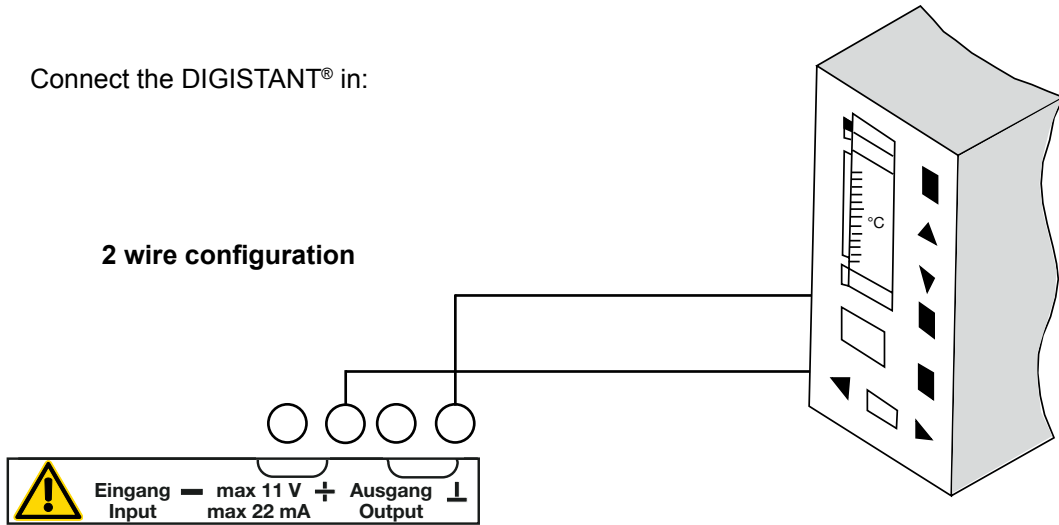

3 wire configuration

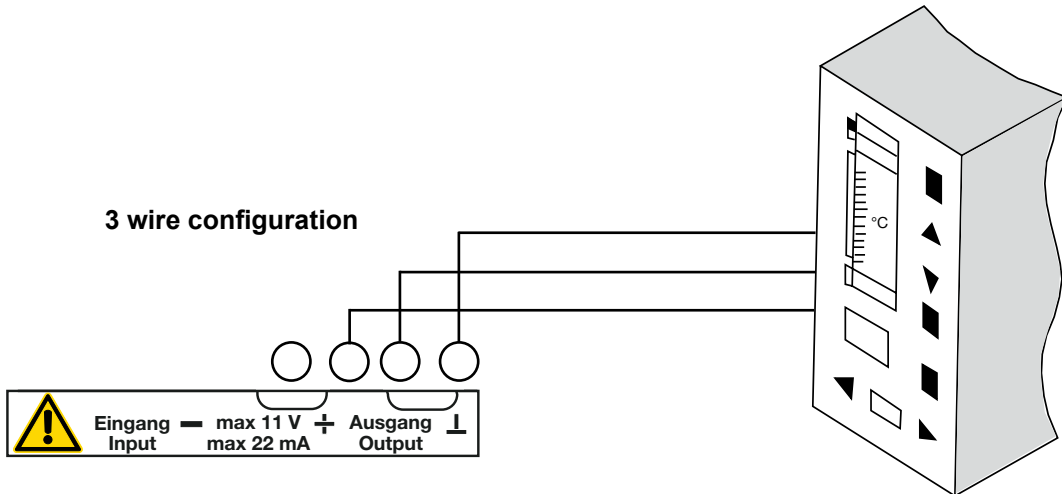

or 4 wire configuration.

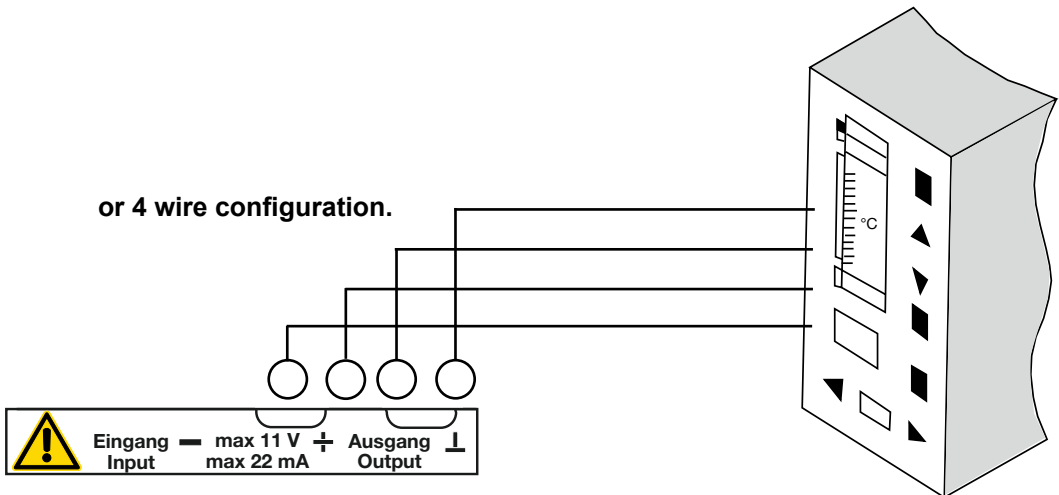

Switch on the device and connect it as shown above.

4.3.4.1 Settings for resistance-thermometer simulation

This menu is obtained by selecting the [FCT] and [RTD] functions.

The following display appears on the LCD:

			R	T	D	-	S	E	T	T	I	N	G						
	R	T	D	:															

Various parameters for RTD measurement and transmission are set in this menu.

The different parameters are selected with the ▲ and ▼ cursor keys.

RTD selection

- The → and ← keys are used to toggle between the following RTD types:

- Pt100 (Pt100 is selected)
- Ni100 (Ni100 is selected)
- Pt200 (Pt200 is selected)
- Pt500 (Pt200 is selected)
- Pt1000 (Pt1000 is selected)

RL-OUT setting

- Here, you can specify whether or not the lead resistance RL should be considered for RTD transmission.

- The → and ← keys can be used to toggle between the following options:

- ON RL is added to the RTD transmission value
- OFF RL is not considered.

RL-IN setting - No setting is required for simulation.

RL entry

- The lead resistance (for RTD transmission and measurement) can be adjusted over a value range of 1 Ω to 99 Ω with the 0-9 number keys.

- Press the ENT key to save the new RTD setting and return to the measurement or transmission mode.

Selection of the unit

- After pressing the **FCT** and **UNIT** keys, set the correction cursor using the **▲** or **▼** key to RTD.
Using the **→** or **←** key, select °C, °F, Ω or K.
- Acknowledge with **ENT**.

Selection of the "RTD:XXXX" transmission function

- If the device is in the "IN" measurement mode, first switch it to the "OUT" transmission mode by pressing the **IN/OUT** key.
- By pressing **RTD** you can then invoke the set transmission mode "RTD:XXXX".
- Using the **0**–**9** number keys, you can now enter the desired value.
- Complete your entry with **UNIT**.

4.3.4.2 Resistance simulation

After pressing the **FCT** and **UNIT** keys, set the correction cursor using the **▲** or **▼** key to RTD.



Using the **→** or **←** key, select the Ω unit.

Acknowledge with **ENT**.

RTD setting

- This menu is obtained by pressing the **FCT** and **RTD** keys.
the following display appears on the LCD:



			R	T	D	-	S	E	T	T	I	N	G							
			R	T	D	:														

- Various parameters for RTD measurement and transmission are set in this menu.
- The different parameters are selected with the  and  cursor keys.

RTD selection

- If the Ω unit has been chosen, resistance simulation is possible with all RTD types.



RL-OUT setting

- Here, you can specify whether or not the lead resistance RL should be considered for RTD or resistance simulation.
- The  and  keys can be used to toggle between the following options:





ON RL is added to the RTD transmission value
OFF RL is not considered.

RL-IN setting - This setting is not required for simulation.

RL entry

- The lead resistance (for RTD transmission and measurement) can be adjusted over a value range of 1 Ω to 99 Ω with the - number keys.
- Press the  key to save the new settings.

Selection of resistance simulation

- If the device is in the "IN" measurement mode, first switch it to the "OUT" transmission mode by pressing the  key.
- By pressing  you can then invoke the set transmission mode "Resistance simulation".
- Using the - number keys, you can now enter the desired value.
- Complete your entry with .

4.4 Power-on/power-off

- The 4420-V001 is switched on and off with the  key.
- This key has a toggle function.

Pressing the key effects power-off immediately, as it is not controlled by the built-in micro controller.
- When switched on, the device assumes the state it was in immediately before being switched off.

4.5 Changeover between measurement and transmission

- Changeover between measurement and transmission is effected with the  key.
- In the measurement mode, the 4420-V001 invokes the function which was last performed in the transmission mode, and vice versa.





Example:

If the  key is operated while a current value is outputted, the 4420-V001 switches over to current measurement.

4.6 Transmission mode





- Prerequisite: The device must be in the transmission mode; if not, press the  key.
- The LCD might show the following display, for example:













			O	U	T			-	1	0	.	2	3	5			m	A	

- A new transmission value is entered with the - number keys, the  sign key and the  decimal-point key.
- A maximum of 5 digits can be entered.
- When a new entry is made, the display of the previous transmission value in the 1st row of the LCD extinguishes and is replaced by a display of the present entry:

			O	U	T				5	.	3	4							

- The present entry can be cancelled with the  cancel key.
- The previous transmission value is displayed again in the 1st row of the LCD.
- Entries are completed with the unit keys:

1.  key: A current value is output.
2.   keys: A voltage value is output
3.  key: A TC or an RTD is simulated, depending on the setting. The  key can be assigned to different units:
 - for TC: K, °C, °F;
 - for Rtd: K, °C, °F and Ω.
 These assignments are carried out in a function menu.

- If the entered transmission value is valid, it is output and displayed in the 1st row of the LCD.
- Invalid transmission values generate an error message.
In case of an error:
 1. Press the  key. The previous transmission value is output and displayed again.
 2. Commence a new entry.
- Pressing a unit key once causes a value of 0 to be output in the applicable transmission mode.
- Key combination  and  :
The sign of the present transmission value is inverted. This function is only available for I and U transmission.
-  key: The device assumes the TC transmission mode. The value output last in this mode is output here again.
-  key: The device assumes the RTD transmission mode. The value output last in this mode is output here again.
-  key: A dX-value entered in a function menu is added to the present transmission value. If the result is valid, it is output.
-  key: A dX-value entered in a function menu is subtracted from the present transmission value. If the result is valid, it is output.
-  key: The device assumes the applicable measurement mode.
-  key: A function is selected.
-  key: A value-pair (transmission and dX values) is stored.
-  key: A value-pair (transmission and dX values) is retrieved.
The value fetched from the memory is output.
-  key: The ramp function is invoked.
-  key: The background illumination is switched on/off.



















4.7 Selecting a function

Functions are selected by pressing the  key in the measurement or transmission mode.

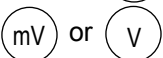
 key: This key effects a return to the measurement or transmission mode without a function having been selected.



 key: This key turns the background illumination on and off.

There are two possibilities of invoking special functions:

a) Direct selection	Function selected:
 key	dX-setting
 key	RS232-setting
 key	Min./Max. function
 key	Display of software version and calibration status
 key	Range selection for RTD transmission (automatic or manual)
 key	Storage and retrieval of device settings
 key	Setting of the LCD display contrast
 key	Setting of the ground connection
 key	Setting of the date and time
 key	Display of the date and time
 key	Setting of the units for TC and RTD
 key	Rtd selection (Pt100, Ni100, Pt200, Pt 500 or Pt1000)
 key	Selection of the TC type and RJ
 key	Range selection for U transmission (automatic or manual)
 key	Data-logger setting
 key	Data-logger evaluation
 key	Ramp setting
 key	Setting of transmission or measurement
 key	Setting the duration of the background illumination
 key	Range selection for I transmission (automatic or manual)

a) Indirect selection

Function selected:

The functions can also be selected indirectly by operating the  or  key.

This invokes the menu for indirect selection.

The following display appears on the LCD:

>		d	X	-	S	E	T	T	I	N	G							
		R	S	2	3	2	-	S	E	T	T	I	N	G				

The functions can be scrolled through with the  and  cursor keys.



key: The function marked with the  cursor symbol in the first column can be selected by pressing the ENTER key.
The corresponding menu is displayed on the LCD.



key: This key can be used to cancel an entry without a function having been selected.
A return is effected to the transmission or measurement menu, depending on where the function was invoked from.



key: This key can be used to cancel an entry without a function having been selected.
A return is effected to the transmission or measurement menu, depending on where the function was invoked from.

4.8 dX-setting

This menu is obtained by pressing the **FCT** and **0** keys.
The LCD provides the following display, for example:

d	X	-	S	E	T	T	I	N	G								
>	U	:				5	.	2	3	4		m	V				

The **▲** and **▼** cursor keys can be used to scroll through the various dX-values belonging to the respective transmission mode if no current entry is active.

The currently selected dX-value is identified with a mark in the 2nd row of the LCD.

Sample displays:

>	U	:				5	.	2	3	4		m	V				
---	---	---	--	--	--	---	---	---	---	---	--	---	---	--	--	--	--

dX-value for U transmission

>	I	:				1	2	.	4	8	6		m	A			
---	---	---	--	--	--	---	---	---	---	---	---	--	---	---	--	--	--

dX-value for I transmission

>	T	C	:			1	2	3	.	8		°	C				
---	---	---	---	--	--	---	---	---	---	---	--	---	---	--	--	--	--

dX-value for TC transmission

>	R	T	D	:		2	0	0	.	4	3		Ω				
---	---	---	---	---	--	---	---	---	---	---	---	--	---	--	--	--	--

dX-value for RTD transmission

Using the **0**–**9** number keys and the **▪** decimal-point key, the selected dX-value can be newly entered.

Current entries are completed with the corresponding units key:

mV or **V** key: dX-values for U transmission.

mA key: dX-values for I transmission.

UNIT key: dX-values for TC and RTD transmission.

The meaning of the key depends on its assignment which can be made in a function menu.

K, °C or °F for TC and K, °C, °F or Ω for RTD transmission.

Current entries can be cancelled with the **C** key.

ENT key: If no current entry is active, the **ENT** key can be pressed to return to the transmission or measurement menu.

4.8.1 Storing a value-pair

This menu is obtained by pressing the $\text{STO} \rightarrow$ key in the transmission mode. In addition to the present transmission value in the 1st row, the dX-value is displayed in the 2nd row of the LCD:

			O	U	T		-	1	0	.	2	3	5			m	A	
S	T	O		d	X					1	.	5	6	4			m	A

By pressing one of the $\text{0} - \text{9}$ number keys, the value-pair (transmission value and dX-value) can be stored under one of the 10 memory numbers 0 to 9. After that, a return is effected to the transmission mode.

Pressing the C key effects a return to the transmission mode without prior storage of the value-pair.

4.8.2 Retrieving a value-pair

This menu is obtained by pressing the $\text{RCL} \leftarrow$ key in the transmission mode. In addition to the present transmission value in the 1st row, the RCL mode is displayed in the 2nd row of the LCD:

			O	U	T		-	1	0	.	2	3	5			m	A	
R	C	L																

Pressing the C key effects a return to the transmission mode without retrieval of a value-pair from the memory.

Memory locations can be selected directly or indirectly.

a) Direct selection

By pressing one of the $\text{0} - \text{9}$ number keys, the value-pair (transmission value and dX-value) stored at the corresponding memory location can be retrieved. After that, a return is effected to the transmission mode.

b) Indirect selection

One of the two cursor keys must be pressed for indirect selection.

The transmission and delta-X values at memory location 0 are displayed.



0			O	U	T			1	.	2	3	4	5		V			
R	C	L		d	X			1	2	.	2	1	8		m	V		

By operating the two cursor keys, the value-pairs at the 10 memory locations (0 to 9) can be scrolled through. They are displayed with their respective location numbers on the LCD.

Press the C key to cancel your entry. No value-pair is fetched from the memory. The original, currently selected values are displayed again on the LCD.



Press the ENT key to acknowledge the currently selected value-pair.

4.9 Ramp function



This menu is obtained by pressing the  and  keys.
 The LCD provides the following display, for example:

			R	A	M	P		F	U	N	C	T	I	O	N			
	R	A	M	P		1												

The currently selected ramp type is shown in the 2nd row.

The  and  keys can be used to toggle between RAMP 1 and RAMP 2.

 key: This key effects a return to the measurement or transmission menu.

 and  keys: The currently selected ramp type is activated. By pressing the cursor keys, various setting parameters can be scrolled through, depending on the ramp type. The different parameters are displayed in the 2nd row together with their present settings. (Exception: dWi and dti, see below)

Difference between RAMP 1 and RAMP 2

	RAMP 1	RAMP 2
Number of stages:	Depending on resolution	Max. 30
dt for each stage	Constant for all stages	Variable for each stage
Delta transmission value	Constant for all stages	Variable for each stage
Physical variable for each stage	Voltage, current, Thermocouple or RTD	Voltage, current Thermocouple and RTD
Type of ramp sequence	Triangle or sawtooth	Triangle or sawtooth
Number of passes	1 to 99 or continuous	1 to 99 or continuous

Due to their different characteristics, the two ramp types need to be described with two different parameter entries.

4.9.1 Use of the ramp function

The ramp function can be activated by pressing the  key in the normal transmission mode. Only then is it possible to execute a ramp sequence (automatic or single-step).

			O	U	T		-	2	.	3	4	5		m	V				
																	R	O	

Display when a ramp has stopped

Indication of a stopped ramp: RO in the 2nd row of the LCD.

The ramp is started with the  key.

			O	U	T		1	0	.	4	5		m	V				
d	t	:				1	2	.	4		s					R	1	

Display when a ramp has started

Indication of a started ramp: R1 in the 2nd row of the LCD.

At time intervals of ≥ 3 s, the current transmission value is displayed in the 1st row.



The time remaining for the current stage is counted down in 1/10 seconds and displayed in the 2nd row of the LCD.

At time intervals of < 3 s, only the transmission value is displayed without the remaining time on the LCD.

On the "continuous" setting, the ramp can be stopped by pressing the  key again.

Even if a limited number of passes has been set, the ramp can be cancelled prematurely by pressing the  key.

If the ramp is cancelled with the  key, the last value supplied by the ramp is retained. The ramp is thus restarted with the current transmission value instead of beginning automatically with the initial value.

In the stopped state, the ramp sequence can be executed in single steps in both directions using the  and  cursor keys.

During single-step execution of the ramp sequence, the current transmission value is displayed in the 1st row of the LCD.

By pressing the  key once more, the ramp function can be deactivated again.

The current transmission value is retained.

Entry for selecting ramp 1

Parameter list :	RAMP 1	
	SEQUENCE	
	N	Number of passes
	AW	Initial value
	EW	Final value
	dW	Delta transmission value
	dt	Delta time

Using the \leftarrow and \rightarrow keys, the sequence can be toggled between the following values:
SAWTOOTH

TRIANGLE

The number of passes (N) can be entered using the number keys over a value range of 0 to 99. 0 implies continuous operation. After pressing the \square key, a new entry can be made.

The initial value (AW) is entered with the \bigcirc_0 – \bigcirc_9 number keys, the \bigcirc_{\cdot} decimal-point key and the \bigcirc_{\pm} sign key.

The final value (EW) is entered with the \bigcirc_0 – \bigcirc_9 number keys, the \bigcirc_{\cdot} decimal-point key and the \bigcirc_{\pm} sign key.

The delta transmission value (dW) is entered with the \bigcirc_0 – \bigcirc_9 number keys and the \bigcirc_{\cdot} decimal-point key.
Only positive values can be entered.

The delta time (dt) is entered in seconds using the \bigcirc_0 – \bigcirc_9 number keys and the \bigcirc_{\cdot} decimal-point key.

(resolution: 200 ms; value range: 0.2 s to 99999.9 s). After pressing the \bigcirc_C key, a new entry can be made.

A current entry can be cancelled with the \bigcirc_C key. The previous value then appears on the display.

An entry is completed with the corresponding units key, causing the value to be saved. When inserting RTD or TC values must with pressures of the keys "RTD" or "TC" be locked. Whereby the current attitude of RTD or TC is taken over. Invalid entries generate an error message (invalid value range).

The error message must be acknowledged by pressing the \bigcirc_C key (the previous value is then displayed) or by a new entry.

\bigcirc_{ENT} key:

On exiting with the \bigcirc_{ENT} key, a check is made as to whether the initial, final and delta values were entered with the same unit. If an error has occurred, it is displayed.

Wrong entries must be corrected, otherwise it is not possible to exit the function with this key.

Entry for selecting ramp 2

Parameter list: RAMP 2
 SEQUENCE
 N number of passes
 S number of stages
 Wi, ti value and time of the i-th stage for $1 \leq i \leq 30$

On the selection of SEQUENCE, N and S, the respective parameter is displayed in the 2nd row. The SEQUENCE and the number of passes (N) are entered as for RAMP 1. The number of stages (S) can be set with the number keys in a value range between 2 and 30. New entries can be made after pressing the **C** key. On the selection of Wi and ti, the value of Wi is displayed in the 1st row and the value of ti is displayed in the 2nd row.

>	W	1	4	:		1	8	.	3	6	3		m	V					
	t	1	4	:		8	.	4											S

▲ and **▼**-keys: The cursor keys are used to change between the parameters. If the cursor is on Wi, the cursor-down key selects ti (cursor on ti) and the cursor-up key selects the S parameter:

			R	A	M	P		F	U	N	C	T	I	O	N				
	S	2	:				2	4											

If the cursor is on ti, the cursor-down key is used to select RAMP 2.

			R	A	M	P		F	U	N	C	T	I	O	N				
	R	A	M	P		2													

Again, if the cursor is on ti, the cursor-up key is used to select Wi (cursor on Wi).

The current Wi and ti parameters are marked with the "->" cursor symbol. In the case of Wi as well as ti, the i-value can be set over a range of $1 \leq i \leq 30$ using the [→] and [←]-keys .

The Wi-value is entered with the **0**–**9** number keys, the **P** decimal-point key and the **±** sign key.

A current entry can be cancelled with the **C** key. The previous value then appears on the display.



An entry is completed with the corresponding units key, causing the value to be saved. When inserting RTD or TC values must with pressures of the keys "RTD" or "TC" be locked. Whereby the current attitude of RTD or TC is taken over. Invalid entries generate an error message (invalid range). The error message must be acknowledged by pressing the **C** key (the previous value is then displayed) or by a new entry.

The time (ti) is entered in seconds with the **0**–**9** number keys and the **P** decimal-point key (resolution: 200 ms; value range 0.2 s to 99999.9 s).

A new entry can be made after pressing the **C** key.

ENT key: This key effects a return to the measurement or transmission mode.

4.10 Setting simultaneous transmission and measurement





This menu is obtained by pressing the  and  keys.
The following display appears on the LCD:

>		T	R	A	N	S.	+	M	E	A	S.	:		O	F	F			
		M	E	A	S.			M	O	D	E	:		U					

In this menu, you can specify whether measurements should be carried out simultaneously in the transmission mode. The variable to be measured can also be specified here.

The 1st row indicates whether the function is active or inactive.

The 2nd row indicates the selected measurement mode.

-  key: This key effects a return to the measurement or transmission mode.
-  and  keys: These keys are used to jump between the 1st and 2nd rows. The selected row is marked with the  cursor symbol.

The parameter in the selected row can be changed.

Setting TRANSMISSION + MEASUREMENT

Press the  and  keys to toggle between the following options:

- ON (transmission + measurement function is active)
- OFF (transmission + measurement function is inactive)

Setting the MEASUREMENT MODE

Press the  and  keys to toggle between the following options:

- MEAS. MODE: I (current measurement)
- MEAS. MODE: U (voltage measurement)
- MEAS. MODE: RTD (Pt100, Ni100, Pt200, Pt500 bzw. Pt1000 measurement) **
- MEAS. MODE: TC (thermocouple measurement)



****Warning:** Simultaneous transmission and measurement of RTD with a direct connection (between the RTD input and output in the case of the DIGISTANT 4420-V001) leads to measurement errors and should be **avoided**.

External applications without an electrical connection, e.g. Pt-100 simulation for a controller and simultaneous temperature measurement with an integrated, electrically isolated Pt100 sensor do not pose any problems in this respect.

4.10.1 Simultaneous transmission and measurement

Here, the measurement mode is a fixed selection in the function menu. The transmission values can be changed. The LCD provides the following display, for example:

			O	U	T		-	2	.	3	4	5		m	V				
																	R	O	

The entry corresponds to that in the transmission mode, except that the  key cannot invoke the ramp function and the  key cannot be used to switch to the measurement mode.

4.11 Setting the data logger

This menu is obtained by pressing the **FCT** and **STO** keys.
The following display appears on the LCD:

4.11.1 Setting the storage time

D	A	T	A	L	O	G													
	T	I	M	E	:					1	2	0	0		s				

The menu for entering the time interval at which measurement data should be written in the data logger's memory appears first.

- 0-9** keys: A new time value can be entered with the number keys 0 to 9. Value range: 0 to 3600 s
- C** key: The current entry can be cancelled with this key.
- ENT** key: By pressing this key, the newly entered time value is saved and a return is effected to the measurement or transmission menu.
- ▲** key: By pressing this key, the newly entered time value is saved and the menu for erasing the data logger's entire memory appears.
- ▼** key: By pressing this key, the newly entered time value is saved and the menu for erasing individual blocks of the data logger's memory appears.

4.11.2 Data logger mode

The data logger mode is invoked by pressing the **STO** key in the measurement mode. The data logger mode is indicated in the 2nd row of the LCD.
The stopped state is indicated by a 0 and the started state by a 1. In addition, the number of free memory locations (e.g. 214) and the current block number (e.g. 101) are displayed.

			I	N				1	0	.	2	3	5			m	A		
D	A	T	A	L	O	G		1	0	1		0		2	1	4			

Data logger in the stopped state

- 1/0** key: Pressing this key starts automatic data recording. The following display appears:

			I	N				1	0	.	2	3	5			m	A		
D	A	T	A	L	O	G		1	0	1		0		2	1	4			

Data logger in the started state

Pressing this key again stops automatic data recording.

The $\text{\textcircled{1/0}}$ key thus has a toggle function.

$\text{\textcircled{\blacktriangle}}$ key: If automatic data recording has not been started, this key can be pressed to record single values.

$\text{\textcircled{C}}$ key: If automatic data recording has not been started, this key can be pressed to delete the measurement value recorded last by the data logger.

The data logger's memory has a capacity of 256 values. When the memory becomes full, any data recording still in progress is stopped and the following message appears on the LCD:

			I	N				1	0	.	2	3	5			m	A	
	D	A	T	A		L	O	G	G	E	R		F	U	L	L		

This indicates that the data logger's memory is full

$\text{\textcircled{\rightarrow STO}}$ key: If automatic data recording has not been started, pressing this key effects a return to the normal measurement mode.

4.11.3 Erasing the data logger's memory

a. Erasing the memory completely

This menu is obtained by pressing the $\text{\textcircled{FCT}}$ and $\text{\textcircled{\rightarrow STO}}$ keys. After that, press the $\text{\textcircled{\blacktriangledown}}$ key.

The following display appears:

D	A	T	A	L	O	G												
	E	R	A	S	E	:		N	O									

In this menu, the data logger's memory can be erased completely.

To be able to erase the memory, enter the number -2609- in the above display.

The following display then appears:

D	A	T	A	L	O	G												
	E	R	A	S	E			Y	E	S								

YES (erase memory) -2609-
 NO (do not erase memory) - continue on p. 4-41 *

b. Erasing the memory in blocks



This menu is obtained by pressing the $\text{\textcircled{FCT}}$ and $\text{\textcircled{\rightarrow STO}}$ keys. After that, press the $\text{\textcircled{\blacktriangle}}$ key.

The following display appears, for example:

	B	L	O	C	K	:				1	0								
>	E	R	A	S	E	:				N	O								

In this menu, the data logger's memory can be erased in blocks.

Set the cursor to the "BLOCK" parameter with the  key.

The block to be erased can now be selected with the  or  key.

After that, set the cursor with the  key back to "ERASE".



To be able to erase the memory block, you must enter the number -2609- in the above display.

The following display then appears, for example:

B	L	O	C	K	:					5									
>	E	R	A	S	E	:				Y	E	S							

YES (erase memory) -2609

NO (do not erase memory)

- *_ for a. and b.
-  key: If YES was selected, pressing this key erases the data logger's memory and effects a return to the measurement or transmission menu.
 -  key: If YES was selected, pressing this key erases the data logger's memory and invokes the menu for erasing individual blocks of the data logger's memory.
 -  key: If YES was selected, pressing this key erases the data logger's memory and invokes the menu for setting the storage time.

4.11.4 Data logger evaluation



This menu is obtained by pressing the  and  keys.

The following display appears on the LCD:

			D	A	T	A		L	O	G	G	E	R	V	A	L	U	E	S
			M	E	A	S.		V	A	L	U	E	S						



Setting the type of evaluation

In this menu, the type of data logger evaluation is selected and indicated in the 2nd row of the LCD.

 and  keys: These keys can be used to toggle between the following values:

MEAS. VALUE (displays the individually recorded measurement values)
 STATISTICS (statistical evaluation in blocks)

 key: This key effects a return to the measurement or transmission menu.

 and  keys: Depending on the selected type of evaluation, pressing this key invokes either the menu for displaying the recorded measurement values or the statistics menu.

4.11.5 Statistical evaluation

>	B	L	O	C	K	:				1	4						
	M	I	N	:						1	1	.	2	5	7		m V

In the 1st row: the selected block is displayed.
 In the 2nd row: the type of statistical evaluation is displayed together with the corresponding calculated value.

Row 1 or 2 of this menu can be selected using the ▲ and ▼ keys. The selected row is marked by the → cursor symbol.

▼ key: If the cursor symbol is in the BLOCK row, pressing this key moves the symbol to the 2nd row (type of statistic).
 If the cursor symbol is in the 2nd row, pressing this key invokes the menu for selecting the type of evaluation.

▲ key: If the cursor symbol is in the BLOCK row, pressing this key invokes the menu for selecting the type of evaluation.
 If the cursor symbol is in the 2nd row, pressing this key moves the symbol to the BLOCK row .

The parameter selected and marked with the → cursor symbol can be changed.

4.11.6 Display of the recorded values

1	4	.	1	0	.	9	4			0	7	:	2	4	:	1	5		
1	2			1	3	4				-	1	4	.	2	3	4		m V	

The display is to be interpreted as follows:

In the 1st row: the date and time of recording of the relevant measurement value are displayed.

In the 2nd row: the block number (12), sequential number (134) and measurement value (-14.234 mV) are displayed.

← and → keys: These keys can be used to scroll through the individually recorded values.

0-9 keys: The number keys can be used to enter a measurement value number directly. During this entry, the display is cleared except for the sequential number.

ENT key: 1. Completes the entry of a sequential number.
 2. Otherwise effects a return to the transmission or measurement menu.

▲ and ▼ keys: Pressing these keys invokes the menu for selecting the type of output.

4.12 Setting the RS232 interface

This menu is obtained by pressing the **FCT** and **1** keys.

The LCD provides the following display, for example:

R	S	2	3	2		I	N	T	E	R	F	A	C	E				
B	A	U	D			R	A	T	E	:		9	6	0	0			

In the 2nd row, the currently selected interface parameter is displayed together with its present setting.

Using the **▲** and **▼** cursor keys, the following parameters can be selected:

RS232:	(activates/deactivates the interface)
BAUD RATE:	(sets the baud rate)
DATA BITS:	(sets the number of data bits)
STOP BITS:	(sets the number of stop bits)
PARITY:	(sets the type of parity)
GROUP ADDR.:	(for entering the group address)
USER ADDR.:	(for entering the user address)
CHAR. DELAY:	(activates/deactivates the character delay)
BLOCK CHECK:	(activates/deactivates the block check)

Pressing the **ENT** key sets the interface with the current parameters and effects a return to the measurement or transmission mode.

Entries for the BAUDRATE parameter:

Use the **←** and **→** keys to toggle the baud rate between the following values:

19200
9600
4800
2400
1200
600
300

Entries for the DATA BITS parameter:

The number of data bits can be toggled with the **→** and **←** keys between the following values:

8
7

Entries for the STOP BITS parameter:

The stop bits can be toggled with the **→** and **←** keys between the following values:

1
2

Entries for the PARITY parameter:

The parity can be toggled with the \rightarrow and \leftarrow keys between the following values:
 EVEN
 ODD
 NONE

Entries for the GROUP ADDR. parameter:

The group address can be set over a value range of 0 to 15 with the number keys.

Entries for the USER ADDR. parameter:

The user address can be set over a value range of 0 to 15 with the number keys.

Entries for the CHAR. DELAY parameter:

The character delay can be toggled with the \rightarrow and \leftarrow keys between the following options:
 OFF (character delay is inactive)
 ON (character delay is active)

Entries for the BLOCK CHECK parameter:

The block check can be toggled with the \leftarrow and \rightarrow keys between the following options:
 OFF (block check is inactive)
 ON (block check is active)

4.13 Min./max function

This menu is obtained by pressing the FCT and 2 keys.
 Here, you can specify whether or not the minimum and maximum values should be recorded while a measurement is in progress.
 If the min./max. function is active, the min. and max. values in the measurement mode are displayed in the 2nd. row.

The following display appears on the LCD:



		M	I	N	/	M	A	X		F	U	N	C	T	I	O	N		
		M	I	N	/	M	A	X	:				O	F	F				

The ENT key effects a return to the measurement or transmission mode.

The MIN./MAX. function can be toggled with the \leftarrow and \rightarrow keys between the following options:

OFF (MIN./MAX. recording is inactive)
 ON (MIN./MAX. recording is active)

4.14 Display of the version and calibration stage

This menu is obtained by pressing the  and  keys.
The LCD provides the following display, for example:

V	E	R	S	I	O	N	:	V	0	3	9	4						
C	A	L	:					C	0	0	1							



In the 1st row: the software version is indicated.

In the 2nd row: the number of calibrations is indicated.
000 means that the device has not been calibrated yet.
This value is incremented after every calibration.

The  key effects a return to the measurement or transmission mode.

Calibration can only be controlled via one of the external interfaces.



4.15 Adjusting the background illumination

This menu is obtained by pressing the  and  keys.
The following display appears on the LCD:

	D	I	S	P	L	A	Y		L	I	G	H	T	I	N	G		
L	I	G	H	T	I	N	G		T	I	M	E		1	9		s	

In this menu, the duration of the background illumination can be set.
The background illumination can be activated in every menu by pressing the  key.

The background illumination goes off when the  key is pressed again or when the lighting time set in this menu has elapsed.

The LIGHTING TIME can be set with the - number keys over a value range of 1 to 60 s.

Pressing the  key saves the newly entered value and effects a return to the measurement or transmission mode.

Pressing the  key deletes the newly entered value and restores a display of the previous value on the LCD.

 key: Activates/deactivates the background illumination.

4.16 RTD setting

This menu is obtained by pressing the **FCT** and **RTD** keys.
The LCD provides the following display, for example:

			R	T	D	-	S	E	T	T	I	N	G						
	R	T	D	:							P	T	1	0	0				

Various parameters for RTD measurement and transmission are set in this menu.

The following parameters can be selected with the **▲** and **▼** cursor keys.

RTD selection:

The **→** and **←** keys are used to toggle between the following RTD types:

- Pt100 (Pt100 is selected)
- Ni100 (Ni100 is selected)
- Pt200 (Pt200 is selected)
- Pt500 (Pt500 is selected)
- Pt1000 (Pt1000 is selected)

RL-OUT setting:

Here, you can specify whether or not the lead resistance RL should be considered for RTD transmission.

The **→** and **←** keys can be used to toggle between the following options:

- ON RL is subtracted from the RTD measurement value
- OFF RL is not considered.

RL entry:

The lead resistance (for RTD transmission and measurement) can be adjusted over a value range of 1 Ω bis 99 Ω with the **0**–**9** number keys.

Press the **ENT** key to save the new RTD setting and return to the measurement or transmission mode.

4.17 Setting the TC type and RJ

This menu is obtained by pressing the **FCT** and **TC** keys .

The following display appears on the LCD:

In this menu, the TC type, reference junction (RJ) for TC measurement and RJ for TC transmission are set.

Setting the TC type

After the function has been selected, the menu for setting the TC type first appears:

				T	C	-	S	E	L	E	C	T	I	O	N				
	T	C	:									R							

Selection of the TC type

Press the **←** and **→** keys to choose between the following TC types:

R, S, B, J, T, E, K, U, L, N, C, D, G2, M

Pressing the **ENT** key effects a return to measurement or transmission mode.

Pressing the **▲** key calls up the menu for setting the reference junction (RJ) for TC transmission.

Pressing the **▼** key calls up the menu for setting the reference junction (RJ) for TC transmission.

4.17.1 Setting the reference junction (RJ) for TC transmission

The following display appears on the LCD:

				R	J	-	S	E	L	E	C	T	I	O	N					
	T	R	A	N	S.	:					T	C	+		R	J	-	M	A	N

Press the **←** and **→** keys to choose one of the following reference junctions:

TC

TC + RJ-MAN

TC + RJ-AUT

TC + 4-20 mA

TC + 0-20 mA

Key: **ENT** If TC or TC+RJ-AUT is selected, a return is effected to measurement or transmission mode. If TC+RJ-MAN is selected, the menu for entering the reference-junction temperature is called up.

If TC+4-20mA is selected, the menu for entering the temperatures at 4 mA & 20 mA is called up.

If TC+0-20mA is selected, the menu for entering the temperatures at 0 mA & 20 mA is called up.

Pressing the **▼** key calls up the menu for setting the reference junction (RJ) for TC measurement.

Pressing the **▲** key calls up the menu for setting the TC type.

4.17.2 Setting the reference junction (RJ) for TC measurement

The following display appears on the LCD:

								R	J	-	S	E	L	E	C	T	I	O	N
	M	E	A	S.		:		R	J	-	M	A	N						

Press the \leftarrow and \rightarrow keys to choose one of the following reference junctions:

- RJ-INT
- RJ-MAN
- RJ-AUT
- 4-20 mA
- 0-20 mA

Key: ENT If RJ-INT or RJ-EXT is selected, a return is effected to the measurement or transmission mode. If RJ-MAN is selected, the menu for entering the reference-junction temperature is called up. If 4-20mA is selected, the menu for entering the temperatures at 4 mA & 20 mA is called up. If 0-20mA is selected, the menu for entering the temperatures at 0 mA & 20 mA is called up.

Pressing the \blacktriangledown key calls up the menu for setting the TC type.

Pressing the \blacktriangle key calls up the menu for setting the reference junction (RJ) for TC transmission.

4.17.3 Entering the reference junction temperature

This menu is obtained by pressing the ENT key in the RJ menus if TC+ RJ-MAN for transmission or RJ-MAN for measurement was selected.

The following display appears on the LCD:

	S	E	T	T	I	N	G		R	J	-	M	A	N					
	R	J	:		1	2	3	.	4			°	C						

The currently set reference-junction temperature is displayed in the 2nd row.

Using the $0-9$ number keys, the P decimal-point key and the \pm sign key, a new temperature value can be entered.

Complete your entry with the TC or UNIT key. This entry applies to the selected TC type.

A current entry can be cancelled with the C key.

Pressing the ENT key effects a return to the transmission or measurement menu.

4.17.4 Entering temperatures with RJ = 4-20 mA

This menu is obtained by pressing the **ENT** key in the RJ menus if TC+ 4-20 mA for transmission or 4-20 mA for measurement was selected.

The following display appears on the LCD:

>	0			m	A	:			2	3	.	5		°	C					
	2	0		m	A	:			1	3	4	.	8		°	C				

Temperatures related to 4 mA or 20 mA can be entered in this menu.

Use the **▲** and **▼** keys to change between the two parameters. The selected parameter is marked with a **>** cursor symbol.

Using the **0**–**9** number keys, the **P** decimal-point key and the **±** sign key, a new temperature value can be entered.

Complete your entry with the **TC** or **UNIT** key.
This entry applies to the selected TC type.

A current entry can be cancelled with the **C** key.

Pressing the **ENT** key effects a return to the transmission or measurement menu.

4.17.5 Entering temperatures with RJ = 0-20 mA

This menu is obtained by pressing the **ENT** key in the RJ menus if TC+ 0-20mA for transmission or 0-20 mA for measurement was selected.

The following display appears on the LCD:

>	0			m	A	:			2	8	.	3		°	C					
	2	0		m	A	:			2	8	4	.	3		°	C				

Temperatures related to 0 mA or 20 mA can be entered in this menu.

Use the **▲** and **▼** keys to change between the two parameters. The selected parameter is marked with a **>** cursor symbol.

Using the **0**–**9** number keys, the **P** decimal-point key and the **±** sign key, a new temperature value can be entered.

Complete your entry with the **TC** or **UNIT** key.
This entry applies to the selected TC type.

A current entry can be cancelled with the **C** key.

Pressing the **ENT** key effects a return to the transmission or measurement menu.

4.17.6 Selecting units for TC and RTD

This menu is obtained by pressing the **FCT** and **UNIT** keys.
 The following display appears on the LCD:

>	T	C	:							°	C						
	R	T	D	:						Ω							

Row 1: Unit for TC
 Row 2: Unit for Rtd

The units for TC and Rtd are set in this menu. These units are applicable to the measurement and transmission modes.

The **UNIT** key is assigned the selected units.
 These units are also applicable to the entry of parameters in the function menu.

Use the **▲** and **▼** cursor keys to toggle between the two parameters.

The selected parameter is marked by the **>** cursor symbol.

Setting the TC unit:

The TC unit can be toggled with the **→** and **←** keys between the following options:
 K
 °C
 °F

Setting the RTD unit:

The RTD unit can be toggled with the **→** and **←** keys between the following options:
 K
 °C
 °F
 Ω

Pressing the **ENT** key saves the newly selected units and effects a return to the measurement or transmission mode.

4.18 Range selection and zero offset with U transmission

This menu is obtained by pressing FCT and mV or V .
The following display appears on the LCD:

>	U	:	M	A	N			1	0	.	0	0				V			
	Z	E	R	O				O	F	F	S	E	T						0

In this menu, manual or automatic range selection can be set for voltage transmission, and zero offset can be performed.

Use the \blacktriangle and \blacktriangledown cursor keys to toggle between the two parameters.

The selected parameter is marked by the > cursor symbol.

Setting range selection:

Use the \leftarrow and \rightarrow cursor keys to toggle between the following options:

U:AUTO (automatic range selection)

U:MAN "voltage value" (manual range selection)

On the selection of U:MAN, the maximum value is also displayed.

If manual range selection has been set, the 0 – 9 number keys and the P key can be used to enter a new value.

This value is considered absolute, i.e. the entry of a sign is not possible.

Complete your entry with the mV or V key.

On the basis of the entered value, the device selects the corresponding transmission range to ensure the validity of this value at all events, provided that it lies within the absolute transmission limits.

Permissible range for entered values: $0 \text{ V} < \text{VALUE} \leq 11.0 \text{ V}$

A current entry can be cancelled with the C key.

The previous value is displayed again.

Performing zero offset:

Press the 1/0 key to commence zero offset. While the offset is in progress, a "1" is indicated instead of a "0" in the last column of the display.

0 V is output during zero offset. The output voltage is recorded internally by the measurement section. The transmission section is balanced in accordance with the measured zero error.

Pressing the ENT key effects a return to the transmission or measurement menu.

If manual range selection has been set, it is indicated in the transmission mode by an "M:" in the 1st row of the LCD.

4.19 Range selection with RTD transmission

This menu is obtained by pressing **FCT** and **4**.
 The following display appears on the LCD:

			R	A	N	G	E		S	E	L	E	C	T	I	O	N		
R	T	D	:	M	A	N		1	4	5	.	2	3			°	C		

In this menu, manual or automatic range selection can be set for Rtd transmission.
 The current setting is displayed in the 2nd row of the LCD.

Use the **←** and **→** keys to toggle between the following options:

- RTD:AUTO(automatic range selection)
- RTD:MAN "value" (manual range selection)

On the selection of RTD: MAN, the maximum value is also displayed.

If manual range selection has been set, the **0**–**9** number keys and the **P** key can be used to enter a new value.

This value is considered absolute, i.e. the entry of a sign is not possible.

Complete your entry with the **RTD** or **UNIT** key.

On the basis of the entered value, the device selects the corresponding transmission range to ensure the validity of this value at all events, provided that it lies within the absolute transmission limits.

A current entry can be cancelled with the **C** key.
 The previous value is displayed again.

Pressing the **ENT** key effects a return to the transmission or measurement menu.

If manual range selection has been set, it is indicated in the transmission mode by an "M:" in the 1st row of the LCD.

4.20 Storage and retrieval of device setting

This menu is obtained by pressing **FCT** and **5**.

The following display appears on the LCD:

>	S	T	O	R	E	:	2												
	L	O	A	D	:					4									

This menu is meant for **STORING** and **LOADING** device settings.

▲ and **▼** keys: Use these keys to change over between row 1 (**STORE**) and row 2 (**LOAD**).

The selected row is marked by a **>** cursor symbol.

ENT key: This key effects a return to the measurement or transmission mode without a function having been activated.

A new entry can be made for the selected parameter.

STORE selection:

Use the **←** and **→** keys to toggle the memory number between values of 1 to 4.

Press the **FCT** key to store the device setting under the selected number.

LOAD selection:

Use the **←** and **→** keys to toggle the memory number between values of 1 to 4 and the **DEFAULT** value.

Pressing the **FCT** key retrieves the device setting stored under the selected **0**-**9** number.

On the selection of **DEFAULT**, the device is configured with factory settings.

4.21 LCD contrast setting

This menu is obtained by pressing **FCT** and **6**.

The following display appears on the LCD:

C	O	N	T	R	A	S	T		S	E	T	T	I	N	G				
>					5														

The contrast can be adjusted with the **0**–**9** number keys between a value of 0 (minimum contrast) and 9 (maximum contrast).

The selected value is displayed in the 2nd row of the LCD.

ENT key:

This key effects a return to the measurement or transmission mode.

4.22 Range selection with I transmission

This menu is obtained by pressing **FCT** and **mA**.

The following display appears on the LCD:

			R	A	N	G	E		S	E	L	E	C	T	I	O	N		
I	:	M	A	N						1	4	.	2	3				m	A

In this menu, manual or automatic range selection can be set for current transmission.

The present setting is displayed in the 2nd row of the LCD.

Use the **←** and **→** keys to toggle between the following options:

I:AUTO (automatic range selection)

I:MAN "current value" (manual range selection)

On the selection of I:MAN, the maximum value is also displayed.

If manual range selection has been set, the **0**–**9** number keys and the **P** key can be used to enter a new value.

This value is considered absolute, i.e. the entry of a sign is not possible.

Complete your entry with the **mA** key.

On the basis of the entered value, the device selects the corresponding transmission range to ensure the validity of this value at all events, provided that it lies within the absolute transmission limits.

Permissible range of entered values:

0 V ≤ VALUE ≤ 22.0 mA

A current entry can be cancelled with the **C** key.

The previous value is displayed again.

Pressing the **ENT** key effects a return to the transmission or measurement menu.

If manual range selection has been set, it is indicated in the transmission mode by an "M:" in the 1st row of the LCD.

4.23 Setting the ground connection

This menu is obtained by pressing **FCT** and **7**.
 The following display appears on the LCD:

		G	R	O	U	N	D		C	O	N	N	E	C	T	I	O	N		
M	E	A	S	S	E	C	T	I	O	N		I	N	T	E	R	N	A	L	

In this menu, the ground connection of the measurement section can be set.

Use the **←** and **→** keys to select one of the following options for the ground connection: INTERN, EXTERN, AUTO

On the INTERN setting, the measurement section is internally grounded in the measurement mode.

On the EXTERN setting, the measurement section must be externally grounded in the measurement mode.

On the AUTO setting, the measurement section is internally grounded only in the measurement mode; in the simultaneous measurement and transmission mode, the measurement section must be externally grounded.

Note: Measuring an externally generated voltage without reference to the potential DIGISTANT® model 4420-V001 is not permitted.
 When used as an internal source is a potential reference given by the transmission of voltage or current.
 When connecting an external source the reference potential must always be done "manually". This can be done either through a connection to the source minus connection or by setting potential binding "INTERN". "AUTO" is a special case, pure measure means "INTERN". In transmission and measuring the setting "AUTO" means binding potential "EXTERN"!

Pressing the **ENT** key effects a return to the transmission or measurement menu.

4.24 Displaying the data and time

This menu is obtained by pressing **FCT** and **9**.
 The following display appears on the LCD:

	D	A	T	E	:					1	4	.	1	0	.	1	3		
	T	I	M	E	:			1	5	:	2	3	:	4	6				

The date and time are displayed on the LCD.

Pressing the **ENT** key effects a return to the transmission or measurement menu.

4.25 Setting the data and time

This menu is obtained by pressing **FCT** and **8**.
The following display appears on the LCD:

>	D	A	T	E	:					1	4	.	1	0	.	9	4	
	T	I	M	E	:			1	5	:	2	3	:	4	6			

The date and time can be reset here.

▲ and **▼** keys: Use these keys to change over between row 1 (DATE) and row 2 (TIME). The selected row is marked with a **>** cursor symbol. A new entry can be made for the selected parameter.

Setting the DATE:

Use the **←** and **→** keys to select a digit within the date display.

Use the **0**–**9** number keys to reset the date digit.

Setting the TIME:

Use the **←** and **→** keys to select a digit within the time display.

Use the **0**–**9** number keys to reset the time digit.

Pressing the **ENT** key saves the set date and time, and effects a return to the transmission or measurement menu.

5. Remote operation of the device

5.1. Control via the serial interface

Introduction

The device can be controlled via an RS232 serial interface. The interface type is selected in the interface menu. The ANSI-standard protocol for communications between the system controller and the 4420-V001 is:

ANSI X3.28-1976 Subcategory 2.5, A3/A4

Settings in the se- rial interface menu

Hardware settings

The hardware settings of the 4420-V001 and the system controller must be identical to allow proper communication.

Baud rate

The baud rate is adjustable in steps from 300 ... 19200 bits/sec.

Data bits

7 or 8

Stop bits

1 or 2

Parity

Even, odd or none

Software settings

Group address

The group address at which the 4420-V001 can be actuated is:
0..15 (0..f)

User address

The user address at which the 4420-V001 can be actuated is:
0..15 (0..f)

Character delay

Activation of a time delay (approx. 1-1.5 ms) between two transmitted bytes.

Block check

If block check = ON, transmission is carried out in accordance with the ANSI standard X3.28 Subcat.2.5,A4. The BCC is sent after <ETX> . It is formed from all bytes which follow <STX>, including <ETX>. The BCC is an "Exclusive-Or" combination of these bytes.

Explanation of the communications protocol for establishing

General description

The ANSI standard X3.28 Subc.2.5. is used in systems where several sub-stations are present in a non-switched, multi-point connection and all instructions are sent from a control station. Only one transmitter (master) and one receiver (slave) are active on the bus at any time.

One of the stations is the control station. It is assigned master status and sends instructions to a selected slave station, or transfers its master status to a sub-station and assumes slave status in order to receive data. A link between two sub-stations is not permissible. The control station monitors links constantly.

Link establishment

Before a link is established, the control station has master status and none of the sub-stations has slave status. The control station can either

- (1) Poll in order to transfer master status to a sub-station
- or
- (2) Specify a slave station for establishing a link.

DIGISTANT as master **Polling**

The control station sends a "Polling Supervisory Sequence". This sequence is meant to fetch data requested from the 4420-V001. The prefix selects a single station. <ENQ> defines the end of the polling supervisory sequence.

The polling supervisory sequence of the 4420-V001 has the following format:

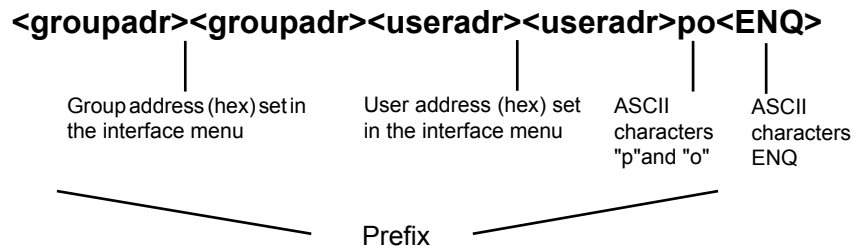

Example:

Selected group address: 10
 Selected user address: 11

 Polling supervisory sequence: aabbpo<ENQ>

A sub-station which recognizes its polling supervisory sequence responds in one of two possible ways:

- (1) If the station has data to send, it commences data transmission. The control station assumes slave status.
- (2) If the station has no data to send, it outputs <EOT> which terminates its master status, transferring it back to the control station.

If the control station receives no response or an invalid one, it terminates the link by sending <EOT>.

DIGISTANT as slave **Selection with response**

The control station sends a "Selection Supervisory Sequence". This sequence is meant to initialise the 4420-V001 as a slave so that it can receive SCPI instructions. The prefix selects a single sub-station. <ENQ> defines the end of the selection supervisory sequence.

The selection supervisory sequence of the 4420-V001 has the following format:

<groupadr><groupadr><useradr><useradr>sr<ENQ>

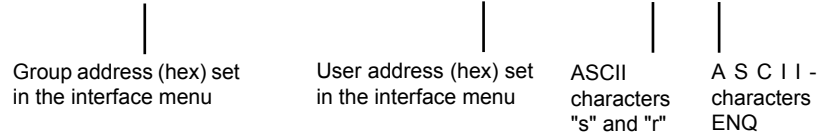

Example:

Selected group address: 5
Selected user address: 6

Selection supervisory sequence: 5566sr<ENQ>

A sub-station which recognizes its selection supervisory sequence assumes slave status and responds in one of two possible ways:

- (1) If the station is ready to receive data, it sends <ACK>. On receiving this response, the master station commences data transmission.

- (2) If the station is not ready to receive data, it sends <NAK>. On receiving this response, the master station can attempt to call the same station again.

If the master station receives no response or an invalid one, it can attempt to address the same station once again or terminate the transmission.

Fast selection

Instead of "selection with response", the master station can send a selection supervisory sequence without <ENQ>. This selects a sub-station as the slave station. The master station commences data transmission directly without waiting for an acknowledgement from the sub-station.

Example:

Selected group address: 5
Selected user address: 6

Fast selection sequence: 5566sr<STX>SCPI instruction <ETX>

Link termination

Termination

The master station sends <EOT> to indicate that it does not have any more data to transmit. <EOT> transfers master status back to the control station.

Explanation of the data transmission protocol in accordance with ANSI X3.28 Subcat A3/A4

After link establishment in accordance with the ANSI X3.28 Subcat 2.5 protocol, the data is transmitted in accordance with Subcat. A3 or Subcat. A4 (corresponding to A3 with an additional block-check character).

Subcat. A3/A4 is used in systems where a master station sends data to a single slave. The master station sends every message to the slave station and waits for a response. If the response indicates that the data was accepted (ACK), the master station can send another message or terminate the link. A negative response (NAK) from the slave station indicates to the master station that the data was not understood.

Data transmission

Data transmission is commenced by the master station after link establishment (see Subcat 2.5). The master station starts transmission with <STX>. The required data is sent subsequently. The data block ends with <ETX>. During transmission in accordance with Subcat. A4, <ETX> must be followed by the block-check character (BCC).

Response

After recognizing <ETX> or <BCC>, the slave station sends one of two possible responses:

- (1) If the data was accepted and the station is ready to receive new data, it sends <ACK>. After that, the master station can either send the next batch of data or end the transmission.
- (2) If the data was not accepted and the slave station is ready to receive new data, it sends <NAK>. After that, the master station can send other data or terminate the link.

If the master station receives no response or an invalid one, it can send a "Reply-Request Supervisory Sequence" consisting of <ENQ> or terminate the link.

Timer functions in accordance with ANSI X3.28

The timers defined in the ANSI standard are used for indicating that a particular control character was not received within a specified time interval.

Timer A (response timer)

Timer A is used by the transmitting station as protection against no response or an invalid one.

Start: Timer A is started after the transmission of any endcharacter which generates a response expectancy (e.g. ENQ or ETX).

Stop: Timer A is stopped once a valid response has been received.

Timeout: When a timeout occurs, the 4420-V001 sends EOT to terminate the link.

Timer A in the 4420-V001 is set to a value of 5 seconds.

Timer B (receive timer)

Timer B is used by the receiving station as protection against failures to recognize end-of-text characters (e.g. ETX).

Start: Timer B is started on the reception of a start-of-text character (STX).

Restart: Timer B is restarted as long as data is being received, to allow the reception of data blocks of varying lengths.

Stop: Timer B is stopped on the reception of a valid endcharacter.

Timeout: When a Timeout occurs, the received data is rejected and the 4420-V001 waits for the next transmission.

Timer B in the 4420-V001 is set to a value of 5 seconds.

Flow chart of link establishment in accordance with ANSI X3.28 Sub2.5, A3/A4

The following diagram shows the establishment of a link between a system controller and the 4420-V001. The 4420-V001 has a group address of 0 and a user address of 0.

		Master	Slave
1.	The controller sends a selection supervisory sequence 0000sr<ENQ>	Controller	X
2.	4420-V001 assumes slave status and sends <ACK>	Controller	4 4 2 0 V001
3.	After that, the controller sends an instruction beginning with <STX> and ending with <ETX> or <BCC> <STX>:DISP:CONT?0.5<LF><ETX> (<BCC>)		
4.	On recognizing the instruction, the 4420-V001 sends <ACK> and writes the current setting of the display contrast into the output buffer.		
5.	The controller terminates the link with <EOT>	Controller	X
6.	To fetch the response of the 4420-V001, the controller sends the polling supervisory sequence, which transfers master status to the 4420-V001. 0000po<ENQ>	4420-V001	Controller
7.	The 4420-V001 transfers the data to its output buffer <STX>0.5<CR><LF><ETX> (<BCC>)		
8.	The controller responds with <ACK>		
9.	The 4420-V001 sends <EOT> to terminate the link.	Controller	X

A personal computer with an RS232 interface can be used as the system controller. The appendix contains a sample program in GW-Basic for controlling the 4420-V001 via the serial interface of a PC.

5.2. SCPI Instruction list for the DIGISTANT® model 4420-V001

5.2.1 SCPI Version

SCPI version: 1993.0

The SCPI version can be requested with the instruction `SYSTem:VERSion?` .

5.2.2 Measurement Instructions

CONFigure: CURREnt

DESCRIPTION: The device is switched to current measurement if it is in the measurement mode or simultaneous transmission and measurement mode.

SYNTAX: CONFigure:CURREnt
Parameters: No parameters

REMARKS:
Enquiry form: No enquiry form

Restrictions: Instruction not permissible if
 - device in ramp mode,
 - device in calibration mode,
 - measurement in progress.

CONFigure:VOLTage

DESCRIPTION: The device is switched to voltage measurement if it is in the measurement mode or simultaneous transmission and measurement mode.

SYNTAX: CONFigure:VOLTage
Parameters: No parameters

REMARKS:
Enquiry form: No enquiry form

Restrictions: Instruction not permissible if
 - device in ramp mode,
 - device in calibration mode,
 - measurement in progress.

CONFigure:TEMPerature:FRTD

DESCRIPTION: If the device is in the measurement mode or simultaneous transmission and measurement mode, it is switched to RTD measurement and the RTD type is selected
 In the transmission mode, only the RTD type is selected.

SYNTAX: CONFigure:TEMPerature:FRTD <parameter>

Parameters:

Pt100	->	set RTD to Pt100.
Ni100	->	set RTD to Ni100.
Pt200	->	set RTD to PT200.
Pt500	->	set RTD to Pt500.
Pt1000	->	set RTD to Pt1000.

REMARKS:
Enquiry form: CONFigure:TEMPerature:FRTD?

Response of the device: Pt100 -> If Pt100 is set.
 Ni100 -> If Ni100 is set.
 Pt200 -> If Pt200 is set.
 Pt500 -> If Pt500 is set.
 Pt1000 -> If Pt1000 is set.

Restrictions: Instruction not permissible if - device in ramp mode,
 - device in calibration mode,
 - measurement in progress.

CONFigure:TEMPerature:TCouple

DESCRIPTION: If the device is in the measurement mode or simultaneous transmission and measurement mode, it is switched to TC and the TC type is selected.
 In the transmission mode, only the TC type is selected.

SYNTAX: CONFigure:TEMPerature:TC <parameter>
 Parameters: The parameter corresponds to the TC type
 (R, S, B, J, T, E, K, U, L, N, C, D, G2, M)

REMARKS: Enquiry form: CONFigure:TEMPerature:TC?
 The selected TC type is supplied as the response.
 (R, S, B, J, T, E, K, U, L, N, C, D, G2, M)

Restrictions: Instruction not permissible if - device in ramp mode,
 - device in calibration mode,
 - measurement in progress.

CONFigure:P

DESCRIPTION: The device is switched to measure P (pressure) if it is in the measuring mode or mode "simultaneous transmission and measurement".

SYNTAX: CONFigure:P
 Parameters: No parameter
 Enquiry form: No enquiry form

REMARKS: Restrictions: The command isn't allowed in the following cases:
 - a measurement is started
 - the device is in the adjustment mode
 - the device is in the ramp mode

Special features: If the device is in the mode measure P and it is switched via the corresponding INSTRUMENT command on transmission, in such a way, it goes to transmission voltage U.

It becomes switched to simultaneous transmission and measure, in such a way, it goes to transmission voltage U and measure pressure P.

CONFigure:	P_Current
DESCRIPTION:	The device is switched to simultaneous measure P (pressure) and measure I (voltage) if it in the measuring mode not with simultaneous transmission and measurement.
SYNTAX:	CONFigure:P_Current
Parameters:	No parameter
Enquiry form:	non enquiry form
REMARKS:	
Restrictions:	The command isn't allowed in the following cases: <ul style="list-style-type: none">- a measurement is started- the device is in the adjustment mode- the device is in the ramp mode- with simultaneous transmission and measurement
Special features:	If the device is in the simultaneous measure P and I is it changed via the corresponding INStrument command to transmission, in such a way, the device goes IF the device is in the simultaneous measure P and I and is it changed via corresponding INSTRument command to simultaneous transmission and measure switched such a way, it goes to transmission I and P.
CONFigure:P_Voltage	
DESCRIPTION:	The device is switched to simultaneous measure P (pressure) and measure U (voltage) if it in the measuring mode not with simultaneous transmission and measurement.
SYNTAX:	CONFigure:P_Voltage
Parameters:	No parameter
Enquiry form:	non enquiry form
REMARKS:	
Restrictions:	The command isn't allowed in the following cases: <ul style="list-style-type: none">- a measurement is started- the device is in the adjustment mode- the device is in the ramp mode- with simultaneous transmission and measurement
Special features:	If the device is in the simultaneous measure P and U and is it changed via the corresponding INStrument command to transmission, in such a way, the device goes If the device is in the simultaneous measure P and U and is it changed via corresponding INSTRument command to simultaneous transmission and measure switched such a way, it goes to transmission U and measure P.
FETCh?	
DESCRIPTION:	A measured value is request.
SYNTAX:	FETCh?
Parameters:	No parameter
REMARKS:	

Enquiry form: Only enquiry form
If a measured value is available, it is returned together with it's unit.

Restrictions: The command isn't allowed in the following cases:
- a measurement is started
- the device is in the adjustment mode
- the device is in the ramp mode
- with simultaneous transmission and measurement

FETCh:P?

DESCRIPTION: A measured pressure value can be picked-up.

SYNTAX: FETCh:P?

Parameters: No parameter

Enquiry form: Only enquiry form

Answer: Numeric value with unit

5.2.3 CALCulate Subsystem

CALCulate:LIMit:STATe

DESCRIPTION: The max./min. function for the measurement mode is activated/deactivated.

SYNTAX: CALCulate:LIMit:STATe <parameter>

Parameters: ON or 1 -> The max./ min. function is activated.
OFF or 0 -> The max./ min. function is deactivated.

REMARKS:

Enquiry form: CALCulate:LIMit:STATe?

Response by the device: 1 -> If the max./ min. function is active.
0 -> If the max./ min. function is inactive.

Restrictions: Instruction not permissible if - device in ramp mode,
- device in calibration mode.

CALCulate:LIMit:CLEar

DESCRIPTION: The max./ min. function for the measurement mode is reset.

SYNTAX: CALCulate:LIMit:STATe

Parameters: No parameters

REMARKS:

Enquiry form: No enquiry form

Restrictions: Instruction not permissible if - device in ramp mode,
- device in calibration mode.

5.2.4	CALibration Subsystem
-------	-----------------------

The instructions of this system are meant for calibrating the device.

CALibration:STAtE

DESCRIPTION: The calibration mode is activated or deactivated.

SYNTAX: CALibration:STAtE <parameter>
Parameters: 1 or ON -> The calibration mode is activated.
0 or OFF -> The calibration mode is deactivated.

REMARKS:
Enquiry form: CALibration:STAtE?

Response by the device: 1 -> If the calibration mode is active.
0 -> If the calibration mode is inactive.

Restrictions: Instruction not permissible if - device in ramp mode,
- measurement in progress,
- calibration in progress.

CALibration:VOLTage:LOW

DESCRIPTION:
Preliminary: This instruction is meant for calibrating the voltage transmitter and the voltage measurement section over a particular range. The measurement input must be connected with the transmission output. An external voltage-measurement device must also be connected with the transmission output. The measured voltage value must be noted or stored.

This instruction: A switchover is effected to the relevant transmission and measurement range. A defined LOW value is output to the D/A-converter of the transmission section. This value is also recorded by the internal measurement section.

SYNTAX: CALibration:VOLTage:LOW <parameter>
Parameters: This parameter is meant for specifying the transmission or measurement range.

10	MV	->	for	10	mV	range
100	MV	->	for	100	mV	range
1	V	->	for	1	V	range
11	MV	->	for	11	V	range

REMARKS:
Enquiry form: No enquiry form
Restrictions: Instruction not permissible if
- device in calibration mode,
- a LOW or HIGH value in a different range has already been output before calibration of this range was completed.

CALibration:VOLTagE:HIGH

DESCRIPTION:

Preliminary:

This instruction is meant for calibrating the voltage transmitter and the voltage measurement section over a particular range. The measurement input must be connected with the transmission output. An external voltage-measurement device must also be connected with the voltage transmission output. The measured voltage value must be noted or stored.

This instruction:

A switch over is effected to the relevant transmission and measurement range. A defined HIGH value is output to the D/A-converter of the transmission section. This value is also recorded by the internal measurement section.

SYNTAX:

Parameters:

CALibration:VOLTagE:HIGH <parameter>

This parameter is meant for specifying the transmission or measurement range.

10	MV	->	for	10	mV	range
100	MV	->	for	100	mV	range
1	V	->	for	1	V	range
11	MV	->	for	11	V	range

REMARKS:

Enquiry form:

No enquiry form

Restrictions:

Instruction not permissible if

- device in calibration mode,
- measurement in progress,
- calibration in progress,
- a LOW or HIGH value in a different range has already been output before calibration of this range was completed.

CALibration:VOLTagE

DESCRIPTION:

Preliminary:

This instruction is meant for calibrating the voltage transmitter and the voltage measurement section over a particular range. The LOW and HIGH values in this range must already have been output. The two externally measured voltage values must be available. Using these values, the relevant transmission and measurement range is calibrated.

This instruction:

A switch over is effected to the relevant transmission and measurement range. A defined HIGH value is output to the D/A-converter of the transmission section. This value is also recorded by the internal measurement section.

SYNTAX:

CALibration:VOLTagE <parameter>

Parameters:

Measured LOW value, measured HIGH value

Measured LOW value:

The value measured externally during transmission of the LOW value for this range.

Measured HIGH value:

The value measured externally during transmission of the HIGH value for this range.

REMARKS:

Enquiry form:

No enquiry form

Restrictions:

This instruction is only permissible in the calibration mode.

A LOW and HIGH value in this range must already have been output.

CALibration:VOLTage:DATA?

DESCRIPTION: The calibration values from the voltage transmission and voltage measurement section are fetched.

SYNTAX: CALibration:VOLTage:DATA? <parameter>
Parameters: IN -> The calibration values of the voltage measurement section are supplied.
 OUT -> The calibration values of the voltage transmission section are supplied.

REMARKS:
Enquiry form: Only enquiry form

Response:

Measurement section:

Slope	[10 mV],	Offset	[Channel1]	[10 mV],
Offset [Channel 2]	[-10 mV],	Offset	[Channel3]	[10 mV],
Slope	[100 mV],	Offset	[Channel1]	[100 mV],
Offset [Channel 2]	[-100 mV],	Offset	[Channel3]	[100 mV],
Slope	[1 V],	Offset	[Channel1]	[1 V],
Offset [Channel 2]	[-1 V],	Offset	[Channel3]	[1 V],
Slope	[11 V],	Offset	[Channel1]	[11 V],
Offset [Channel 2]	[-11 V],	Offset	[Channel3]	[11 V].

Transmission section:

Slope	[10 mV]	Offset	[10 mV],
Slope	[-10 mV],	Offset	[-10 mV],
Slope	[100 mV],	Offset	[100 mV],
Slope	[-100 mV],	Offset	[-100 mV],
Slope	[1 V],	Offset	[1 V],
Slope	[-1 V],	Offset	[-1 V],
Slope	[11 V],	Offset	[11 V],
Slope	[-11 V],	Offset	[-11 V].

Restrictions: This instruction is only permissible in the calibration mode.
 It is not permissible if a calibration measurement is in progress.

CALibration:CURREnt:LOW

DESCRIPTION:
Consideration: The command is used to calibrate the current source and current measurement of certain range. The measuring input must be connected with the source output.
 An external current measuring device must connected additional to the source output. The measured current value must be noted and/or stored.

This command: It is switched into the adequate and measurement range. At the D/A converters from the source is simulated a defined LOW value. In addition, the value of internal measurement is recorded.

SYNTAX: CALibration:CURREnt:LOW <parameter>

Parameters: This parameter is meant for specifying the transmission or measurement range.

2 mA ->	for	2 mA range
22 mA ->	for	22 mA range
- 2 mA ->	for	- 2 mA range
- 22 mA ->	for	- 22 mA range

REMARKS:
Enquiry form: No enquiry form

Restrictions: Instruction only permissible in the calibration mode.
 Instruction is not permissible if

- a calibration measurement is in progress,
- a LOW or HIGH value in a different range has already been output before calibration of this range was complete

CALibration:CURRent:HIGH

DESCRIPTION:
Preliminary: This instruction is meant for calibrating the voltage transmitter and the voltage measurement section over a particular range. The measurement input must be connected with the transmission output. An external current-measurement device must also be connected with the transmission output. The measured current value must be noted or stored.

This instruction: A switchover is effected to the relevant transmission and measurement range. A defined LOW value is output to the D/A-converter of the transmission section. This value is also recorded by the internal measurement section.

SYNTAX: CALibration:CURRent:HIGH <parameter>

Parameters: This parameter is meant for specifying the transmission or measurement range.

2 mA	->	for	2 mA	range
22 mA	->	for	22 mA	range
- 2 mA	->	for	- 2 mA	range
- 22 mA	->	for	- 22 mA	range

REMARKS:
Enquiry form: No enquiry form

Restrictions: Instruction only permissible in the calibration mode.

Instruction is not permissible if

- a calibration measurement is in progress,
- a LOW or HIGH value in a different range has already been output before calibration of this range was completed.

CALibration:CURRent

DESCRIPTION:
Preliminary: This instruction is meant for calibrating the voltage transmitter and the voltage measurement section over a particular range. The LOW and HIGH values in this range must already have been output. The two externally measured voltage values must be available. Using these values, the relevant transmission range is calibrated. If the 22 mA or -22 mA range has been selected, then the measurement section is also calibrated.

SYNTAX: CALibration:CURRent <parameter>

Parameters: Measured LOW value, measured HIGH value

Measured LOW value: **The value measured externally during transmission of the LOW value for this range.**

Measured HIGH value: The value measured externally during transmission of the HIGH value for this range.

REMARKS:
Enquiry form: No enquiry form

Restrictions: This instruction is only permissible in the calibration mode.

This instruction is not permissible if a calibration measurement is in progress.

A LOW and HIGH value in this range must already have been output.

CALibration:CURRent:DATA?

DESCRIPTION: The calibration values from the current transmission and current measurement section are fetched.

SYNTAX: CALibration:CURRent:DATA? <parameter>

Parameters: IN -> The calibration values of the current measurement section are supplied.
OUT -> The calibration values of the current transmission section are supplied.

REMARKS:
Enquiry form: Only enquiry form

Response: Meas. section: Slope, Offset

Transmission section:

Slope	[2 mA],	Offset	[2 mA],
Slope	[-2 mA],	Offset	[-2 mA],
Slope	[22 mA],	Offset	[22 mA],
Slope	[-22 mA],	Offset	[-22 mA].

Restrictions: This instruction is only permissible in the calibration mode.

This instruction is not permissible if a calibration measurement is in progress.

CALibration:RREF:LOW

DESCRIPTION:
Preliminary: This instruction is meant to calibrate the 180 Ω reference resistor. A known resistor in the range of 180 Ω is connected externally for this purpose. Calibration is performed by measuring the voltage drop across the external resistor and the internal reference resistor.

SYNTAX: CALibration:RREF:LOW <parameter>

Parameters: The value of the externally connected resistor. Numerical value, with optional unit.

Permissible units: M OHM, OHM, K OHM, MA OHM.
Default unit: OHM

REMARKS:
Enquiry form: No enquiry form

Restrictions: This instruction is only permissible in the calibration mode.

It is not permissible if

- a calibration measurement is in progress,
- a previous calibration has not been completed.

CALibration:RREF:HIGH

DESCRIPTION:
 Preliminary: This instruction is meant to calibrate the 1.98 kΩ reference resistor. A known resistor in the range of 1.9-2 kΩ is connected externally for this purpose. Calibration is performed by measuring the voltage drop across the external resistor and the internal reference resistor.

SYNTAX: CALibration:RREF:HIGH <parameter>

Parameters: The value of the externally connected resistor. Numerical value, with optional unit.
 Permissible units: M OHM, OHM, K OHM, MA OHM
 Default unit: OHM

REMARKS:
 Enquiry form: No enquiry form

Restrictions: This instruction is only permissible in the calibration mode.
 It is not permissible if - a calibration measurement is in progress,
 - a previous calibration has not been completed

CALibration:RREF:DATA?

DESCRIPTION: The calibration values of the two internal reference resistors are supplied.

SYNTAX: CALibration:RREF:DATA? <parameter>

Parameters: No parameters

REMARKS:
 Enquiry form: Only enquiry form

Response: Rref[180Ω], Rref[360Ω]

Restrictions: This instruction is only permissible in the calibration mode.
 This instruction is not permissible if a calibration measurement is in progress.

CALibration:PT100

DESCRIPTION: The correction factor of the internal Pt100 is determined here. A precisely known Pt100 sensor is connected externally by plugging it into the "-" input socket. After a sufficiently long period of temperature compensation, this instruction can be sent. The device measures the temperature with the internal and external Pt100. The correction factor of the internal PT100 can then be determined on the basis of these two measured values.

SYNTAX: CALibration:PT100

Parameters: No parameters

REMARKS:
 Enquiry form: No enquiry form

Restrictions: This instruction is only permissible in the calibration mode.
 It is not permissible if - a calibration measurement is in progress,
 - a previous calibration has not been completed.

CALibration:PT100:DATA?

DESCRIPTION:	The correction factor of the internal Pt100 can be requested here.
SYNTAX:	CALibration:PT100:DATA?
Parameters:	No parameters
REMARKS: Enquiry form:	Only enquiry form
Response:	The correction factor of the internal Pt100.
Restrictions:	This instruction is only permissible in the calibration mode. This instruction is not permissible if a calibration measurement is in progress.

CALibration:RTD:LOW

DESCRIPTION:	This instruction is meant to calibrate the RTD simulator. A defined LOW value in a particular current and resistance range is output to the D/A converter. The value must be measured externally. This measurement value must be noted or stored.
SYNTAX:	CALibration:RTD:LOW <parameter>
Parameters:	Current, resistance Current values: ILOW -> low current rang HIGH -> high current range Resistance values: 200OHM -> 200 Ω range 2KOHM -> 2 kΩ range
REMARKS:	
Enquiry form:	No enquiry form
Restrictions:	This instruction is only permissible in the calibration mode. This instruction is not permissible if a calibration measurement is in progress.

CALibration:RTD:HIG

DESCRIPTION:	This instruction is meant to calibrate the RTD simulator. A defined HIGH value in a particular current and resistance range is output to the D/A converter. The value must be measured externally. This measurement value must be noted or stored.
SYNTAX:	CALibration:RTD:HIG <parameter>
Parameters:	Current, resistance Current values: ILOW -> low current range HIGH -> high current range Resistance values: 200OHM -> 200 Ω range 2KOHM -> 2 kΩ range
REMARKS:	
Enquiry form:	No enquiry form
Restrictions:	This instruction is only permissible in the calibration mode. This instruction is not permissible if a calibration measurement is in progress.

CALibration:RTD

DESCRIPTION:
Preliminary: This instruction is meant to calibrate the RTD simulator over a particular current and resistance range. The LOW and HIGH values in this range must already have been output. The two corresponding measurement values are transferred as part of the parameter and used as a basis for determining the calibration values.

SYNTAX: CALibration:RTD <parameter>

Parameters: low_meas, high_meas
low_meas: measurement value for output of the LOW value.
high_meas: measurement value for output of the HIGH value.

REMARKS:
Enquiry form: No enquiry form

Restrictions: This instruction is only permissible in the calibration mode.
This instruction is not permissible if a calibration measurement is in progress.
A LOW and HIGH value must already have been output.

CALibration:RTD:DATA?

DESCRIPTION: The calibration values for resistance simulation can be requested here.

SYNTAX: CALibration:RTD:DATA? <parameter>

Parameters: No parameters

REMARKS:
Enquiry form: Only enquiry form

Response:

Slope	[+]	[200Ω]	[500μA],	Offset	[+]	[200Ω]	[500μA],
Slope	[+]	[200Ω]	[5mA],	Offset	[+]	[200Ω]	[5mA],
Slope	[+]	[2kΩ]	[500μA],	Offset	[+]	[2kΩ]	[500μA],
Slope	[+]	[2kΩ]	[5mA],	Offset	[+]	[2kΩ]	[5mA],
Slope	[-]	[200Ω]	[500μA],	Offset	[-]	[200Ω]	[500μA],
Slope	[-]	[200Ω]	[5mA],	Offset	[-]	[200Ω]	[5mA],
Slope	[-]	[2kΩ]	[500μA],	Offset	[-]	[2kΩ]	[500μA],
Slope	[-]	[2kΩ]	[5mA],	Offset	[-]	[2kΩ]	[5mA],

Restrictions: This instruction is only permissible in the calibration mode.
This instruction is not permissible if a calibration measurement is in progress.

5.2.5 DATallogger Subsystem

DATallogger:MODE

DESCRIPTION The data logger mode is activated or deactivated.

SYNTAX: DATallogger:MODE<parameter>

Parameters: ON or 1 -> Data logger mode on.
OFF or 0 -> Data logger mode off.

REMARKS:
Enquiry form: DATallogger:MODE?

CONFigure: CURRent

DESCRIPTION:	The device is switched to current measurement if it is in the measurement mode or the simultaneous transmission and measurement mode.		
SYNTAX:	CONFigure:CURRent		
Parameters:	No parameters		
REMARKS: Enquiry form:	No enquiry form		
Restrictions:	Instruction not permissible if - device in ramp mode, - device in calibration mode, - measurement in progress.		
Response:	1	->	Data logger mode on.
	0	->	Data logger mode off.
Restrictions:	Instruction not permissible if - device in ramp mode, - device in calibration mode, - device not in measurement mode on commencement of measurement and device not in data logger mode.		

DATallogger:START

DESCRIPTION:	Automatic data recording is commenced.		
SYNTAX:	DATallogger:START		
Parameters:	No parameters		
REMARKS: Enquiry form:	No enquiry form		
Restrictions:	Instruction not permissible if - device in ramp mode, - device in calibration mode, - device not in data logger mode.		

DATallogger:STOP

DESCRIPTION:	Automatic data recording is stopped.		
SYNTAX:	DATallogger:STOP		
Parameters:	No parameters		
REMARKS: Enquiry form:	No enquiry form		
Restrictions:	Instruction not permissible if - device in ramp mode, - device in calibration mode, - device not in data logger mode.		

DATallogger:STEP

DESCRIPTION:	A single measurement value is recorded.		
SYNTAX:	DATallogger:STEP		
Parameters:	No parameters		

REMARKS:
 Enquiry form: No enquiry form

Restrictions: Instruction not permissible if

- device in ramp mode,
- device in calibration mode,
- device not in data logger mode.

DATallogger:CLEar:LASTval

DESCRIPTION: The measurement value recorded last is cleared.

SYNTAX: DATallogger:CLEar

Parameters: No parameters

REMARKS:
 Enquiry form: No enquiry form

Restrictions: Instruction not permissible if

- device in ramp mode,
- device in calibration mode,
- automatic data recording in progress,
- device not in data logger mode.

DATallogger:CLEar:ALL

DESCRIPTION: The data logger's memory is cleared completely.

SYNTAX: DATallogger:CLEar.ALL

Parameters: No parameters

REMARKS:
 Enquiry form: No enquiry form

Restrictions: Instruction not permissible if

- device in ramp mode,
- device in calibration mode,
- automatic data recording in progress,
- device not in data logger mode.

DATallogger:CLEar:BLOCK

DESCRIPTION: A data block in the data logger's memory is cleared.

SYNTAX: DATallogger:CLEar.BLOCK

Parameters: Numerical value, interpreted as the block.

REMARKS:
 Enquiry form: No enquiry form

Restrictions: Instruction not permissible if

- device in ramp mode,
- device in calibration mode,
- automatic data recording in progress,
- device not in data logger mode.

DATallogger:TIME

DESCRIPTION: The storage time is set.

SYNTAX: DATallogger:TIME<parameter>

Parameters: Numerical value between 0 and 9999. This value is interpreted as the storage time in seconds.

REMARKS:
Enquiry form: DATalogger:TIME

Response: The currently set storage time in seconds.

Restrictions: Instruction not permissible if

- device in ramp mode,
- device in calibration mode,
- measurement in progress.

DATalogger:BLOCK:MINimum?

DESCRIPTION: The minimum value of a stored data block is calculated and supplied.

SYNTAX: DATalogger:BLOCK:MINimum?<parameter>

Parameters: The block number as a numerical value.

REMARKS:
Enquiry form: Only enquiry form

Response: The calculated minimum value of the block. Numerical value with unit.

Restrictions: Instruction not permissible if

- device in ramp mode,
- device in calibration mode,
- measurement in progress.

DATalogger:BLOCK:MAXimum?

DESCRIPTION: The maximum value of a stored data block is calculated and supplied.

SYNTAX: DATalogger:BLOCK:MAXimum?<parameter>

Parameters: The block number as a numerical value.

REMARKS:
Enquiry form: Only enquiry form

Response: The calculated maximum value of the block. Numerical value with unit.

Restrictions: Instruction not permissible if

- device in ramp mode,
- device in calibration mode,
- measurement in progress.

DATalogger:DATA:VALue?

DESCRIPTION: A value stored in the data logger is supplied.

SYNTAX: DATalogger:DATA:VALue?<parameter>

Parameters: The memory number as a numerical value.

REMARKS:
Enquiry form: Only enquiry form

Response: Memory number, block number, date, time, measurement value

Restrictions: Instruction not permissible if

- device in ramp mode,
- device in calibration mode,
- measurement in progress.

5.2.6 DISPlay Subsystem

DISPlay:BACKlight

DESCRIPTION: The LED background lighting for the CD is activated or deactivated.

SYNTAX: DISPlay:BACKlight <parameter>

Parameters: ON or 1 -> The background lighting is activated.
OFF or 0 -> The background lighting is deactivated.

REMARKS:
Enquiry form: DISPlay:BACKlight?

If the background lighting is on, a 1 is supplied, otherwise a 0 is supplied.

DISPlay:BACKlight:TIME

DESCRIPTION: The duration of the LED background lighting is set..

SYNTAX: DISPlay:BACKlight:TIME <parameter>

Parameters: The value of the duration can be set between 1 and 60 seconds.
The parameter only consists of the numerical value without the unit.

REMARKS:
Enquiry form: DISPlay:BACKligh:TIME?

The currently selected lighting time is supplied as the response.

DISPlay:CONTRast

DESCRIPTION: The contrast of the LCD display is set.

SYNTAX: DISPlay:CONTRast <parameter>

Parameters: The contrast can be set between 0 and 1.
0: minimum contrast; 1: maximum contrast

REMARKS:
Enquiry form: DISPlay:CONTRast?

The currently selected contrast value is supplied as the response.

5.2.7 INPut Subsystem

INPut:LOW

DESCRIPTION: The ground connection of the measurement section is selected.

SYNTAX: INPut:LOW <parameter>

Parameters: FLOat -> The measurement section must be floated.
GROund -> The measurement section must be internally grounded.
AUTO -> For simultaneous transmission and measurement, the measurement section must be grounded externally, otherwise internally.

REMARKS:
Enquiry form: INPut:LOW?

Response by the device: FLO -> If external grounding is set.
 GRO -> If internal grounding is set.
 AUTO -> If automatic grounding is set.

Restrictions: Instruction not permissible if - device in ramp mode,
 - device in calibration mode,
 - measurement in progress.

5.2.8	INSTrument Subsystem
-------	-----------------------------

INSTrument[:SElect]

DESCRIPTION: Changeover between the transmission and measurement modes.

SYNTAX: INSTrument [SElect] <parameter>

Parameters: 0 -> The device assumes the transmission mode.
 1 -> The device assumes the measurement mode.

REMARKS:
 Enquiry form: INSTrument [SElect]?

Response by the device: 0 -> If the device is in the transmission mode.
 1 -> If the device is in the measurement mode.

Restrictions: Instruction not permissible if - device in ramp mode,
 - device in calibration mode,
 - measurement in progress.

INSTrument[:NSElect]

DESCRIPTION: Changeover between the transmission and measurement modes.

SYNTAX: INSTrument [NSElect] <parameter>

Parameters: 0 -> The device assumes the transmission mode.
 1 -> The device assumes the measurement mode.

REMARKS:
 Enquiry form: INSTrument [NSElect]?

Response by the device: 0 -> If the device is in the transmission mode.
 1 -> If the device is in the measurement mode.

Restrictions: Instruction not permissible if - device in ramp mode,
 - device in calibration mode,
 - measurement in progress.

INSTrument:COUPle

DESCRIPTION: Simultaneous measurement and transmission is activated or deactivated.

SYNTAX: INSTrument COUPle <parameter>

Parameters: ALL -> Simultaneous transmission and measurement is activated.
 NONE -> Simultaneous transmission and measurement is deactivated.

REMARKS:
 Enquiry form: INSTrument COUPle?

Response by the device: ALL -> If simultaneous transmission and measurement is active.
 NONE -> If simultaneous transmission and measurement is inactive.

Restrictions: Instruction not permissible if - device in ramp mode,
 - device in calibration mode,
 - measurement in progress.

5.2.9 RAMP Subsystem

RAMP:STOP

DESCRIPTION:	The ramp is stopped.
SYNTAX:	RAMP:STOP
Parameters:	No parameters
REMARKS: Enquiry form:	No enquiry form
Restrictions:	This instruction is only permissible in the ramp mode.

RAMP:START

DESCRIPTION:	The ramp is started.
SYNTAX:	RAMP:START
Parameters:	No parameters
REMARKS: Enquiry form:	No enquiry form
Restrictions:	This instruction is only permissible in the ramp mode.

RAMP:STEP

DESCRIPTION:	The ramp sequence is executed in single steps.
SYNTAX:	RAMP:STEP <parameter>
Parameters:	UP -> The ramp goes forward by one step. DOWN -> The ramp goes back by one step.
REMARKS: Enquiry form:	No enquiry form
Restrictions:	This instruction is only permissible in the ramp mode.

5.2.10 SENSE Subsystem

SENSe:CORRection:OFFSet

DESCRIPTION:	The lead resistance for RTD measurement and transmission is set here. This instruction has the same function as the instruction SOURce:CORRection:OFFSet.
SYNTAX:	SENSe:CORRection:OFFSet <parameter>
Parameters:	The resistance in ohms without an explicit unit. Value range: $1\Omega \leq \text{parameter} \leq 99\Omega$
REMARKS: Enquiry form:	SENSe:CORRection:OFFSet?
Response:	The set resistance in ohms with a unit.
Restrictions:	Instruction not permissible if - device in calibration mode, - measurement in progress, - device in ramp mode.

SENSe:CORRection:OFFSet:STATe

DESCRIPTION: Here, you can specify whether or not the lead resistance RL should be considered for RTD measurement.

SYNTAX: SENSe:CORRection:OFFSet:STATe <parameter>

Parameters: ON or 1 -> RL is subtracted from the RTD measurement value,
OFF or 0 -> RL is not considered.

REMARKS:
Enquiry form: SENSe:CORRection:OFFSet:STATe?

Response: 1: -> If the RL function for RTD measurement is active,
0: -> If the RL function for RTD measurement is inactive.

Restrictions: Instruction not permissible if - device in calibration mode,
- measurement in progress,
- device in ramp mode.

SENSe:TCOuple:REFJunction

DESCRIPTION: The reference-junction type for thermocouple measurement is selected here.

SYNTAX: SENSe:TCOuple:REFJunction <parameter>

Parameters: RJ-INT -> Internal reference junction
RJ-MAN -> Manual reference junction
RJ-EXT -> External reference junction
4-20MA -> Current input 4 to 20 mA
0-20MA -> Current input 0 to 20 mA

REMARKS:
Enquiry form: SENSe:TCOuple:REFJunction?

Response: RJ-INT -> If the internal reference junction is active.
RJ-MAN -> If the manual reference junction is active.
RJ-EXT -> If the external reference junction is active.
4-20MA -> If the current input 4 to 20 mA is active.
0-20MA -> If the current input 0 to 20 mA is active.

Restrictions: Instruction not permissible if - device in ramp mode,
- device in calibration mode,
- measurement in progress.

SENSe:TCOuple:REFJunction:TMAN

DESCRIPTION: The reference junction temperature for RJ-MAN is set here.

SYNTAX: SENSe:TCOuple:REFJunction:TMAN <parameter>

Parameters: Temperature value in a range of 0 to 3000 K. If the parameter only consists of a numerical value, the default unit is used. It is also possible to transmit a unit explicitly.
C or CEL for degrees Celsius.
F or FAR for degrees Fahrenheit.
K for Kelvin.

REMARKS:
Enquiry form: SENSe:TCOuple:REFJunction:TMAN?

Response: The currently set value of the manual reference-junction temperature is supplied with the default unit.

Restrictions: Instruction not permissible if - device in ramp mode,
- device in calibration mode,
- measurement in progress.

SENSe:TCouple:REFJunction:TMINO

DESCRIPTION:	The temperature value related to 0 mA is set for RJ -> 0-20MA.
SYNTAX:	SENSe:TCouple:REFJunction:TMINO <parameter>
Parameters:	Temperature value in a range of 0 to 3000 K. If the parameter only consists of a numerical value, the default unit is used. It is also possible to transmit a unit explicitly. C or CEL for degrees Celsius. F or FAR for degrees Fahrenheit. K for Kelvin.
REMARKS: Enquiry form:	SENSe:TCouple:REFJunction:TMINO?
Response:	The temperature value related to 0 mA for RJ -> 0-20 MA is supplied with the default unit.
Restrictions:	Instruction not permissible if <ul style="list-style-type: none"> - device in ramp mode, - device in calibration mode, - measurement in progress.

SENSe:TCouple:REFJunction:TMAX0

DESCRIPTION:	The temperature value related to 20 mA is set for RJ -> 0-20MA.
SYNTAX:	SENSe:TCouple:REFJunction:TMAX0 <parameter>
Parameters:	Temperature value in a range of 0 to 3000 K. If the parameter only consists of a numerical value, the default unit is used. It is also possible to transmit a unit explicitly. C or CEL for degrees Celsius. F or FAR for degrees Fahrenheit. K for Kelvin.
REMARKS: Enquiry form:	SENSe:TCouple:REFJunction:TMAX0?
Response:	The temperature value related to 20 mA for RJ -> 0-20 MA is supplied with the default unit.
Restrictions:	Instruction not permissible if <ul style="list-style-type: none"> - device in ramp mode, - device in calibration mode, - measurement in progress.

SENSe:TCouple:REFJunction:TMIN4

DESCRIPTION:	The temperature value related to 4 mA is set for RJ -> 4-20MA.
SYNTAX:	SENSe:TCouple:REFJunction:TMIN4 <parameter>
Parameters:	Temperature value in a range of 0 to 3000 K. If the parameter only consists of a numerical value, the default unit is used. It is also possible to transmit a unit explicitly. C or CEL for degrees Celsius. F or FAR for degrees Fahrenheit. K for Kelvin.
REMARKS: Enquiry form:	SENSe:TCouple:REFJunction:TMIN4?
Response:	The temperature value related to 4 mA for RJ -> 4-20 MA is supplied with the default unit.
Restrictions:	Instruction not permissible if <ul style="list-style-type: none"> - device in ramp mode, - device in calibration mode, - measurement in progress.

SENSe:TCouple:REFJunction:TMAX4

DESCRIPTION:	The temperature value related to 20 mA is set for RJ -> 4-20MA.
SYNTAX:	SENSe:TCouple:REFJunction:TMAX4 <parameter>
Parameters:	Temperature value in a range of 0 to 3000 K. If the parameter only consists of a numerical value, the default unit is used. It is also possible to transmit a unit explicitly. C or CEL for degrees Celsius. F or FAR for degrees Fahrenheit. K for Kelvin.
REMARKS:	
Enquiry form:	SENSe:TCouple:REFJunction:TMAX4?
Response:	The temperature value related to 20 mA for RJ -> 4-20 MA is supplied with the default unit.
Restrictions:	Instruction not permissible if - device in ramp mode, - device in calibration mode, - measurement in progress.

SENSe:REFerence:STATe

DESCRIPTION:	The tara formation for measure P (pressure) is switched on and/or off.
SYNTAX:	SENSe:REFerence:STATe <parameter>
Parameters:	ON or 1 -> tara formation is switched on. OFF or 0 -> tara formation is switched off.
Enquiry form:	SENSe:REFerence:STATe?
Answer:	1 -> if tara formation is switched on. 0 -> if tara formation is switched off.
REMARKS:	
Restrictions:	The command is only allowed if measure P (pressure) is switched on (also with simultaneous transmission U/I or measure U/I). In following cases the command isn't allowed a measurement is started.

SENSe:REFerence:INITiate

DESCRIPTION:	The tara value is measures which should tares. Id the measurement ended so bit 11 from the Operation Status Regist is set.
SYNTAX:	SENSe:REFerence:INITiate
Parameters:	No parameter
Enquiry form:	No enquiry form:
REMARKS:	
Restrictions:	The command is only allowed if measure allowed if measure P (pressure) is switched on (also with simultaneous transmission U/I or measure U/I). The command is only allowed if the measurement stopped. With simultaneous transmission and measurement the tara value isn't showed on the display.

SENSe:REFerence:FETCh?

DESCRIPTION:	The away-tared value during pressure measurement can be queried.
SYNTAX:	SENSe:REFerence:FETCh?
Parameters:	No parameter
Enquiry form:	Only enquiry form
Answer:	The away-tared value with associated.
REMARKS:	
Restrictions:	The command is only allowed if measure P (pressure) is switched on (also with simultaneous transmission U/I or measure U/I). The command is only allowed if the measurement stopped.

5.2.11 SOURce Subsystem

SOURce:CORRection:COLLect

DESCRIPTION:	A zero offset of the U-transmission section is performed.	
SYNTAX:	SOURce:CORRection:COLLect <parameter>	
Parameters:	1 or ON -> 0 or OFF ->	A zero offset is performed. An ongoing zero offset is cancelled.
REMARKS:		
Enquiry form:	SOURce:CORRection:COLLect?	
Response:	1 -> 0 ->	Zero offset is active. Zero offset is inactive
Restrictions:	Instruction not permissible if - device in calibration mode, - (only) measurement in progress, - device in ramp mode.	

SOURce:CORRection:OFFSet

DESCRIPTION:	The lead resistance for RTD measurement and transmission is set here. This instruction has the same function as the instruction SENSe:CORRection:OFFSet.	
SYNTAX:	SOURce:CORRection:OFFSet <parameter>	
Parameters:	The resistance in ohms without an explicit unit. Value range: $1\Omega \leq \text{parameter} \leq 99\Omega$	
REMARKS:		
Enquiry form:	SOURce:CORRection:OFFSet?	
Response:	The set resistance in ohms with a unit.	
Restrictions:	Instruction not permissible if - device in calibration mode, - measurement in progress, - device in ramp mode.	

SOURce:CORRection:OFFSet:STATe

DESCRIPTION:	Here, you can specify whether or not the lead resistance RL should be considered for RTD transmission.
SYNTAX:	SOURce:CORRection:OFFSet:STATe <parameter>
Parameters:	ON or 1 -> RL is added to the RTD transmission value, OFF or 0 -> RL is not considered.
REMARKS:	
Enquiry form:	SOURce:CORRection:OFFSet:STATe?
Response:	1: -> If the RL function for RTD transmission is active, 0: -> If the RL function for RTD transmission is inactive.
Restrictions:	Instruction not permissible if - device in calibration mode, - measurement in progress, - device in ramp mode.

SOURce:CORRent[:LEVel][:IMMediate][:AMPLitude]

DESCRIPTION:	This instruction is meant to output a current value.
SYNTAX:	SOURce:CURRent[:LEVel][:IMMediate][:AMPLitude] <parameter>
Parameters:	Float value, with optional unit. Value range: - 22MA to 22MA Valid units: UA, MA, A, KA, MAA Default unit: A
REMARKS:	
Enquiry form:	SOURce:CURRent[:LEVel][:IMMediate][:AMPLitude]?
	On this enquiry, the actual current transmission value is supplied in exponential form (as amperes) without an explicit unit.
Restrictions:	Instruction not permissible if - device in calibration mode, - (only) measurement in progress, - device in ramp mode.

SOURce:VOLTage[:LEVel][:IMMediate][:AMPLitude]

DESCRIPTION:	This instruction is meant to output a voltage value.
SYNTAX:	SOURce:VOLTage[:LEVel][:IMMediate][:AMPLitude] <parameter>
Parameters:	Float value, with optional unit. Value range: Depending on the selection Valid units: UV, MV, V, KV, MAV Default unit: V
REMARKS:	
Enquiry form:	SOURce:VOLTage[:LEVel][:IMMediate][:AMPLitude]?
	On this enquiry, the actual voltage transmission value is supplied in exponential form (as volts) without an explicit unit.
Restrictions:	Instruction not permissible if - device in calibration mode, - (only) measurement in progress, - device in ramp mode.

SOURce:TCouple[:LEVel][:IMMediate][:AMPLitude]

DESCRIPTION:	This instruction is meant to simulate a temperature for a thermocouple.
SYNTAX:	SOURce:TCouple[:LEVel][:IMMediate][:AMPLitude] <parameter>
Parameters:	Float value, with optional unit. Value range: Depending on the thermocouple Valid units: C or CEL, F or FAR and K Default unit: Depending on the setting.
REMARKS: Enquiry form:	SOURce:TCouple[:LEVel][:IMMediate][:AMPLitude]? On this enquiry, the actual temperature transmission value is supplied as a numerical value followed by the currently selected unit.
Restrictions:	Instruction not permissible if - device in calibration mode, - measurement in progress, - device in ramp mode.

SOURce:RESistance[:LEVel][:IMMediate][:AMPLitude]

DESCRIPTION:	This instruction is meant to simulate a temperature or resistance value for a Pt 100 or Ni 100.
SYNTAX:	SOURce:RESistance[:LEVel][:IMMediate][:AMPLitude] <parameter>
Parameters:	Float value, with optional unit. Value range: Depending on the RTD Valid units: C or CEL, F or FAR, K, UOHM, MOHM, OHM, KOHM, MAOHM Default unit: Depending on the setting. If a changeover is made between OHM and a temperature unit, it becomes the new default unit.
REMARKS: Enquiry form:	SOURce:RESistance[:LEVel][:IMMediate][:AMPLitude]? On this enquiry, the actual RTD transmission value is supplied as a numerical value followed by the currently selected unit.
Restrictions:	Instruction not permissible if - device in calibration mode, - (only) measurement in progress, - device in ramp mode.

SOURce:STORe

DESCRIPTION:	The actual transmission value and corresponding delta-X value are stored.
SYNTAX:	SOURce:STORe <parameter>
Parameters:	Integer value between 0 and 9. This number corresponds to the memory number under which the value pair is stored.
REMARKS: Enquiry form:	No enquiry form
Restrictions:	Instruction not permissible if - device in calibration mode, - (only) measurement in progress, - device in ramp mode.

SOURce:RECall

DESCRIPTION:	The actual transmission value and corresponding delta-X value are retrieved from a memory location.
SYNTAX:	SOURce:RECall <parameter>
Parameters:	Integer value between 0 and 9. This number corresponds to the memory number from which the value pair is retrieved.
REMARKS: Enquiry form:	No enquiry form
Restrictions:	Instruction not permissible if - device in calibration mode, - (only) measurement in progress, - device in ramp mode.

SOURce:DELTA:ADD

DESCRIPTION:	The actual transmission value and corresponding delta-X value are added. The result is the new transmission value.
SYNTAX:	SOURce:DELTA:ADD
Parameters:	No parameters
REMARKS: Enquiry form:	No enquiry form
Restrictions:	Instruction not permissible if - device in calibration mode, - (only) measurement in progress, - device in ramp mode.

SOURce:DELTA:SUB

DESCRIPTION:	The delta-X value is subtracted from the actual transmission value. The result is the new transmission value.
SYNTAX:	SOURce:DELTA:SUB
Parameters:	No parameters
REMARKS: Enquiry form:	No enquiry form
Restrictions:	Instruction not permissible if - device in calibration mode, - (only) measurement in progress, - device in ramp mode.

SOURce:CURRENT:DELTA

DESCRIPTION:	This instruction is meant for setting a delta-X current value.
SYNTAX:	SOURce:CURRENT:DELTA <parameter>
Parameters:	Float value, with optional unit. Value range: 0 to 44MA Valid units: UA, MA, A, KA, MAA Default unit: A
REMARKS: Enquiry form:	SOURce:CURRENT:DELTA? On this enquiry, the delta-X current value is supplied in exponential form (as amperes) without an explicit unit.
Restrictions:	Instruction not permissible if - device in calibration mode, - (only) measurement in progress, - device in ramp mode.

SOURce:VOLTage:DELTA

DESCRIPTION: This instruction is meant to set a delta-X voltage value.

SYNTAX: SOURce:VOLTage:DELTA <parameter>

Parameters: Float value, with optional unit.
 Value range: 0 to 22MA
 Valid units: UV, MV, V, KV, MAV
 Default unit: V

REMARKS:
Enquiry form: SOURce:VOLTage:DELTA?

On this enquiry, the delta-X voltage value is supplied in exponential form (as volts) without an explicit unit.

Restrictions: Instruction not permissible if
 - device in calibration mode
 - (only) measurement in progress
 - device in ramp mode

SOURce:TCouple:DELTA

DESCRIPTION: This instruction is meant to set a delta-X TC-value.

SYNTAX: SOURce:TCouple:DELTA <parameter>

Parameters: Float value, with optional unit.
 Value range: 0 to 3000 K
 Valid units: C or CEL, F or FAR and K
 Default unit: Depending on the setting.

REMARKS:
Enquiry form: SOURce:TCouple:DELTA?

On this enquiry, the actual delta-X value is supplied as a numerical value followed by the currently selected unit.

Restrictions: Instruction not permissible if
 - device in calibration mode
 - (only) measurement in progress
 - device in ramp mode

SOURce:RESistance:DELTA

DESCRIPTION: This instruction is meant to set a delta-X RTD-value.

SYNTAX: SOURce:RESistance:DELTA <parameter>

Parameters: Float value, with optional unit.
 Value range: 0 to 3000 K or 0 to 2kΩ
 Valid units: C or CEL, F or FAR, K, UOHM, MOHM, OHM, KOHM, MAOHM
 Default unit: Depending on the setting.

REMARKS:
Enquiry form: SOURce:RESistance:DELTA?

On this enquiry, the actual delta-X RTD-value is supplied as a numerical value followed by the currently selected unit.

Restrictions: Instruction not permissible if
 - device in calibration mode
 - (only) measurement in progress
 - device in ramp mode

SOURce:TCouple:REFJunction

DESCRIPTION: The reference junction for TC transmission is set here.

SYNTAX: SOURce:TCouple:REFJunction <parameter>

Parameters: TC -> Internal reference junction
TC+RJ-MAN -> Manual reference junction
TC+RJ-AUT -> External reference junction
TC+4-20MA -> Current output 4 to 20 mA
TC+0-20MA -> Current output 0 to 20 mA

REMARKS:
Enquiry form: SOURce:TCouple:REFJunction?

Response: TC -> If the internal reference junction has been set.
TC+RJ-MAN -> If the manual reference junction has been set.
TC+RJ-AUT -> If the external reference junction has been set.
TC+4-20MA -> If the 4 to 20 mA current output has been set.
TC+0-20MA -> If the 0 to 20 mA current output has been set.

Restrictions: Instruction not permissible if - device in calibration mode
- (only) measurement in progress
- device in ramp mode

SOURce:TCouple:REFJunction:TMAN

DESCRIPTION: The reference-junction temperature for RJ->TC+RJ-MAN is set here.

SYNTAX: SOURce:TCouple:REFJunction:TMAN <parameter>

Parameters: Temperature value in a range of 0 to 3000 K. If the parameter only consists of a numerical value, the default unit is used. An explicit unit can also be transmitted.
C or CEL for degrees Celsius, F or FAR for degrees of Fahrenheit, K for Kelvin.

REMARKS:
Enquiry form: SOURce:TCouple:REFJunction:TMAN?

Response: The currently selected value of the manual reference-junction temperature is supplied with the default unit.

Restrictions: Instruction not permissible if - device in ramp mode
- device in calibration mode
- (only) measurement in progress

SOURce:TCouple:REFJunction:TMIN0

DESCRIPTION: The temperature value related to 0 mA is set here for RJ-> TC+0-20MA.

SYNTAX: SOURce:TCouple:REFJunction:TMIN0 <parameter>

Parameters: Temperature value in a range of 0 to 3000 K. If the parameter only consists of a numerical value, the default unit is used. An explicit unit can also be transmitted.
C or CEL for degrees Celsius, F or FAR for degrees of Fahrenheit, K for Kelvin.

REMARKS:
Enquiry form: SOURce:TCouple:REFJunction:TMIN0?
Response: The temperature value related to 0 mA for RJ-> TC+0-20MA is supplied with the default unit.

Restrictions: Instruction not permissible if - device in ramp mode
- device in calibration mode
- (only) measurement in progress

SOURce:TCouple:REFJunction:TMAX0

DESCRIPTION:	The temperature value related to 20 mA is set here for RJ-> TC+0-20MA.
SYNTAX:	SOURce:TCouple:REFJunction:TMAX0 <parameter>
Parameters:	Temperature value in a range of 0 to 3000 K. If the parameter only consists of a numerical value, the default unit is used. An explicit unit can also be transmitted. C or CEL for degrees Celsius, F or FAR for Grad Fahrenheit, K for Kelvin.
REMARKS: Enquiry form:	SOURce:TCouple:REFJunction:TMAX0?
Response:	The temperature value related to 20 mA for RJ-> TC+0-20MA is supplied with the default unit.
Restrictions:	Instruction not permissible if - device in ramp mode - device in calibration mode - (only) measurement in progress

SOURce:TCouple:REFJunction:TMIN4

DESCRIPTION:	The temperature value related to 4 mA is set here for RJ-> TC+4-20MA.
SYNTAX:	SOURce:TCouple:REFJunction:TMIN4 <parameter>
Parameters:	Temperature value in a range of 0 to 3000 K. If the parameter only consists of a numerical value, the default unit is used. An explicit unit can also be transmitted. C or CEL for degrees Celsius, F or FAR for Grad Fahrenheit, K for Kelvin.
REMARKS: Enquiry form:	SOURce:TCouple:REFJunction:TMIN4?
Response:	The temperature value related to 4 mA for RJ-> TC+4-20MA is supplied with the default unit.
Restrictions:	Instruction not permissible if - device in ramp mode - device in calibration mode - (only) measurement in progress

SOURce:TCouple:REFJunction:TMAX4

DESCRIPTION:	The temperature value related to 20 mA is set here for RJ-> TC+4-20MA.
SYNTAX:	SOURce:TCouple:REFJunction:TMAX4 <parameter>
Parameters:	Temperature value in a range of 0 to 3000 K. If the parameter only consists of a numerical value, the default unit is used. An explicit unit can also be transmitted. C or CEL for degrees Celsius, F or FAR for Grad Fahrenheit, K for Kelvin.
REMARKS: Enquiry form:	SOURce:TCouple:REFJunction:TMAX4?
Response:	The temperature value related to 20 mA for RJ-> TC+4-20MA is supplied with the default unit.
Restrictions:	Instruction not permissible if - device in ramp mode - device in calibration mode - (only) measurement in progress

SOURce:CURRent:RANGe:AUTO

DESCRIPTION:	Automatic or manual range selection for I transmission is set here.	
SYNTAX:	SOURce:CURRent:RANGe:AUTO <parameter>	
Parameters:	ON or 1 ->	Automatic range selection
	OFF or 0 ->	Manual range selection
REMARKS:		
Enquiry form:	SOURce:CURRent:RANGe:AUTO?	
Parameters:	ON or 1 ->	If automatic range selection is set
	OFF or 0 ->	If manual range selection is set
Restrictions:	Instruction not permissible if - device in ramp mode - device in calibration mode - (only) measurement in progress	

SOURce:CURRent:RANGe

DESCRIPTION:	The device receives a current value from which the current transmission range is determined in the case of manual range selection. At the same time, manual range selection for I transmission is set.	
SYNTAX:	SOURce:CURRent:RANGe <parameter>	
Parameters:	Float value, with optional unit.	
	Value range:	0 to 22mA
	Valid units:	UA, MA, A, KA, MAA
	Default unit:	A
REMARKS:		
Enquiry form:	SOURce:CURRent:RANGe?	
	On this enquiry, the current value is supplied in exponential form (as amperes) without an explicit unit.	
Restrictions:	Instruction not permissible if - device in ramp mode - device in calibration mode - (only) measurement in progress	

SOURce:VOLTage:RANGe:AUTO

DESCRIPTION:	Automatic or manual range selection for U transmission is set here.	
SYNTAX:	SOURce:VOLTage:RANGe:AUTO <parameter>	
Parameters:	ON or 1 ->	Automatic range selection
	OFF or 0 ->	Manual range selection
REMARKS:		
Enquiry form:	SOURce:VOLTage:RANGe:AUTO?	
Parameters:	ON or 1 ->	If automatic range selection is set
	OFF or 0 ->	If manual range selection is set
Restrictions:	Instruction not permissible if - device in ramp mode - device in calibration mode - (only) measurement in progress	

SOURce:VOLTage:RANGe

DESCRIPTION:	The device receives a voltage value from which the voltage transmission range is determined in the case of manual range selection. At the same time, manual range selection for U transmission is set.	
--------------	--	--

SYNTAX: SOURce:VOLTage:RANGe <parameter>

Parameters: Float value, with optional unit.
 Value range: 0 to 11V
 Valid units: UV, MV, V, KV, MAV
 Default unit: V

REMARKS:
 Enquiry form: SOURce:VOLTage:RANGe?

On this enquiry, the voltage value is supplied in exponential form (as volts) without an explicit unit.

Restrictions: Instruction not permissible if - device in ramp mode
 - device in calibration mode
 - (only) measurement in progress

SOURce:RESistance:RANGe:AUTO

DESCRIPTION: Automatic or manual range selection for RTD transmission is set here.

SYNTAX: SOURce:RESistance:RANGe:AUTO <parameter>

Parameters: ON or 1 -> Automatic range selection
 OFF or 0 -> Manual range selection

REMARKS:
 Enquiry form: SOURce:RESistance:RANGe:AUTO?

Parameters: ON or 1 -> f automatic range selection is set
 OFF or 0 -> If manual range selection is set

Restrictions: Instruction not permissible if - device in ramp mode
 - device in calibration mode
 - (only) measurement in progress

SOURce:RESistance:RANGe

DESCRIPTION: The device receives a temperature or resistance value from which the RTD transmission range is determined in the case of manual range selection. At the same time, manual range selection for RTD transmission is set.

SYNTAX: SOURce:RESistance:RANGe <parameter>

Parameters: Float value, with optional unit.
 Value range: 0 to 3000 K or 0 to 2kΩ,
 Valid units: C or CEL, F or FAR, K, UOHM, MOHM, OHM, KOHM, MAOHM
 Default unit: Depending on the setting

REMARKS:
 Enquiry form: SOURce:RESistance:RANGe ?

On this enquiry, the temperature or resistance value is supplied as a numerical value followed by the selected unit.

Restrictions: Instruction not permissible if - device in ramp mode
 - device in calibration mode
 - (only) measurement in progress

SOURce:MODE

DESCRIPTION: The transmission mode is set here: standard transmission, ramp 1 or ramp 2.

SYNTAX: SOURce:MODE <parameter>

REMARKS:
 Enquiry form: SOURce:CURRent:START?
 Response: The set current start-value in amperes. The unit is not transmitted.
 Restrictions: Instruction not permissible if - device in calibration mode
 - (only) measurement in progress
 - device in ramp mode

SOURce:VOLTage:START

DESCRIPTION: A voltage start-value for ramp 1 is set here.
 SYNTAX: SOURce:VOLTage:START <parameter>
 Parameters: Numerical value, with optional unit.
 Value range: -11 to 11V
 Valid units: UV, MV, V, KV, MAV
 Default unit: V

REMARKS:
 Enquiry form: SOURce:VOLTage:START?
 Response: The set voltage start-value in volts. The unit is not transmitted.
 Restrictions: Instruction not permissible if - device in calibration mode
 - (only) measurement in progress
 - device in ramp mode

SOURce:TCouple:START

DESCRIPTION: A TC start-value for ramp 1 is set here.
 SYNTAX: SOURce:TCouple:START <parameter>
 Parameters: Numerical value, with optional unit.
 Value range: 0 to 3000 K or 0 to 2kΩ
 Valid units: C or CEL, F or FAR and K
 Default unit: Depending on the setting

REMARKS:
 Enquiry form: SOURce:TCouple:START?
 Response: The actual TC start-value with the selected unit.
 The unit string is also transmitted.
 Restrictions: Instruction not permissible if - device in calibration mode
 - (only) measurement in progress
 - device in ramp mode

SOURce:RESistance:START

DESCRIPTION: An RTD start-value for ramp 1 is set here.
 SYNTAX: SOURce:RESistance:START <parameter>
 Parameters: Numerical value, with optional unit.
 Value range: 0 to 3000 K or 0 to 2kΩ
 Valid units: C or CEL, F or FAR and K
 UOHM, MOHM, OHM, KOHM, MAOHM
 Default unit: Depending on the setting

REMARKS:
 Enquiry form: SOURce:RESistance:START?

Response: The actual RTD start-value with the selected unit.
The unit string is also transmitted.

Restrictions: Instruction not permissible if - device in calibration mode
- (only) measurement in progress
- device in ramp mode

SOURce:CURRent:STOP

DESCRIPTION: A current final-value for ramp 1 is set here.

SYNTAX: SOURce:CURRent:STOP <parameter>

Parameters: Numerical value, with optional unit.
Value range: -22 to 22mA
Valid units: UA, MA, A, KA, MAA
Default unit: A

REMARKS:
Enquiry form: SOURce:CURRent:STOP?

Response: The set current final-value in amperes. The unit is not transmitted.

Restrictions: Instruction not permissible if - device in calibration mode
- (only) measurement in progress
- device in ramp mode

SOURce:VOLTage:STOP

DESCRIPTION: A voltage final-value for ramp 1 is set here.

SYNTAX: SOURce:VOLTage:STOP <parameter>

Parameters: Numerical value, with optional unit.
Value range: -11 to 11V
Valid units: UV, MV, V, KV, MAV
Default unit: V

REMARKS:
Enquiry form: SOURce:VOLTage:STOP?

Response: The set voltage final-value in volts. The unit is not transmitted.

Restrictions: Instruction not permissible if - device in calibration mode
- (only) measurement in progress
- device in ramp mode

SOURce:TCouple:STOP

DESCRIPTION: A TC final-value for ramp 1 is set here.

SYNTAX: SOURce:TCouple:STOP <parameter>

Parameters: Numerical value, with optional unit.
Value range: 0 to 3000 K or 0 to 2kΩ
Valid units: C or CEL, F or FAR and K
Default unit: Depending on the setting

REMARKS:
Enquiry form: SOURce:TCouple:STOP?

Response: The actual TC final-value with the selected unit.
The unit string is also transmitted.

Restrictions: Instruction not permissible if - device in calibration mode
- (only) measurement in progress
- device in ramp mode

SOURce:RESistance:STOP

DESCRIPTION:	An RTD final-value for ramp 1 is set here.
SYNTAX:	SOURce:RESistance:STOP <parameter>
Parameters:	Numerical value, with optional unit. Value range: 0 to 3000 K or 0 to 2kΩ Valid units: C or CEL, F or FAR, K UOHM, MOHM, OHM, KOHM, MAOHM Default unit: Depending on the setting
REMARKS:	
Enquiry form:	SOURce:RESistance:STOP?
Response:	The actual RTD final-value with the selected unit. The unit string is also transmitted.
Restrictions:	Instruction not permissible if - device in calibration mode - (only) measurement in progress - device in ramp mode

SOURce:CURRent:STEP

DESCRIPTION:	A current delta-value for ramp 1 is set here.
SYNTAX:	SOURce:CURRent:STEP <parameter>
Parameters:	Numerical value, with optional unit. Value range: 0 to 44mA Valid units: UA, MA, A, KA, MAA Default unit: A
REMARKS:	
Enquiry form:	SOURce:CURRent:STEP?
Response:	The set current delta-value in amperes. The unit is not transmitted.
Restrictions:	Instruction not permissible if - device in calibration mode - device in ramp mode - (only) measurement in progress

SOURce:VOLTage:STEP

DESCRIPTION:	A voltage delta-value for ramp 1 is set here.
SYNTAX:	SOURce:VOLTage:STEP <parameter>
Parameters:	Numerical value, with optional unit. Value range: 0 to 22V Valid units: UV, MV, V, KV, MAV Default unit: V
REMARKS:	
Enquiry form:	SOURce:VOLTage:STEP?
Response:	The set voltage delta-value in volts. The unit is not transmitted.
Restrictions:	Instruction not permissible if - device in calibration mode - (only) measurement in progress - device in ramp mode

SOURce:TCouple:STEP

DESCRIPTION:	A TC delta-value for ramp 1 is set here.
SYNTAX:	SOURce:TCouple:STEP <parameter>
Parameters:	Numerical value, with optional unit. Value range: 0 to 3000 K or 0 to 2k Ω Valid units: C or CEL, F or FAR and K Default unit: Depending on the setting
REMARKS: Enquiry form:	SOURce:TCouple:STEP?
Response:	The actual TC delta-value with the selected unit. The unit string is also transmitted.
Restrictions:	Instruction not permissible if - device in calibration mode - (only) measurement in progress - device in ramp mode

SOURce:RESistance:STEP

DESCRIPTION:	An RTD delta-value for ramp 1 is set here.
SYNTAX:	SOURce:RESistance:STEP <parameter>
Parameters:	Numerical value, with optional unit. Value range: 0 to 3000 K or 0 to 2k Ω Valid units: C or CEL, F or FAR, K UOHM, MOHM, OHM, KOHM, MAOHM Default unit: Depending on the setting
REMARKS: Enquiry form:	SOURce:RESistance:STEP?
Response:	The actual RTD delta-value with the selected unit. The unit string is also transmitted.
Restrictions:	Instruction not permissible if - device in calibration mode - (only) measurement in progress - device in ramp mode

SOURce:SWEep:DWELi

DESCRIPTION:	The delta time for ramp 1 is set here.
SYNTAX:	SOURce:SWEep:DWELi <parameter>
Parameters:	The required delta time in seconds. Only a numerical value, without a unit. Value range: 0.1 to 99999.9
REMARKS: Enquiry form:	SOURce:SWEep:DWELi?
Response:	The selected delta time for ramp 1 in seconds. The unit is not transmitted.
Restrictions:	Instruction not permissible if - device in calibration mode - (only) measurement in progress - device in ramp mode

SOURce:LIST:WAVeform

DESCRIPTION: The waveform for ramp 2 is set here.

SYNTAX: SOURce:LIST:WAVeform <parameter>

Parameters: TRIangle -> Triangular waveform.
SAWTooth -> Sawtooth waveform.

REMARKS:
Enquiry form: SOURce:LIST:WAVeform?

Parameters: TRI -> If a triangular waveform has been set.
SAWT -> If a sawtooth waveform has been set.

Restrictions: Instruction not permissible if - device in calibration mode
- (only) measurement in progress
- device in ramp mode

SOURce:LIST:COUNT

DESCRIPTION: The number of passes by ramp 2 is set here.

SYNTAX: SOURce:LIST:COUNT <parameter>

Parameters: Number of passes.
Value range: 0 to 99
0 -> Continuous pass

REMARKS:
Enquiry form: SOURce:LIST:COUNT?

Response: Set number of passes.

Restrictions: Instruction not permissible if - device in calibration mode
- (only) measurement in progress
- device in ramp mode

SOURce:LIST:POINTs

DESCRIPTION: The number of active stages for ramp 2 is set.

SYNTAX: SOURce:LIST:POINTs <parameter>

Parameters: Number of active stages.
Value range: 2 to 30

REMARKS:
Enquiry form: SOURce:LIST:POINTs?

Response: The current number of stages for ramp 2.

Restrictions: Instruction not permissible if - device in calibration mode
- (only) measurement in progress
- device in ramp mode

SOURce:LIST:NUMBer

DESCRIPTION: A list number is sent from ramp 2 to the device. This list contains a total of 30 value-pairs (transmission values and delta-time). The value-pair corresponding to this list number can be set via the interface.

SYNTAX: SOURce:LIST:NUMBer <parameter>

Parameters: The list number
Value range: 1 to 30

REMARKS:
Enquiry form: SOURce:LIST:NUMBer?

Response: The currently selected list number.

Restrictions: Instruction not permissible if
 - device in calibration mode
 - (only) measurement in progress
 - device in ramp mode

SOURce:LIST:CURRent

DESCRIPTION: For setting ramp 2. The current value of the list element corresponding to the selected list number is set here. The list number is selected with the SOURce:LIST:NUMBER instruction.

SYNTAX: SOURce:LIST:CURRent <parameter>

Parameters: Numerical value, with optional unit.
 Value range: -22 to 22mA
 Valid units: UA, MA, A, KA, MAA
 Default unit: A

REMARKS:
 Enquiry form: SOURce:LIST:CURRent?

Response: The set current value (in amperes) for the selected list element. The unit string is also transmitted.

Restrictions: Instruction not permissible if
 - device in calibration mode
 - (only) measurement in progress
 - device in ramp mode

SOURce:LIST:VOLTage

DESCRIPTION: For setting ramp 2. The voltage value of the list element corresponding to the selected list number is set here. The list number is selected with the SOURce:LIST:NUMBER instruction.

SYNTAX: SOURce:LIST:VOLTage <parameter>

Parameters: Numerical value, with optional unit.
 Value range: -11 to 11V
 Valid units: UV, MV, V, KV, MAV
 Default unit: V

REMARKS:
 Enquiry form: SOURce:LIST:VOLTage?

Response: The set voltage value (in volts) for the selected list element. The unit string is also transmitted.

Restrictions: Instruction not permissible if
 - device in calibration mode
 - (only) measurement in progress
 - device in ramp mode

SOURce:LIST:TCouple

DESCRIPTION: For setting ramp 2. The TC value of the list element corresponding to the selected list number is set here. The list number is selected with the SOURce:LIST:NUMBER instruction.

SYNTAX: SOURce:LIST:TCouple <parameter>

Parameters: Numerical value, with optional unit.
 Value range: 0 to 3000 K or 0 to 2kΩ
 Valid units: C or CEL, F or FAR and K.
 Default unit: Depending on the setting

REMARKS:
 Enquiry form: SOURce:LIST:TCouple?

Response: The set TC value for the selected list element with the selected unit. The unit string is also transmitted.

Restrictions: Instruction not permissible if
 - device in calibration mode
 - (only) measurement in progress
 - device in ramp mode

SOURce:LIST:RESistance

DESCRIPTION:	For setting ramp 2. The RTD value of the list element corresponding to the selected list number is set here. The list number is selected with the SOURce:LIST:NUMBer instruction.
SYNTAX:	SOURce:LIST:RESistance <parameter>
Parameters:	Numerical value, with optional unit. Value range: 0 to 3000 K or 0 to 2k Ω Valid units: C or CEL, F or FAR, K, UOHM, MOHM, OHM, KOHM, MAOHM Default unit: Depending on the setting
REMARKS: Enquiry form:	SOURce:LIST:RESistance?
Response:	The set RTD value for the actual list element with the selected unit. The unit string is also transmitted.
Restrictions:	Instruction not permissible if - device in calibration mode - (only) measurement in progress - device in ramp mode

SOURce:LIST:DWELi

DESCRIPTION:	For setting ramp 2. The delta-time of the list element corresponding to the selected list number is set here. The list number is selected with the SOURce:LIST:NUMBer instruction.
SYNTAX:	SOURce:LIST:DWELi <parameter>
Parameters:	Delta time in seconds. Value range: 0.1 to 99999.9 The unit is not transmitted.
REMARKS: Enquiry form:	SOURce:LIST:DWELi?
Response:	The set delta-time (in seconds) of the selected list element. The unit string is also transmitted.
Restrictions:	Instruction not permissible if - device in calibration mode - (only) measurement in progress - device in ramp mode

SOURce:LIST:VALue

DESCRIPTION:	The ramp 2 transmission value of the list element corresponding to the selected list number is fetched here. The list number is selected with the SOURce:LIST:NUMBer instruction.
SYNTAX:	SOURce:LIST:VALue <parameter>
Parameters:	No parameters
REMARKS: Enquiry form:	Only enquiry form
Response:	If the selected list element is a voltage transmission value: The voltage transmission value in volts. If the selected list element is a current transmission value: The current transmission value in milliamperes. If the selected list element is a TC or RTD transmission value: The transmission value with the selected unit string.
Restrictions:	Instruction not permissible if - device in calibration mode - (only) measurement in progress - device in ramp mode

5.2.12 STATus Subsystem

STATus:OPERation:CONDition?

DESCRIPTION: The Operation Status Condition Register is read out.

SYNTAX: STATus:OPERation:CONDition?

Parameters: No parameters

REMARKS:
Enquiry form: Only enquiry form
The contents of the register are supplied as a decimal value (0 to 32767).

STATus:OPERation:ENABLE

DESCRIPTION: The Operation Status Enable Register is set.

SYNTAX: STATus:OPERation:ENABLE <parameter>

Parameters: Decimal value
Value range: 0 to 32767

REMARKS:
Enquiry form: STATus:OPERation:ENABLE?
The contents of the register are supplied as a decimal value (0 to 32767).

STATus:OPERation[:EVENT]?

DESCRIPTION: The Operation Status Event Register is read out.

SYNTAX: SOURce:CORRection:[EVENT]?

Parameters: No parameters

REMARKS:
Enquiry form: Only enquiry form.
The contents of the register are supplied as a decimal value (0 to 32767).

STATus:QUEStionable:CONDition?

DESCRIPTION: The Questionable Status Condition Register is read out.

SYNTAX: STATus:QUEStionable:CONDition?

Parameters: No parameters

REMARKS:
Enquiry form: Only enquiry form.
The contents of the register are supplied as a decimal value (0 to 32767).

STATus:QUEStionable:ENABLE

DESCRIPTION: The Questionable Status Enable Register is read out.

SYNTAX: STATus:QUEStionable:ENABLE <parameter>

Parameters: Decimal value
Value range: 0 to 32767

REMARKS:
Enquiry form: STATus:QUESTionable:ENABLE?
The contents of the register are supplied as a decimal value (0 to 32767).

STATus:QUESTionable[EVENT]?

DESCRIPTION: The Questionable Status Event Register is read out.

SYNTAX: STATus:QUESTionable[EVENT]?

Parameters: No parameters

REMARKS:
Enquiry form: Only enquiry form.
The contents of the register are supplied as a decimal value (0 to 32767).

STATus:PRESet

DESCRIPTION: The Operation Status Enable Register and Questionable Status Enable Register are reset.

SYNTAX: STATus:PRESet

Parameters: No parameters
Value range: 0 to 32767

REMARKS:
Enquiry form: No enquiry form

5.2.13	SYSTEM Subsystem
--------	------------------

SYSTEM:ERRor?

DESCRIPTION: The contents of the error buffer are requested.

SYNTAX: SYSTEM:ERRor?

Parameters: No parameters

REMARKS:
Enquiry form: Only enquiry form
The error buffer has a size of 2. One buffer for the first error message and one buffer for the "QEU OVERFLOW" message.

The error buffer is a "First In First Out" buffer.

When an error is read out of the buffer, it is erased.

If no error has occurred, the device responds with „NO ERROR“.

An error message consists of:

<Error message>,"<Error description>"

List of error messages:

0, "NO ERROR"	No error has occurred.
-100, "COMMAND ERROR"	An invalid instruction was sent.
-101, "INVALID CHARACTER"	An instruction contains an invalid character.
-105, "GET NOT ALLOWED"	A GET-instruction was sent as part of another instruction.
-109, "MISSING PARAMETER"	A parameter is missing.
-110, "COMMAND HEADER ERROR"	Invalid instruction header.
-120, "NUMERIC DATA ERROR"	Invalid numerical value.
-200, "EXECUTION ERROR"	An instruction could not be executed due to a particular device state.
-213, "INIT IGNORED"	The INITIALize instruction was ignored.
-220, "PARAMETER ERROR"	An instruction with an incorrect parameter was sent.
-221, "SETTING CONFLICT"	A valid instruction could not be executed due to the device state.
-222, "DATA OUT OF RANGE"	A parameter lies outside the permissible limits.
-224, "ILLEGAL PARAMETER VALUE"	A valid SCPI parameter which, however, is not used by the device.
-231, "DATA QUESTIONABLE"	The value of a parameter is questionable.
-350, "QUEUE OVERFLOW"	Overflow in the error buffer.
-400, "QUERY ERROR"	The device was requested for non-existent data.
-410, "QUERY INTERRUPTED"	The device was interrupted before a response was completed.
-420, "QUERY UNTERMINATED"	The device did not send a complete response.
110, "VOLTAGE OVERRANGE"	A voltage value could not be output.
120, "VOLTAGE OVER"	The overrange bit for voltage transmission is set.
130, "VOLTAGE LIMIT"	The limiting bit for voltage transmission is set.
210, "CURRENT OVERRANGE"	A current value could not be output.
220, "CURRENT OVER ,"	The overrange bit for current transmission is set.
230, "CURRENT LIMIT"	The limiting bit for current transmission is set.
500, "TEMPEARTURE ERROR"	Temperature error.
510, "TEMPERATURE OVERRANGE"	Invalid temperature for TC transmission.
520, "TEMPERATURE OVERRANGE"	Invalid temperature for TC measurement.

SYSTem:KLOCK

DESCRIPTION: The Operation Status Condition Register is read out.

SYNTAX: SYSTem:KLOCK <parameter>

Parameters: 1 or ON -> Keyboard is disabled.
0 or OFF -> Keyboard is enabled.

REMARKS:
Enquiry form: SYSTem:KLOCK?
If the keyboard is disabled, a 1 is supplied.
If the keyboard is enabled, a 0 is supplied.

Reset value: OFF or 0

SYSTem:VERSion?

DESCRIPTION: The SCPI version is requested.

SYNTAX: SYSTem:VERSion?

Parameters: No parameters.

REMARKS:
Enquiry form: Only enquiry form.

Response by the device: 1993.0

SYSTem:DATE

DESCRIPTION: The date can be set and requested.

SYNTAX: SYSTem:DATE <parameter>

Parameters: yyyy,mm,dd
yyyy -> Year
dd -> Day of the month (1-31)
mm -> Month (1-12)

REMARKS:
Enquiry form: SYSTem:DATE?

Response by the device: dd,mm,yy
dd -> Day of the month
mm -> Month
yy -> Year

SYSTem:TIME

DESCRIPTION: The time can be set and requested.

SYNTAX: SYSTem:TIME <parameter>

Parameters: hh,mm,ss
hh -> Hours (0-23)
mm -> Minutes (0-59)
ss -> Seconds (0-59)

REMARKS:
Enquiry form: SYSTem:TIME?

Response by the device: hh,mm,ss
hh -> Hours
mm -> Minutes
ss -> Seconds

5.2.14	TRIGger Subsystem, ABORT, INITiate
--------	------------------------------------

ABORt

DESCRIPTION: A measurement is stopped.

SYNTAX: ABORt

Parameters: No parameters

REMARKS:
Enquiry form: No enquiry form

Restrictions: Instruction not permissible if

- device in data logger mode
- device in calibration mode
- device in ramp mode
- device in transmission (only) mode.

INITiate[IMMediate]

DESCRIPTION: A measurement is started.

SYNTAX: INITiate[IMMediate]

Parameters: No parameters

REMARKS:
Enquiry form: No enquiry form

Restrictions: Instruction not permissible if

- device in data logger mode
- device in calibration mode
- device in ramp mode
- device in transmission (only) mode.

5.2.15	UNIT Subsystem
--------	----------------

UNIT:TEMPerature:TCOuple

DESCRIPTION: The unit for measuring and simulating a thermocouple is set here.

SYNTAX: UNIT:TEMPerature:TCOuple <parameter>

Parameters:

K	->	The Kelvin unit is selected.
C or CEL	->	The Celsius unit is selected.
F or FAR	->	The Fahrenheit unit is selected.

REMARKS:
Enquiry form: UNIT:TEMPerature:TCOuple?

K	->	If the Kelvin unit has been selected.
C or CEL	->	If the Celsius unit has been selected.
F or FAR	->	If the Fahrenheit unit has been selected.

Restrictions: Instruction not permissible if

- device in calibration mode
- device in ramp mode
- measurement in progress.

UNIT:TEMPerature:FRTD

DESCRIPTION:	The unit for measuring and simulating a Pt100 is set here.	
SYNTAX:	UNIT:TEMPerature:FRTD <parameter>	
Parameters:	K ->	The Kelvin unit is selected.
	C or CEL ->	The Celsius unit is selected.
	F or FAR ->	The Farenheit unit is selected.
	OHM ->	The Ω unit is selected.
REMARKS:		
Enquiry form:	UNIT:TEMPerature:FRTD?	
	K ->	If the Kelvin unit has been selected.
	C or CEL ->	If the Celsius unit has been selected.
	F or FAR ->	If the Farenheit unit has been selected.
	OHM ->	If the Ω unit has been selected.
Restrictions:	Instruction not permissible if	<ul style="list-style-type: none"> - device in calibration mode - device in ramp mode - measurement in progress.

UNIT:P

DESCRIPTION:	The unit with measure P can be switsched between the unit of pressure and V and/or mV.	
SYNTAX:	UNIT:P <parameter>	
Parameters:	V →	Unit V (mV) is selected
	P →	Unit of pressure is selected
Enquiry form:	UNIT:P?	
Answer:	V →	If unit V (mV) is selected
	P →	If unit of pressure is selected
REMARKS:		
Restrictions:	In the following cases the command is not permitted: <ul style="list-style-type: none"> - a measurement is started - the equipment is in the adjustment mode - the equipment is in the ramp mode 	

5.2.16 IEEE488.2 Instructions

*CLS

DESCRIPTION:	The device is set to the Operation-Complete-Idle state. The device is set to the Operation-Query-Idle state. The error buffer is cleared. The Operations-Status-Register is reset. The Questionable-Status-Register is reset. The Standard-Event-Register is reset. The status byte is reset.	
SYNTAX:	*CLS	
Parameters:	No parameters	
REMARKS:		
Enquiry form:	No enquiry form	

***ESE**

DESCRIPTION: The Standard-Event-Status-Enable-Register is set.
The status byte is reset.

SYNTAX: *ESE <parameter>

Parameters: Value range: 0 to 255
The decimal value corresponds to the bit combination in the 8-bit register.

REMARKS:
Enquiry form: *ESE?
The setting pointer of the Standard-Event-Status-Enable-Registers is supplied.

***ESR**

DESCRIPTION: The Standard-Event-Status-Register is read out and then reset.

SYNTAX: *ESR?

Parameters: No parameters

REMARKS:
Enquiry form: Only enquiry form
A decimal value between 0 and 255 is supplied, depending on the contents of the register.

***IDN**

DESCRIPTION: The identification of the device is requested.
- Name of the device
- Software version of the device
- Calibration status

SYNTAX: *IDN?

Parameters: No parameters

REMARKS:
Enquiry form: Only enquiry form

Response by the device: BURSTER,DIGISTANT 4420-V001,VERSION:VXXXX,CAL: CXXX

***OPC**

DESCRIPTION: The device is set to the Operation-Complete-Active-State (OCAS). In this state, the Operation-Complete-Bit in the Standard-Event-Register is set after the completion of an operation.

SYNTAX: *OPC

Parameters: No parameters

REMARKS:
Enquiry form: The enquiry form of this instruction has a different function.
It is therefore described separately.

*OPC?	
DESCRIPTION:	The device is set to the Operation-Complete-Query-Active-State (OCQAS). In this state, the device writes "1<CR><LF>" to the output buffer after the completion of an instruction.
SYNTAX:	*OPC?
Parameters:	No parameters
REMARKS:	
Enquiry form:	Only enquiry form. The same instruction without an enquiry form has a different meaning. Refer to its separate description.
*RST	
DESCRIPTION:	The device is set to a defined, initial state. Interfaces are not influenced here, and the device remains in the remote state.
SYNTAX:	*RST
Parameters:	No parameters
REMARKS:	
Enquiry form:	No enquiry form
*SRE	
DESCRIPTION:	The Service-Request-Enable-Register is set.
SYNTAX:	*SRE <parameter>
Parameters:	Value range: 0 to 255 Decimal value corresponding to the bit combination in the 8-bit register.
REMARKS:	
Enquiry form:	*SRE? The device responds with a decimal value between 0 and 255, depending on the present contents of the register.
*STB?	
DESCRIPTION:	The status byte is read out (a 488.2 register with the summary bits).
SYNTAX:	*STB?
Parameters:	No parameters
REMARKS:	
Enquiry form:	Only enquiry form The device responds with a decimal value between 0 and 255, depending on the present contents of the register.
*TST?	
DESCRIPTION:	Self-Test-Query instruction. This instruction is recognized by the 6706 but does not have any effect.
SYNTAX:	*TST?
Parameters:	No parameters
REMARKS:	
Enquiry form:	Only enquiry form

***WAI**

DESCRIPTION: This instruction sets a device such that all instructions are executed sequentially. This instruction does not have any effect in the 6706, as instructions are always processed sequentially.

SYNTAX: *WAI

Parameters: No parameters

REMARKS:
Enquiry form: No enquiry form

***SAV**

DESCRIPTION: A device setting is stored.
Up to 4 settings can be stored.

SYNTAX: *SAV <parameter>

Parameters: A number under which the device setting is to be stored.
Value range: 1 <=number<= 4

REMARKS:
Enquiry form: No enquiry form

Response: -

Restrictions: Instruction not permissible if - device in ramp mode
- device in calibration mode
- measurement in progress

***RCL**

DESCRIPTION: A stored device setting is loaded.
Up to 5 settings can be loaded.

SYNTAX: *RCL <parameter>

Parameters: The number of the device setting to be loaded.
Value range: 1 <= number <= 5
5 loads the default setting.

REMARKS:
Enquiry form: No enquiry form

Restrictions: Instruction not permissible if - device in ramp mode
- device in calibration mode
- measurement in progress

5.2.17 Status Register

Standard Event Status Register

Bits used	Meaning
Bit 0 Operation Complete	The bit is set as a response to the *OPC instruction. It indicates that the last instruction has been executed.
Bit 2 Query Error	This bit indicates that: 1. Non-existent data has been requested or 2. Data in the output buffer has been lost.
Bit 3 Device Dependent Error	If a value cannot be measured or transmitted.
Bit 4 Execution Error	This bit is set when an incorrect parameter is sent.
Bit 5 Command Error	An instruction is not recognized by the SCPI interpreter.

QUESTionable Status Register

Bits used	Meaning
Bit 0 VOLTage	A voltage cannot be transmitted or a voltage cannot be measured.
Bit 1 CURRent	A current cannot be transmitted or a current cannot be measured.
Bit 4 TEMPerature	A temperature cannot be transmitted or a temperature cannot be measured.
Bit 8 CALibration	An error has occurred during calibration.
Bit 9 LOWBAT	Accumulator empty.
Bit 10 OUT OVER	Transmission section over range.
Bit 11 IN OVER	Measurement section over range.
Bit 14 Command Warning	An SCPI instruction contains a parameter although none are expected.

OPERation Status Register

Bits used	Meaning
Bit 0 CALibrating	The device is performing a calibration.
Bit 4 Measuring	The device is performing a measurement.
Bit 8 MAV	A measured value is available.
Bit 9 P-MAV	A measured P value is available
Bit 10 Bat-MAV	A measured battery voltage value is available
Bit 11 Tare-MAV	Tare value is available

5.2.18 CStat Subsystem

The instructions of this subsystem are meant for status examination after faulty calibration. The statuses of the individual calibration values are stored in registers. In case of an error, the corresponding bit is set to 1. The error status remains valid until the calibration mode is invoked again.

CStat:I?

DESCRIPTION: The calibration status of the current transmission and measurement section can be requested here.

SYNTAX: CStat:I

Parameters: No parameters

REMARKS:

Enquiry form: Only enquiry form

Response by the device: A 16-bit word in decimal form. In case of an error, the corresponding bit is set to 1.

Bits	Meaning
D0	I transm., 2mA, offset
D1	I transm., 22mA, offset
D2	I transm., -2mA, offset
D3	I transm., -22mA, offset
D4	I transm., 2mA, slope
D5	I transm., 22mA, slope
D6	I transm., -2mA, slope
D7	I transm., -22mA, slope
D8	I measr., offset
D9	I measr., slope
D10 to D15	No meaning

CStat:IN?

DESCRIPTION: The calibration status of the voltage measurement section can be requested here.

SYNTAX: CStat:IN?

Parameters: No parameters

REMARKS:

Enquiry form: Only enquiry form

Response by the device: A 18-bit word in decimal form. In case of an error, the corresponding bit is set to 1.

Bits	Meaning		
D0	U measr.,	10mV,	offset
D1	U measr.,	100MV,	offset
D2	U measr.,	1V,	offset
D3	U measr.,	11V,	offset
D4	U measr.,	10mV,	slope
D5	U measr.,	100mV,	slope
D6	U measr.,	1V,	slope
D7	U measr.,	11V,	slope

CStat:OUT?

DESCRIPTION: The calibration status of the voltage transmission section can be requested here.

SYNTAX: CStat:OUT?

Parameters: No parameters

REMARKS:

Enquiry form: Only enquiry form

Response by the device: A 16-bit word in decimal form. In case of an error, the corresponding bit is set to 1.

Bits	Meaning		
D0	U transm.,	10mV,	offset
D1	U transm.,	100MV,	offset
D2	U transm.,	1V,	offset
D3	U transm.,	11V,	offset
D4	U transm.,	-10mV,	offset
D5	U transm.,	-100 mV,	offset
D6	U transm.,	-1mV,	offset
D7	U transm.,	-11V,	offset
D8	U transm.,	10mV,	slope
D9	U transm.,	100mV,	slope
D10	U transm.,	1V,	slope
D11	U transm.,	11V,	slope
D12	U transm.,	-10mV,	slope
D13	U transm.,	-100mV,	slope
D14	U transm.,	-1V,	slope
D15	U transm.,	-11V,	slope

CStat:U:IN?

DESCRIPTION: The adjustment status of voltage-measure-part can be queried.

SYNTAX: CStat:U:IN?

Parameters: No parameter

REMARKS:

Enquiry form: Only enquiry form

Response by the device: a 18 bit word in decimal form. In the case of an error the appropriate bit is set to 1.

Bits	Meaning	
D0	RTD measr.,	180 Ω reference resistance
D1	RTD measr.,	1.98 kΩ reference resistance
D2	RTD measr.,	correction factor from internal Pt100

CStat:R:OUT?

DESCRIPTION: The calibration status of the RTD transmission section can be requested here.

SYNTAX: CStat:R:OUT?

Parameters: No parameters

REMARKS:

Enquiry form: Only enquiry form

Response by the device: A 16-bit word in decimal form. In case of an error, the corresponding bit is set to 1.

Bits	Meaning			
D0	RTD transm.,	200Ω	I small and positive,	offset
D1	RTD transm.,	200Ω,	I large and positive,	offset
D2	RTD transm.,	2kΩ,	I small and positive,	offset
D3	RTD transm.,	2kΩ,	I large and positive,	offset
D4	RTD transm.,	200Ω,	I small and negative,	offset
D5	RTD transm.,	200Ω,	I large and negative,	offset
D6	RTD transm.,	2kΩ,	I small and negative,	offset
D7	RTD transm.,	2kΩ,	I large and negative,	offset
D8	RTD transm.,	200Ω,	I small and positive,	slope
D9	RTD transm.,	200Ω,	I large and positive,	slope
D10	RTD transm.,	2kΩ,	I small and positive,	slope
D11	RTD transm.,	2kΩ,	I large and positive,	slope
D12	RTD transm.,	200Ω,	I small and negative,	slope
D13	RTD transm.,	200Ω,	I large and negative,	slope
D14	RTD transm.,	2kΩ,	I small and negative,	slope
D15	RTD transm.,	2kΩ,	I large and negative,	slope

5.2.19 ROUTe Subsystem

ROUTe:MODule:DEFine

DESCRIPTION: The designation of a pressure module is received.
A marking is assigned to a pressure module with the number 0 to 9.

SYNTAX: ROUTe:MODule:DEFine <nr>,<name>

Parameters: nr → the number of the pressure modules (0 to 9)
name → 9 digit marking of the pressure module

Enquiry form: ROUTe:MODule:DEFine? <nr>

Answer: The marking of the pressure module with the number nr.

REMARKS:

Restrictions: In the following cases the command is not permitted:
- a measurement is started
- the equipment is in the adjustment mode
- the equipment is in the ramp mode

ROUTe:MODule:SERNumber

DESCRIPTION: The serial number of pressure module can be entered or queried.

SYNTAX: ROUTe:MODule:SERNumber <nr>,<sernumb>

Parameters: nr → The number of the pressure modules (0 to 9)
sernumb → 12 digit serial number of the pressure moduls

Enquiry form: ROUTe:MODule:SERNumber? <nr>

Answer: The serial number of the pressure moduls with the number nr

REMARKS:

Restrictions: In the following cases the command is not permitted:
- a measurement is started
- the equipment is in the adjustment mode
- the equipment is in the ramp mode

ROUTe:MODule:SCALE

DESCRIPTION: The scaling values of pressure modulse can be entered or queried.

SYNTAX: ROUTe:MODule:SCALE <nr>,,<pl>,<uh>,<ph>

Parameters: nr → The number of the pressure modules (0 to 9)
Voltage value unlin μ V with pressure pl in adjusted unit.
(Values near zero point)
Voltage value uh in μ V with pressure ph in adjusted unit
(Values near final value)

Enquiry form: ROUTe:MODule:SCALE? <nr>

Answer: ,<pl>,<uh>,<ph>
 Voltage value ul in μV with pressure pl in adjusted unit.
 (Values near zero point)
 Voltage value uh in μV with pressure ph in adjusted unit.
 (Values near final value)

REMARKS:

Restrictions: In the following cases the command is not permitted:
 - a measurement is stated
 - the equipment is in the adjustment mode
 - the equipment is in the ramp mode

ROUTe:MODUle:UNIT

DESCRIPTION: The unit of a pressure module can be entered or queried.

SYNTAX: ROUTe:MODUle:UNIT <nr>,<unit>

Parameters: nr → The number of the pressure modules (0 to 9)
 Unit → A max. 8 digit unit from the associated pressure module

Enquiry form: ROUTe:MODUle:DATE? <nr>

Answer: <unit>
 unit → A max. 8 digit unit from the associated pressure module

REMARKS:

Restrictions: In the following cases the command is not permitted:
 - a measurement is stated
 - the equipment is in the adjustment mode
 - the equipment is in the ramp mode

ROUTe:MODUle:DATE

DESCRIPTION: The calibration date of a pressure module can be entered or queried.

SYNTAX: ROUTe:MODUle:DATE <nr>,<date>

Parameters: nr → The number of the pressure modules (0 to 9)
 Unit → The calibration date from the associated pressure module.
 (8 digit: dd.mm.yy)

Enquiry form: ROUTe:MODUle:DATE? <nr>

Answer: The calibration date from the associated pressure module

REMARKS:

Restrictions: In the following cases the command is not permitted:
 - a measurement is stated
 - the equipment is in the adjustment mode
 - the equipment is in the ramp mode

ROUTe:MODUle:MAXimum

DESCRIPTION: The maximally permitted pressure value of a pressure module can be entered or enquired.

SYNTAX: ROUTe:MODUle:MAXimum <nr>,<maxpressure>

5.2.20 DIAGnostic Subsystem

DIAGnostic:MODule:BATTery:INITiate

DESCRIPTION: The measurement of the battery voltage of an attached pressure module is started.

SYNTAX: DIAGnostic:MODule:BATTery:INITiate

Parameter: No parameters

Enquiry form: non enquiry form

Remarks:

Restrictions: The instruction is only permitted if measure pressure is adjusted (also with simultaneous transmission U/I or measure U/I) and the measurement is not started. With simultaneous transmission and measuring the measured battery voltage is not indicated on the LCD.

DIAGnostic:MODule:BATTery:FETCh?

DESCRIPTION: The measured battery voltage of a pressure module is fetched.

SYNTAX: DIAGnostic:MODule:BATTery:FETCh?

Parameter: No parameters

Enquiry form: Only enquiry form

Answer: The measured battery voltage. Numeric value with unit.

Remarks:

Restrictions: The instruction is only permitted if measure pressure is adjusted (also with simultaneous transmission U/I or measure U/I) or the measurement is not started.

5.2.21 Enquiry of measured values via the DIGISTANT® 4420 interface

INIT starts a continuous measurement.

As soon as a reading is available, it is placed in a buffer and the measurement-available bit is set in the operation status register.

It is therefore possible to find out whether a reading is available by interrogating this register.

If a reading is available, it can be retrieved using the FETCH command.

Using FETCH to retrieve the reading resets the measurement-available bit in the operation status register. This bit is then set again when the next reading is available.

"Abort" stops the measurement.

To ensure that the actual live reading is obtained after restarting the measurement process, it is recommended that in the stopped state, the measurement-available bit in the operation status register is interrogated before starting the measurement, to check whether an old reading is available in the instrument. If the instrument does contain an old reading, then use the FETCH command to retrieve it.

A correct procedure should look like this:

1. Interrogate operation status register to check if reading is available.
2. If so, retrieve it using FETCH
3. Start measurement using INIT
4. Keep interrogating the operation status register until the measurement-available bit is set.
5. Retrieve the reading using FETCH
6. Repeat step 4 and 5 for as long as you wish to obtain readings
7. Stop the measurement using ABORT

5.3. Sample application

```

REM*****
REM
REM Filename   : SCPITEST.bas  Version: 1.1
REM
REM Entwickelt von : CS          am 20.02.1993
REM Geändert von  : MW          am 04.10.1995
REM
REM Sprache     : QBASIC        Betriebssystem: MS-DOS 6.22
REM
REM Funktion    : Mit diesem Testprogramm können SCPI-Befehle über
REM              die RS232 Schnittstelle zu Burster Geräten gesendet
REM              und die Antwort empfangen werden.
REM
REM*****
REM
OPEN „COM1:9600,N,8,1“ FOR RANDOM AS #3 ‘ RS232 INITIALISIEREN
CLS ‘ BILDSCHIRM LÖSCHEN
PRINT „    DEMOPROGRAMM „
PRINT „    burster „
PRINT „Steuerung über RS232 Schnittstelle „
PRINT „Übertragungsprotokoll: ANSI X3.28 A4“
PRINT
PRINT „EXIT mit #“
DIM an$(50)
DIM befehl$(50)
REM Sonderzeichen werden definiert
STX$ = CHR$(2)
etx$ = CHR$(3)
EOTS = CHR$(4)
ENQ$ = CHR$(5)
ACK$ = CHR$(6)
NAK$ = CHR$(21)
CR$ = CHR$(13)
lf$ = CHR$(10)
ESCS = CHR$(27)

select$ = EOTS + „0000SR“ + ENQ$ ‘SELECTION SEQUENZ
polling$ = EOTS + „0000PO“ + ENQ$ ‘POLLING SEQUENZ

WHILE befehl$ <> „#“ ‘Solange keine ESC Taste
LOCATE 10, 1
befehl$ = „“

INPUT „Bitte Befehl eingeben“; befehl$
IF (befehl$ = „“) THEN befehl$ = „fetch?“
query = 0
length = LEN(befehl$)
FOR i = 1 TO length
  IF MID$(befehl$, i, 1) = „?“ THEN
    query = 1
  END IF
NEXT i
LOCATE 19, 1
PRINT „          ”
LOCATE 20, 1
PRINT „          ”
LOCATE 21, 1
PRINT „          ”
LOCATE 22, 1
PRINT „          ”
GOSUB selection
GOSUB SENDBEFEHL
LOCATE 10, 1

```

```

PRINT „
WEND „

CLS          ‘Bildschirm löschen
END          ‘Programm Ende
SYSTEM      ‘Kontrolle an Betriebssystem

SENDBEFEHL: ‘Subroutine Aussenden des Befehls
LOCATE 15, 1
PRINT „
LOCATE 15, 1
PRINT „Gesendeter Befehl: „, befehl$
PRINT #3, STX$ + befehl$ + lf$ + etx$ ‘ Start Befehl senden
ant$ = „    ‘Antwortstring löschen
ant$ = INPUT$(1, #3) ‘Antwort einlesen
LOCATE 17, 1
IF (ant$ <> ACK$) THEN ‘Wenn nicht ACK
  PRINT „Gerät antwortet mit NAK „ ‘Fehlermeldung anzeigen
ELSE ‘ansonsten
  PRINT „ „ ‘wurde Befehl verstanden
END IF
IF query = 1 THEN GOSUB getpar
RETURN

getpar:      ‘Subroutine zum Abholen eines Parameters
GOSUB polling
mk1:
  ant$ = „    ‘Antwortstring löschen
  stri$ = „    ‘Messwertstring löschen
  ant$ = INPUT$(1, #3)

  WHILE (ant$ <> etx$) AND (ant$ <> EOT$) ‘Solange kein ETX und EOT empfangen
  IF ant$ >= CHR$(32) THEN ‘ Wenn keine Sonderzeichen
    stri$ = stri$ + ant$ ‘Messwertstring bilden
  END IF
  ant$ = INPUT$(1, #3) ‘Zeichen von RS232 einlesen
WEND

IF (ant$ = EOT$) THEN ‘Wenn EOT empfangen
  LOCATE 22, 10 ‘Zeile 18, Spalte 1
  PRINT „Kein weiterer Parameter“ ‘Meldung anzeigen

ELSE
  LOCATE 19, 1 ‘Zeile 20, Spalte 1
  PRINT „Empfangener Parameter: „, stri$ ‘Empfangener Messwert anzeigen
  PRINT #3, ACK$
  GOTO mk1
END IF

RETURN

selection:  ‘Subroutine für Selection
PRINT #3, select$ ‘Selection With Response übertragen
ant$ = „    ‘Antwortstring löschen
ant$ = INPUT$(1, #3) ‘Antwort abholen
LOCATE 12, 1
PRINT „
IF (ant$ <> ACK$) THEN ‘Wenn nicht ACK
  LOCATE 12, 1 ‘Zeile 12, Spalte 1
  PRINT „Selection nicht erkannt“ ‘Fehlermeldung anzeigen
END IF
RETURN

polling:    ‘Subroutine für Polling
PRINT #3, polling$ ‘Polling Sequenz übertragen
RETURN

```

6. Maintenance and customer service

6.1 Maintenance

In principle, the DIGISTANT® does not require any maintenance by the user. Any necessary repairs must only be performed by the manufacturer.

6.2 Customer service

Inquiries

We strongly recommend that technical inquiries to the manufacturer be accompanied by the serial number of the device in question, as this will allow a determination of the technological version (including the software release) so that rapid assistance can be provided. The serial number is inscribed on the type plate.

Shipping instructions

When sending the DIGISTANT® in for repairs, please observe the following packaging and shipping guidelines:

Complaints regarding the device should be described using keywords on a slip of paper which is to be attached to the housing of the device.

We will be able to process your complaints faster if you add your name, department, fax number and telephone number in case we need to make any checks with you.

burster präzisionsmesstechnik gmbh & co kg

Talstr. 1-7

DE-76593 Gernsbach

P.O.Box 1432

DE-76587 Gernsbach

Tel.: +49-7224-6450

Fax: +49-7224-64588

6.3 Manufacturer's guarantee

burster guarantees reliable operation of the device for a period of 12 months following delivery.

All repairs required within this period will be performed free-of-charge.

Damage caused through improper handling of the device is not covered by the guarantee.

The technical data is subject to alterations without notice at any time.

6.4 Cleaning

Clean the front panel and housing with water-soluble detergents; do not use benzols.

6.5 Handling batteries

Auxiliary power is supplied by an integrated Ni-MH accumulator.

This accumulator is fully protected against overload and deep discharge.

However, should it become necessary to replace the accumulator, send the DIGISTANT® in for repair!

In this case, the device will also be given a complete checkover and recalibrated, if required.

The replacement will consist of a 6 V/4.4 Ah accumulator block bearing a recycling symbol (ISO 7000 Reg No. 1135) which characterizes environmentally-compatible batteries.

If you want to replace the accumulator yourself and cannot dispose of it correctly, please send it back to us.

7. Technical data

7.1 Measure and source

Technical Data

Voltage Measurement Instruments							
Range	Resolution	R _E	I _E	Zero Drift	TC	Zero Error	Tolerance
± 9.999 mV	1 µV	> 1 GΩ	< 20 nA	< 0.8 µV/K	30 ppm/K	≤ 7 µV	0.035 % of range
± 99.99 mV	10 µV	> 1 GΩ	< 20 nA	< 1.5 µV/K	30 ppm/K	≤ 15 µV	0.025 % of range
± 999.9 mV	100 µV	> 1 GΩ	< 20 nA	< 7 µV/K	30 ppm/K	≤ 100 µV	0.025 % of range
± 12.000 V	1 mV	> 1 GΩ	< 20 nA	< 7 µV/K	30 ppm/K	≤ 1mV	0.025 % of range

Voltage Source							
Range	Resolution	R _I	Zero Drift	TC	Zero Error	Tolerance	
0.000 mV to ± 9.999 mV	1 µV	< 5 mΩ	0.5 µV/K	30 ppm/K	< 5 µV	0.02 % of range	
± 10.00 mV to ± 99.99 mV	10 µV	< 5 mΩ	0.8 µV/K	30 ppm/K	< 8 µV	0.015 % of range	
± 100.0 mV to ± 999.9 mV	100 µV	< 5 mΩ	1 µV/K	30 ppm/K	< 80 µV	0.015 % of range	
± 1.000 V to ± 11.000 V	1 mV	< 5 mΩ	3 µV/K	30 ppm/K	< 0.8 mV	0.015 % of range	

Current Measuring Instruments						
Range	Resolution	R _E	Zero Drift	TC	Zero Error	Tolerance
± 30.000 mA	1 µA	< 10 Ω	0.5 µA/K	40 ppm/K	≤ 3 µA	0.025 % v.E.

Current Source							
Range	Resolution	R _I	Zero Drift	TC	Zero Error	Tolerance	
0.0000 mA to ± 1.9999 mA	100 nA	> 100 MΩ	40 nA/K	40 ppm/K	< 500 nA	0.02 % of range	
± 2.000 mA to ± 22.000 mA	1 µA	> 100 MΩ	80 nA/K	40 ppm/K	< 1.6 µA	0.015 % of range	

Resistance Measuring Range				
Range	Resolution	Source	Accuracy	TC
0.00 Ω to 200.00 Ω	0.01 Ω	0.6 mA	< 0.04 Ω	50 ppm/K
200.0 Ω to 2000.0 Ω	0.1 Ω	0.6 mA	< 0.4 Ω	50 ppm/K

Resistance Simulator						
Range	Resolution	Source	Zero Drift	TC	Zero Error	Tolerance
10.00 Ω to 399.99 Ω	0.02 Ω	150 µA - 2.5 mA	3 µV/K/Imess	60 ppm/K	< 40 mΩ	0.025 % of range
400.0 Ω to 4000.0 Ω	0.2 Ω	50 µA - 2.5 mA	5 µV/K/Imess	60 ppm/K	< 400 mΩ	0.025 % of range

Temperature Measuring / Thermocouples / Thermocouples Simulator						
Model	Thermocouples	Standard Specification	Range	Accuracy Simulating	Accuracy Measuring	
R	PtRh 13 - Pt	EN 60584-1 / ITS 90	- 50.0 °C ... +1767.9 °C	1.0 K	1.4 K (+150 ... 953 °C)	
S	PtRh 10 - Pt	EN 60584-1 / ITS 90	- 49.8 °C ... +1767.8 °C	0.9 K	1.4 K (+200 ... 1027 °C)	
B	PtRh 30 - PtRh 6	EN 60584-1 / ITS 90	+ 99.2 °C ... +1820.0 °C	1.0 K	1.4 K (+850 ... 1482 °C)	
J	Fe - CuNi	EN 60584-1 / ITS 90	-210.0 °C ... +1200.0 °C	0.4 K	0.7 K (-210 ... 1200 °C)	
T	Cu - CuNi	EN 60584-1 / ITS 90	-269.4 °C ... + 400.0 °C	0.5 K	0.7 K (-200 ... 400 °C)	
E	NiCr - CuNi	EN 60584-1 / ITS 90	-269.5 °C ... +1000.0 °C	0.4 K	0.6 K (-220 ... 1000 °C)	
K	NiCr - NiAl	EN 60584-1 / ITS 90	-269.1 °C ... +1372.0 °C	0.5 K	0.7 K (-200 ... + 243 °C)	
U	Cu - CuNi	DIN 43710 / IPTS 68	-199.9 °C ... + 599.9 °C	0.6 K	0.7 K (-150 ... + 213 °C)	
L	Fe - CuNi	DIN 43710 / IPTS 68	-199.9 °C ... + 899.9 °C	0.3 K	0.4 K (-100 ... + 181 °C)	
N	NiCrSi - NiSi	EN 60584-1 / ITS 90	-270.0 °C ... +1299.9 °C	0.5 K	0.7 K (-150 ... 315 °C)	
M	NiMo 18 - Ni	General Electric IPTS 68	0.0 °C ... +1400.0 °C	0.5 K	0.9 K (0 ... 1400 °C)	
C	W5Re - W26Re	Hoskins ITS 90	0.0 °C ... +2314.9 °C	0.6 K	0.8 K (0 ... 563 °C)	
D	W3Re - W25Re	Hoskins ITS 90	0.0 °C ... +2315.0 °C	0.5 K	0.7 K (+200 ... 590 °C)	
G2	W - W26Re	Hoskins ITS 90	0.0 °C ... +2315.0 °C	0.9 K	1.3 K (+200 ... 780 °C)	

The EN 60584-1 / ITS 90 standard is equivalent to NIST 175 and IEC 584-1: 1995
 Accuracy without deviation. Accuracy is referred to definition of characteristic curve. (Valid for RJ-Man 0 °C)
 * Error of reference junction: internal 0.4 K external with 4485-V001 0.3 K additional

Temperature Measuring / RTD Simulator [Pt-DIN EN 60751 // Ni-DIN 43760; IPTS 68]											
Pt100			Pt200			Pt500			Pt1000		
Range	Tolerance		Range	Tolerance		Range	Tolerance		Range	Tolerance	
	Simulating	Measuring		Simulating	Measuring		Simulating	Measuring		Simulating	Measuring
-200 ... 266.3°C	0.3 K	0.08 K	200 ... - 0.1 °C	0.15 K	0.06 K	-200 ... -149.4 °C	0.05 K	0.03 K	- 200 ... + 260 °C	0.3 K	0.15 K
267 ... 849 °C	0.3 K	0.8 K	0 ... 266.3 °C	0.15 K	-	-149.5 ... - 50.8 °C	0.05 K	-	+ 260 ... + 849 °C	0.3 K	-
			0 ... 849 °C	-	0.7 K	- 51 ... +849 °C	0.7 K	-			
			267 ... 849 °C	1.8 K	-	-149.5 ... +849 °C	-	0.3 K			
Ni100			Storage temperature: - 10 ... 60 °C								
Range			Charging temperature: 10 ... 23 ... 35 °C								
Tolerance			Power supply:								
Simulating			a.) NiMH accumulator, firmly fitted operating period 7 - 10 hours								
Measuring			b.) 230 V AC + 6 %, - 10 %, 50 - 60 Hz (115 V upon request)								
- 60 ... + 249 °C	0.25 K	0.08K	Protection: IP 50								

The radio interference suppression class B according to VDE 0871 is only observed in connection with the standard power supply burster model 4495-V001.

Long-term stability: < 25 ppm/month

Environment

Operating temperature range: 0 ... 23 ... 50 °C
 0 ... 70 % humidity, non -condensing

RS232 interface

Opto-isolated, baudrate 600-19200 all functions can be fully controlled and configured via the RS232 interface, 3-pin jack bush, protocol ANSI X. 3.28 subcategory 2.5, A3/A4, language SCPI, version 1993.0

Housing

Aluminium housing, desk-shaped, side covers made of plastic material
 Dimensions (W x H x D): 235 x 85 x 175 [mm]
 Weight: 2.5 kg

7.2 Interference-suppression class

The interference-suppression class B specified by the VDE (Association of German Electrical Engineers) standard 0871 is only adhered to in conjunction with the burster type 4495-V001 power supply unit.

7.3 Long-term stability

Long-term stability: < 25 ppm/month

7.4 Influencing variables

Operating temperature range:	0 ... <u>23</u> ... 50 °C, 0 ... 70 % humidity, non-condensing
Storage temperature	-10 ... 60 °C
Charging temperature:	10 ... <u>23</u> ... 35 °C
Power supply:	
a. Ni-MH-battery, firmly fitted	operating period
b. 230 V AC + 6 %, - 10 %, 50 - 60 Hz	(115 V upon request)
Protection:	IP 50

7.5 Interface (RS232)

Opto-insulated, 600-19200 Baud all functions can be fully controlled and configured via the RS232 interface, 3-pinjack bush, protocol ANSI X. 3.28 subcategory 2.5, A3/A4, language: SCPI, Version: 1993.0.

7.6 Housing

Aluminium housing, desk-type design, with plastic edges

Dimensions [W x H x D]: 235 x 85 x 175 [mm]

Weight: 2.5 kg