

# optris® CT LT

Precise non-contact temperature measurement from -50°C to 975°C



## FEATURES

- One of the smallest infrared sensors worldwide with 22:1 optical resolution
- Rugged and usable up to 180°C ambient temperature without cooling
- Separate electronics with easy accessible programming keys and LCD backlit display
- Selectable analog output: 0/4-20 mA, 0-5 V, 0-10 V, thermocouple type K or J
- Optional USB, RS485, RS232 interface, relay outputs (2 x optically isolated), CAN-Bus, Profibus DP, Ethernet
- Installation of up to 32 sensing heads
- CTex: Explosion proof version (ATEX) 

### General Specifications

Environmental rating	IP 65 (NEMA-4)
Ambient temperature	-20°C to 180°C (130°C at LT02) (sensing head) 0°C to 85°C (electronics)
Storage temperature	sensing head: -40 to 180°C (130°C at LT02) electronics: -20°C to 85°C
Relative humidity	10 - 95%, non condensing
Vibration (sensor)	IEC 68-2-6: 3 G, 11-200 Hz, any axis
Shock (sensor)	IEC 68-2-27: 50 G, 11 ms, any axis
Weight	sensing head 40 g electronics 420 g

### Electrical Specifications

Outputs/analog	channel 1: 0/4 - 20 mA, 0-5/10 V, thermocouple J, K channel 2: sensind head temperature (-20°C - 180°C as 0-5 V or 0-10 V), alarm output
Output/alarm	24 V/50 mA (open collector)
Optional	relay: 2 x 60 V DC/42 V AC <sub>eff</sub> : 0.4 A; optically isolated
Outputs/digital (optional)	USB, RS232, RS485 (optional), CAN-Bus, Profibus DP, Ethernet
Output impedances	mA max. 500 Ω (with 8-36 V DC) mV min. 100 kΩ load impedance thermocouple 20 Ω
Inputs	programmable functional inputs for external emissivity adjustment, ambient temperature compensation, trigger (reset of hold functions)
Cable length	1 m (standard), 3 m, 8 m, 15 m
Current draw	max. 100 mA
Power Supply	8-36 V DC

### Measurement Specifications

Temperature range (scalable via programming keys or software)	-50°C to 975°C (LT22) -50°C to 600°C (LT15) -50°C to 600°C (LT02)
Spectral range	8-14 μm
Optical resolution (90% energy)	22:1 (precision glass optics) 15:1 (precision glass optics) 2:1 (with flat front window)
CF-lens (optional)	0.6 mm @ 10 mm (LT22) 0.8 mm @ 10 mm (LT15) 2.5 mm @ 23 mm (LT02)
System accuracy <sup>1),2)</sup> (at ambient temp. 23 ±5°C)	± 1% or ± 1°C
Repeatability <sup>1),2)</sup> (at ambient temp. 23 ±5°C)	± 0.5% or ± 0.5°C
Temperature resolution (display)	0.1°C
NETD <sup>2),3)</sup>	0.05 K (LT22/LT15) 0.1 K (LT02)
Response time	150 ms (95 %)
Emissivity/Gain (adjustable via programming keys or software)	0.100 - 1.100
Transmissivity/Gain (adjustable via programming keys or software)	0.100 - 1.100
Signal processing (parameter adjustable via programming keys or software, respectively)	peak hold, valley hold, average; extended hold function with threshold and hysteresis
Software	optris Compact Connect

<sup>1)</sup> whichever is greater

<sup>2)</sup> at object temperatures > 0°C, ε = 1

<sup>3)</sup> at time constant 200 ms and T<sub>obj</sub> 25°C

## Optical Specifications

Optics CT LT SF, D:S = 2:1

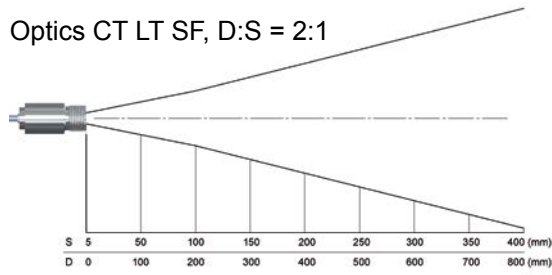

Optics CT LT CF, D:S = 2:1 (far field = 2,5:1)

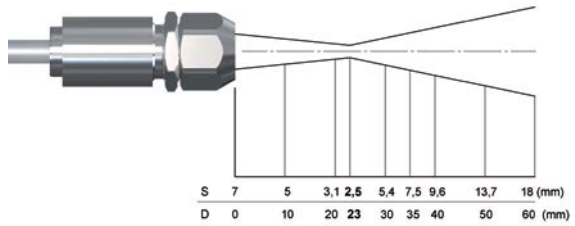

Optics CT LT SF, D:S = 15:1

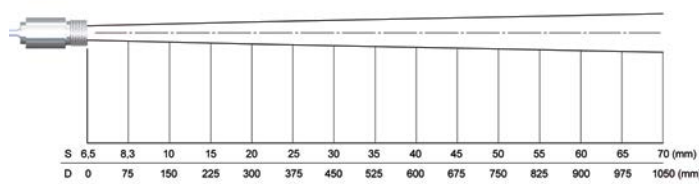

Optics CT LT CF, D:S = 15:1 (far field = 1,5:1)

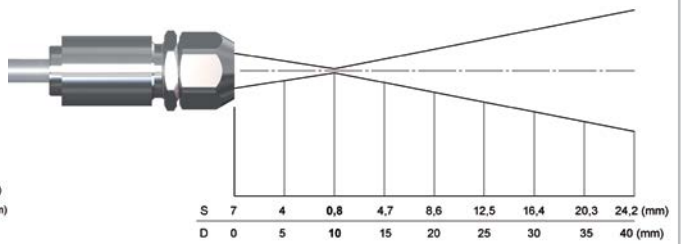

Optics CT LT SF, D:S = 22:1

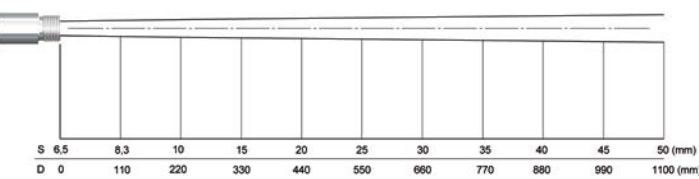

Optics CT LT CF, D:S = 22:1 (far field = 1,5:1)

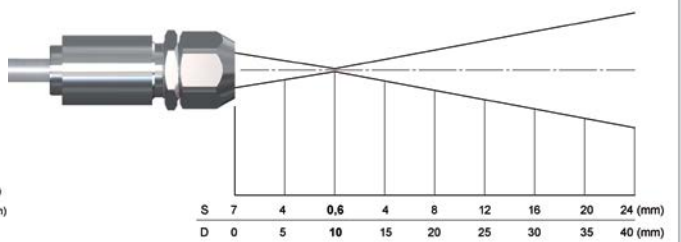

## Versions with built-in CF lenses

Optics CT LT CF, D:S = 15:1 (far field = 5:1)

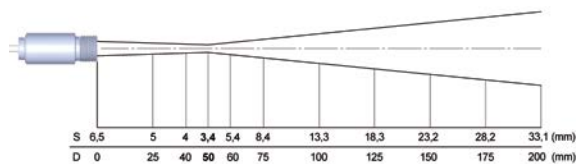

Optics CT LT CF, D:S = 22:1 (far field = 6:1)

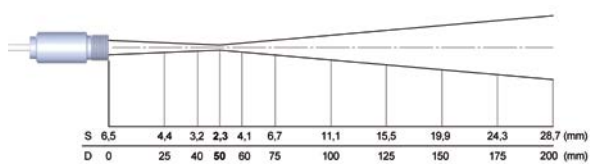

## Dimensions

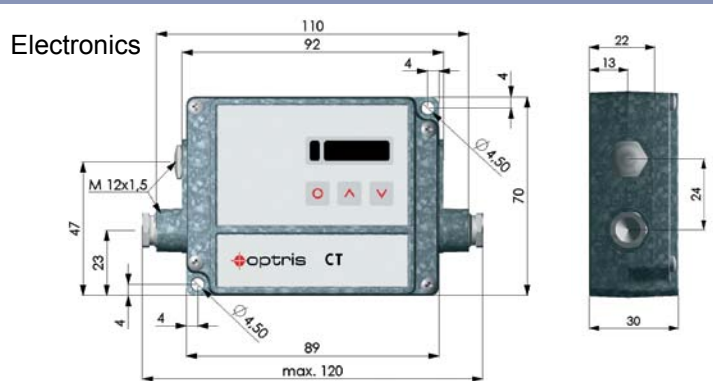
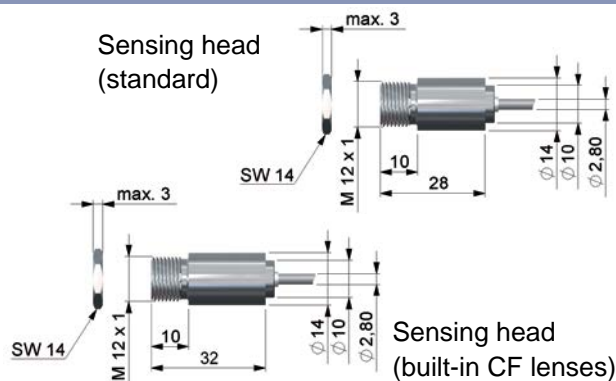

Specifications are subject to change without notice  
CTLT-DS-E2014-05-A