

# NETZTEIL POWER SUPPLY UNIT T24

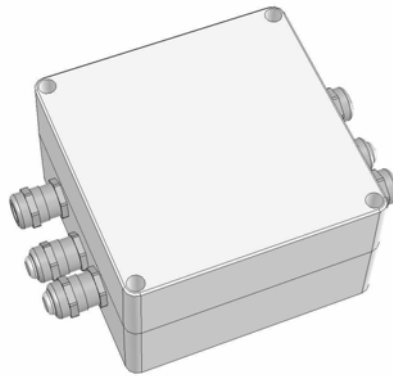

## Bedienungsanleitung Operation Instructions

95583016  
05/10/09 de



**Messtechnik Schaffhausen GmbH**

Mühlenstrasse 4, CH-8260 Stein am Rhein

Telefon +41 52-672 50 00

Telefax +41 52-672 50 01

www.mts.ch, e-mail: info@mts.ch

Messen Prüfen Automatisieren [www.mts.ch](http://www.mts.ch)

Weitergabe sowie Vervielfältigung dieser Unterlage, Verwertung und Mitteilung ihres Inhalts nicht gestattet, soweit nicht ausdrücklich zugestanden.

Zuwiderhandlungen verpflichten zu Schadenersatz. Alle Rechte vorbehalten, insbesondere für den Fall der Patenterteilung oder GM-Eintragung.

(c) HEITRONICS Infrarot Messtechnik GmbH

*The reproduction, transmission or use of this document or its contents is not permitted without express written authority.*

*Offenders will be liable for damages. All rights, including rights created by patent grant or registration of a utility model or design, are reserved.*

(c) HEITRONICS Infrarot Messtechnik GmbH

**HEITRONICS**

Infrarot Messtechnik GmbH

Kreuzberger Ring 40

65205 Wiesbaden

Tel.: +49 (0)611 973930

Fax: +49 (0)611 9739326

E-Mail: info@heitronics.com

Internet: www.heitronics.com

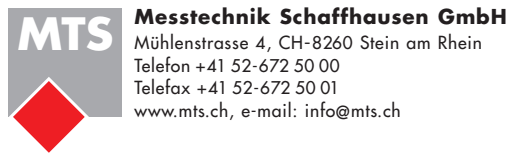

**Messtechnik Schaffhausen GmbH**

Mühlenstrasse 4, CH-8260 Stein am Rhein

Telefon +41 52-672 50 00

Telefax +41 52-672 50 01

[www.mts.ch](http://www.mts.ch), e-mail: [info@mts.ch](mailto:info@mts.ch)

**Messen Prüfen Automatisieren [www.mts.ch](http://www.mts.ch)**

# INHALT / CONTENTS LIST

<b>Bestimmungsgemäße Verwendung / Intended Use</b> .....	<b>3</b>
<b>Sicherheitshinweise / Safety Instructions</b> .....	<b>4</b>
<b>Technische Daten / Technical Data</b> .....	<b>6</b>
<b>Elektrische Daten / Electrical Data</b> .....	<b>6</b>
<b>Gehäusedaten / Housing Data</b> .....	<b>6</b>
<b>Konformitätserklärung / Declaration of Conformity</b> .....	<b>7</b>
<b>Aufbau / Design</b> .....	<b>8</b>
<b>Einrichten / Setup</b> .....	<b>8</b>
<b>Wartung / Maintenance</b> .....	<b>8</b>
<b>Anschlüsse / Connections</b>	
Übersicht / Overview .....	9
Anschluss Pyrometer / Connection Pyrometer .....	9
Anschluss Host / Connection HOST .....	10
Anschluss Netzspannung / Connection Supply Voltage .....	10
Anschluss PT 100 / Connection PT 100 .....	11
Anschluss Thermoelement / Connection Thermocouple .....	11
Anschluss RS422 / Connection RS422 .....	12
Anschluss KT15II / Connection KT15II	
Options: Thermo switch.....	13
Digital input .....	13
Analog input.....	14
Isulated output .....	14
Isulated input and output.....	15
Isulated 2 outputs.....	15
Anschluss KT19II / Connection KT19II	
Options: 2 Relais .....	16
1 Relais + ext. ambient .....	16
Anschluss LS12 / Connection LS12	
Options: Use RS232 only .....	17
Use analog output only .....	18
Use RS232 and analog output.....	19
Anschluss CT13 / Connection CT13	
Options: 2 x digital output.....	20
Digital input and output .....	21

Anschluss CT09 / Connection CT09	
<i>Options:</i> Digital input .....	22
Digital output .....	23
Anschluss CT08 / Connection CT08	
<i>Options:</i> Digital input .....	24
Digital output .....	25
Anschluss KTX / Connection KTX .....	26
Anschluss KT18R / Connection KT18R .....	27
<b>Kompatibilitätsliste / Compatibility list .....</b>	<b>28</b>
<b>Belegung HEITRONICS Schnittstellenkabel / Assignment Interface-cable .....</b>	<b>29</b>
<b>Jumperpositionen / Position of Jumpers .....</b>	<b>30</b>
<b>Schaltplan / Wiring Diagram .....</b>	<b>31</b>
<b>Service .....</b>	<b>32</b>

# NETZTEIL POWER SUPPLY UNIT T24



## Bestimmungsgemäße Verwendung / *Intended Use*

Das T24 dient als Versorgung eines Strahlungspyrometers und dessen Zubehör.  
Das Gerät erzeugt eine Schutzkleinspannung von 24 VDC.  
Es wird an ein Wechselstromnetz von 90 bis 264 VAC angeschlossen.  
Alternativ: Gleichspannung 120 bis 370 VDC (siehe Daten).  
Ein Schutzleiter wird nicht angeschlossen.

Es besteht die Möglichkeit eine Funktionserde anzuschließen.

*The T24 serves as supply of an IR Radiation Pyrometer and its accessories.  
The equipment produces a safety-low voltage of 24 VDC.  
It is connected to an AC network from 90 to 264 VAC.  
Alternatively: DC voltage 120 to 370 VDC (see data).  
A protective conductor is not connected.*

*It is possible to connect a function earth.*



## Sicherheitshinweise

Bitte beachten sie die Sicherheitshinweise, insbesondere die Anschluss- und Betriebsbedingungen.

### ACHTUNG

Bei Falschanschluss kann das  
Gerät zerstört werden.

Vor dem Öffnen des Gerätes Netzstecker ziehen. Wenn das Gerät fest installiert ist, vorher spannungsfrei schalten.

Beim Anklemmen der Wechselspannungsleitung ist darauf zu achten, dass die einzelnen Adern nicht länger als 8 mm abisoliert werden. Diese beiden Adern müssen kurz vor der Anschlussklemme mit einem Kabelbinder zusammengebunden werden.

Die Schutzart IP 66/67 gilt nur, wenn die Kabelverschraubungen fachgerecht montiert sind und das Gehäuse richtig zugeschraubt ist. Im Betrieb kann sich das Gehäuse leicht erwärmen.



## Safety Instructions

Please read carefully the safety instructions in particular the connecting and operating conditions.

### ATTENTION

*In case of wrong connection,  
the device might be destroyed.*

*Unplug power supply before opening the equipment. In case the equipment is firmly installed, switch zero potential.*

*When attaching the AC line make certain that the individual wires are not stripped longer than 8 mm. These two wires must be tied together with a cable strap curtly before the connecting terminal.*

*The type of protection IP 66/67 is only valid, if the cable glands are professionally installed and the housing is correctly screwed on. In operation the housing can warm up easily.*



## Technische Daten / *Technical Data*

### Elektrische Daten / *Electrical Data*

Ausgangsspannung / <i>output voltage</i> :	24 VDC, 400 mA
Versorgungsspannung / <i>supply voltage</i> :	90 ... 264 VAC
Netzfrequenz / <i>supply frequency</i> :	47 ... 440 Hz
Versorgungsspannung / <i>supply voltage</i> :	120 ... 370 VDC
Kurzschlussicherheit / <i>short-circuit proof</i> :	dauernd, autom. Neustart <i>continuous, auto restart</i>
Betriebstemperatur / <i>operating temperature</i> :	-25 ... +40 °C

### Gehäusedaten / *Housing Data*

Abmessungen / <i>dimensions</i> :	122 mm x 120 mm x 75 mm
Material / <i>material</i> :	Polycarbonat / <i>polycarbonate</i>
Schutzart (EN 60529) / <i>protection class</i> :	P 66/67
Schlagfestigkeit (EN 62262) / <i>resistance to shock</i> :	IK08/07

**Konformitätserklärung**  
**Declaration of Conformity**

**Netzteil / Power Supply Unit**

**T24**

**HEITRONICS Infrarotmesstechnik GmbH**  
**Kreuzberger Ring 40**  
**65205 Wiesbaden**  
**Germany**

Das oben genannte Produkt ist entwickelt, konstruiert und gefertigt in  
Übereinstimmung mit folgenden EG-Richtlinien:  
*The product specified above is developed, designed and manufactured in agreement  
with the following EC directives:*

EMV-Richtlinie / EMC directive 2004/108/EG  
Niederspannungsrichtlinien / Low-voltage directive 2006/95/EG

**Angewendete harmonisierte Normen / Applied harmonized standards:**

EN 61010:2005 Einrichtungen der Informationstechnik: elektrische Sicherheit  
*Equipment of information technology: electrical security*  
EN 55022 Einrichtungen der Informationstechnik: Funkstöreigenschaften  
*Equipment of information technology: radio interference*  
EN 55024 Einrichtungen der Informationstechnik:  
Störfestigkeitseigenschaften  
*Equipment of information technology: noise immunity*

Eine technische Dokumentation im Sinne der Richtlinie ist vorhanden.  
Die entsprechende Bedienungsanleitung liegt vor.  
Die Sicherheits- und Betriebshinweise der mitgelieferten  
Produktdokumentation sind zu beachten.

*A technical documentation in the sense of the guideline is available.  
The appropriate operating instructions are available.  
Please note the safety and the operating instructions  
of the provided product documentation.*

Wiesbaden, 08. Juli 2009

Ort / Location

Datum / Date

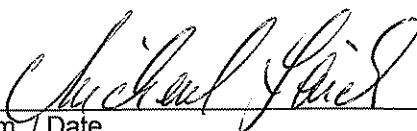

Unterschrift / Signature

## **Aufbau / Design**

Das Gerät bietet die Möglichkeit, die Anschlussleitungen eines Pyrometers komplett aufzulegen und die verschiedenen Funktionen in unterschiedlichen Leitungen zu verteilen. So ist es z.B. möglich, Analogausgang und Schnittstelle getrennt voneinander in unterschiedlichen Kabeln weiterzuleiten.

Optionen:

Es ist möglich einen RS232 zu RS422 Wandler zu bestücken, um größere Leitungslängen zu überwinden.

Der Einbau eines Pt100 oder eines Thermoelementwandlers ermöglicht es, einen Pt100 oder Thermoelement anzuschließen und dessen Signal als Umgebungstemperatur dem Pyrometer zuzuführen.

Eine 12VDC Hilfsspannung kann zur Verfügung gestellt werden.

Alle Komponenten werden vom eingebauten Netzteil gespeist.

Der Einbau eines Tasters ermöglicht es beispielsweise, den Laser im Pyrometer einzuschalten.

*The equipment provides the possibility to connect the complete wiring cable of a pyrometer and to distribute the different functions in different wires. So e.g. it is possible to pass on analogue output and interface -separated from each other- in different cables.*

Options:

*It is possible to implement a RS232 to RS422 converter, in order to surmount larger cable lengths.*

*The installation of a Pt100 or a thermocouple converter allows to connect a Pt100 or a thermocouple and to supply its signal to the pyrometer as ambient temperature.*

*A 12VDC auxiliary supply can be provided.*

*All components are fed by the built-in charger.*

*The installation of a pushbutton enables for example to switch the laser on in the pyrometer.*

## **Einrichten / Setup**

Das Gerät kann mit einem Netzkabel als ortsunabhängige Stromversorgung für ein Pyrometer verwendet werden. Es kann auch fest installiert als lokale Stromversorgung und Signalverteilung in einer Maschine dienen.

*The equipment can be used with a mains cable as stand-alone power supply for a pyrometer. Firmly installed it can serve also as local power supply and signal distribution in a machine.*

## **Wartung / Maintenance**

Das Gerät ist wartungsfrei. Lediglich sollte ab und zu das Gehäuse auf Beschädigungen geprüft werden, um die Dichtigkeit zu gewährleisten.

*The equipment is maintenance-free. Only the housing should be examined for damages from time to time, in order to ensure the tightness.*

# Anschlüsse / Connections

## Übersicht / Overview

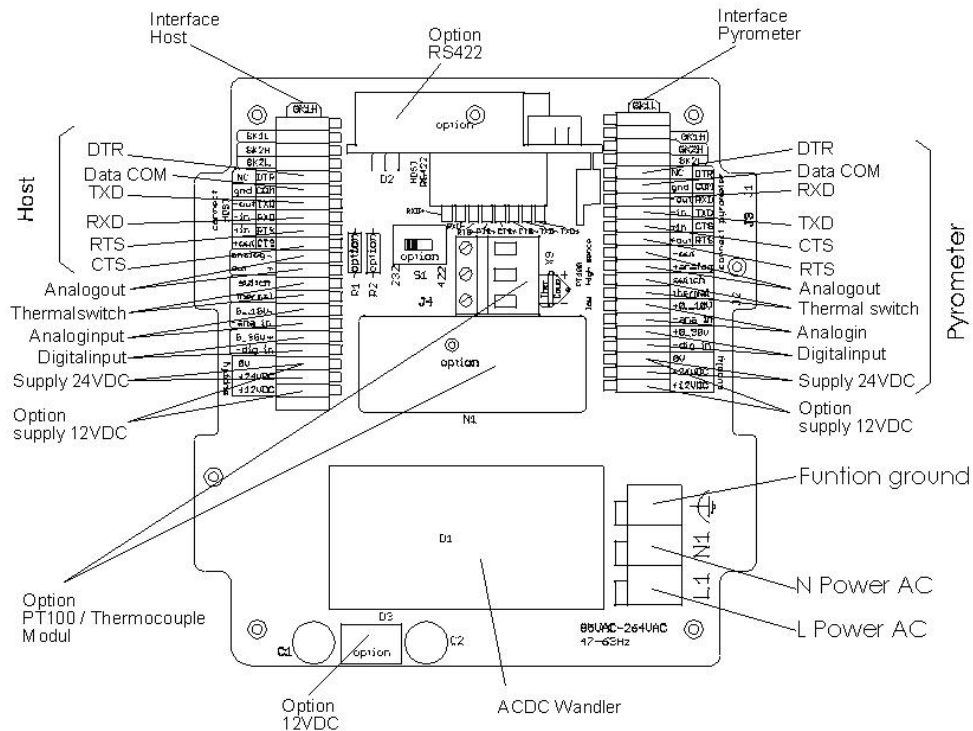

## Anschluss Pyrometer / Connection Pyrometer

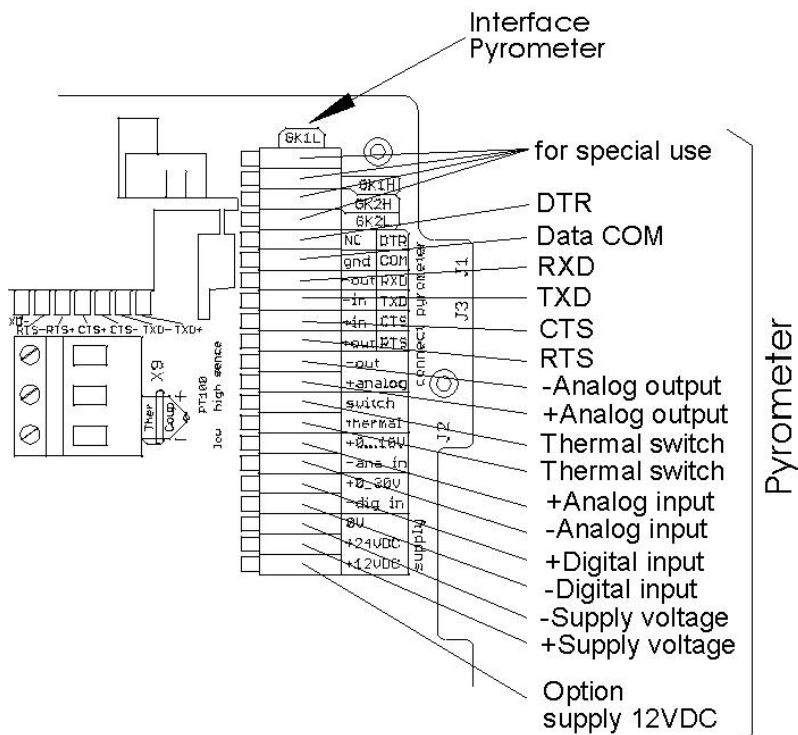

## Anschluss Host / Connection HOST

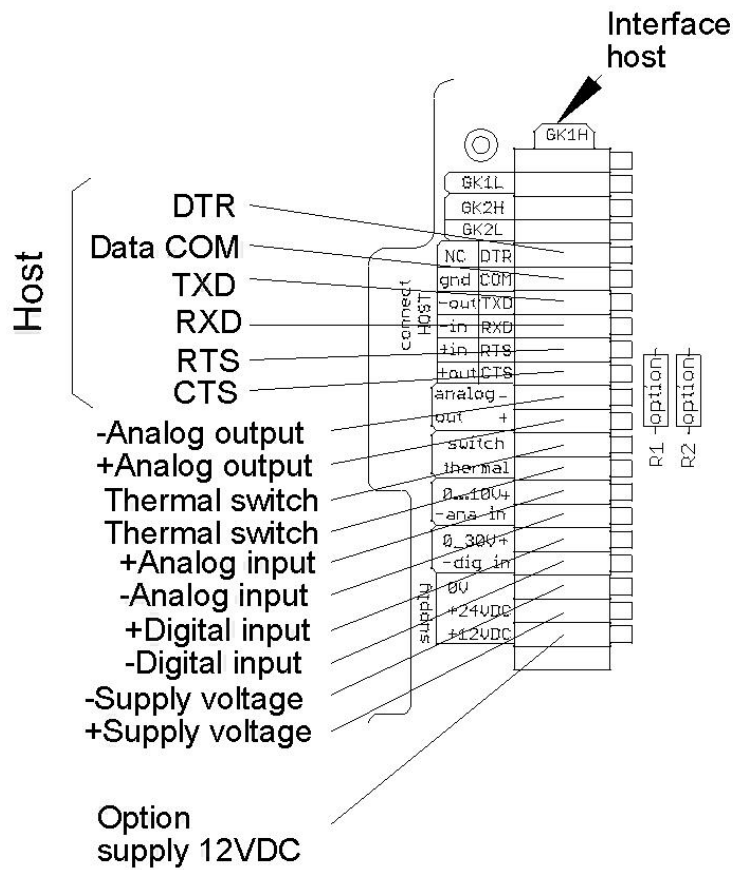

## Anschluss Netzspannung / Connection Supply Voltage

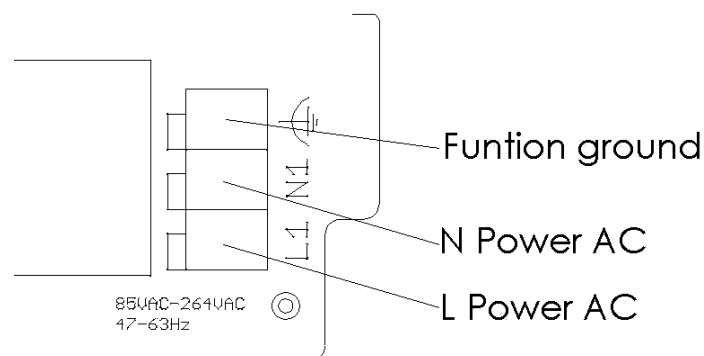

## Anschluss PT 100 / Connection PT 100

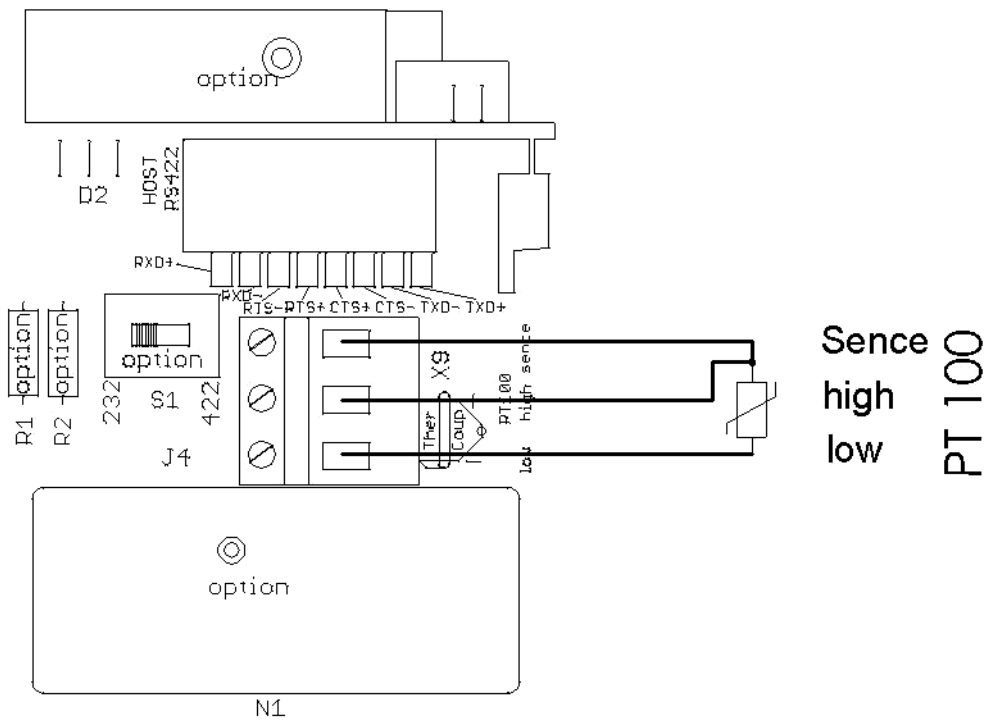

## Anschluss Thermoelement / Connection Thermocouple

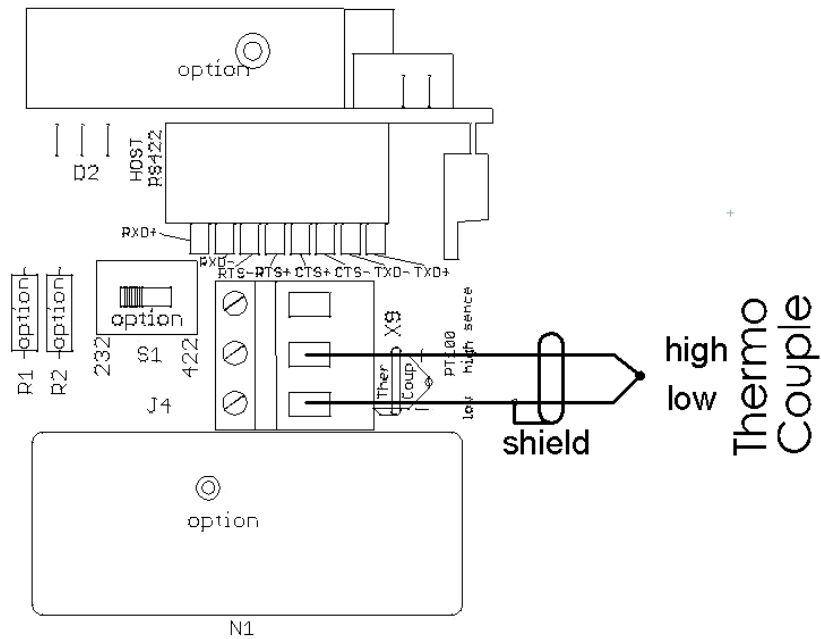



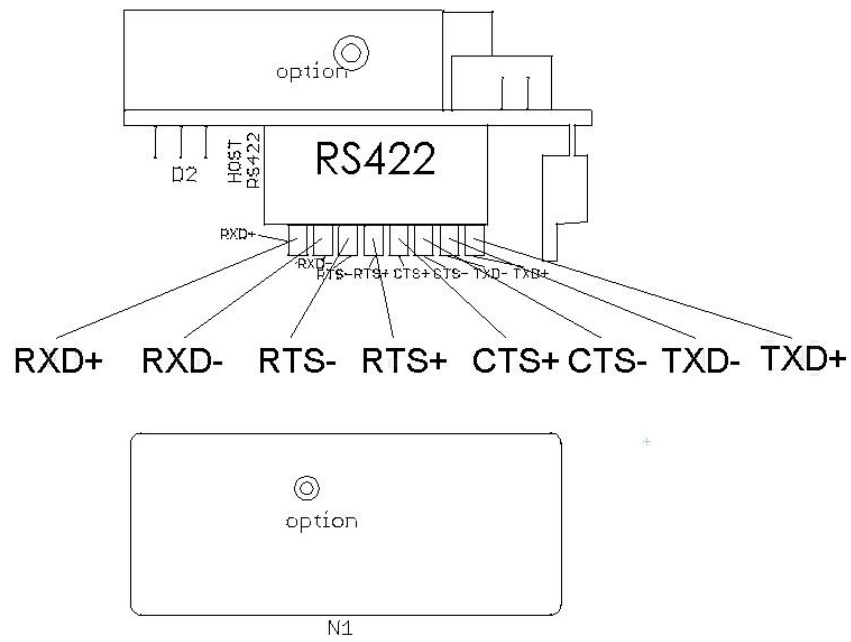

## Anschluss RS422 / Connection RS422







## Anschluss KT15II / Connection KT15II



T24 			cable	KT15II standard 	
Interface host		Interface Pyrometer		option analog input	Interface cable colour
GK1L		GK1L			
GK1H		GK1H			
Gk2H		Gk2H			
GK2L		GK2L			
DTR	◀	DTR	◀	BNWH / RDBU / OR	
COM	◀	COM	◀	BK	
RXD	◀	RXD	◀	BU	
TXD	◀	TXD	◀	PK	
CTS	◀	CTS	◀	RD	
RTS	◀	RTS	◀	VT	
-out	◀	-out	◀	GN	
+analog switch	◀	+analog switch	◀	YE	
thermal		thermal			
+0...10V	◀	+0...10V	◀	GNWH / GYPK / colorless	
-ana in	◀	-ana in	◀	GY	
+0...30V		+0...30V			
-dig in		-dig in			
0V	supply	0V	◀	WH	
+24VDC	supply	+24VDC	◀	BN	
+12VDC		+12VDC			

T24 			cable	KT15II option 	
Interface host		Interface Pyrometer		isolated output	Interface cable colour
GK1L = isolated com	◀	GK1L	◀	GY	
GK1H = isolated open collector DO	◀	GK1H	◀	BNWH / RDBU / OR	
Gk2H = isolated open collector DO2 / DI	◀	Gk2H	◀	GNWH / GYPK / colorless	
GK2L = isolated com*		GK2L			
DTR		DTR			
COM	◀	COM	◀	BK	
TXD	◀	RXD	◀	BU	
RXD	◀	TXD	◀	PK	
RTS	◀	CTS	◀	RD	
CTS	◀	RTS	◀	VT	
-out	◀	-out	◀	GN	
+analog switch	◀	+analog switch	◀	YE	
thermal		thermal			
+0...10V		+0...10V			
-ana in		-ana in			
+0...30V		+0...30V			
-dig in		-dig in			
0V	supply	0V	◀	WH	
+24VDC	supply	+24VDC	◀	BN	
+12VDC		+12VDC			



\* J1 closed



## Anschluss KT15II / Connection KT15II

T24 			cable	KT15II option 
Interface host		Interface Pyrometer		isolated input and output
				Interface cable colour
GK1L = isolated com	◀	GK1L	◀	GY
GK1H = isolated open collector DO	◀	GK1H	◀	BNWH / RDBU / OR
GK2H = isolated open collector DO2 / DI	◀	GK2H	◀	GNWH / GYPK / colorless 24V or 5V
GK2L = isolated com*		GK2L		
DTR		DTR		
COM	◀	COM	◀	BK
TXD	◀	RXD	◀	BU
RXD	◀	TXD	◀	PK
RTS	◀	CTS	◀	RD
CTS	◀	RTS	◀	VT
-out	◀	-out	◀	GN
+analog	◀	+analog	◀	YE
switch		switch		
thermal		thermal		
+0...10V		+0...10V		
-ana in		-ana in		
+0...30V		+0...30V		
-dig in		-dig in		
0V	supply	0V	◀	WH
+24VDC	supply	+24VDC	◀	BN
+12VDC		+12VDC		



T24 			cable	KT15II option 
Interface host		Interface Pyrometer		isolated 2 outputs
				Interface cable colour
GK1L = isolated com	◀	GK1L	◀	GY
GK1H = isolated open collector DO	◀	GK1H	◀	BNWH / RDBU / OR
GK2H = isolated open collector DO2 / DI	◀	GK2H	◀	GNWH / GYPK / colorless
GK2L = isolated com*		GK2L		
DTR		DTR		
COM	◀	COM	◀	BK
TXD	◀	RXD	◀	BU
RXD	◀	TXD	◀	PK
RTS	◀	CTS	◀	RD
CTS	◀	RTS	◀	VT
-out	◀	-out	◀	GN
+analog	◀	+analog	◀	YE
switch		switch		
thermal		thermal		
+0...10V		+0...10V		
-ana in		-ana in		
+0...30V		+0...30V		
-dig in		-dig in		
0V	supply	0V	◀	WH
+24VDC	supply	+24VDC	◀	BN
+12VDC		+12VDC		

## Anschluss KT19II / Connection KT19II



T24 			cable	KT19II 	
Interface host		Interface Pyrometer		KT19II 2 relais	
GK1L		GK1L	◀	Interface cable colour 7pol	Interface cable colour 12pol
GK1H		GK1H	◀	◀	GY
Gk2H	◀	Gk2H	◀	◀	BNWH / RDBU / OR
GK2L	◀	GK2L	◀	◀	BN
DTR	◀	DTR	◀	◀	GNWH / GYPK / colorless
COM	◀	COM	◀	◀	RD
TXD	◀	RXD	◀	◀	BK
RXD	◀	TXD	◀	◀	PK
RTS	◀	CTS	◀	◀	VT
CTS	◀	RTS	◀	◀	GN
-out	◀	-out	◀	◀	BU
+analog	◀	+analog	◀	GN	
switch	◀	switch	◀	YE	
thermal	◀	thermal	◀	PK	
+0...10V	◀	+0...10V	◀	GY	
-ana in	◀	-ana in	◀		YE
+0...30V		+0...30V	◀		WH
-dig in		-dig in			
0V	supply	0V	◀	WH	
+24VDC	supply	+24VDC	◀	BN	
+12VDC		+12VDC			

T24 			cable	KT19II 	
Interface host		Interface Pyrometer		KT19II 1 relais + ext ambient	
GK1L		GK1L		Interface cable colour 7pol	Interface cable colour 12pol
GK1H		GK1H			
Gk2H	◀	Gk2H	◀	◀	BN
GK2L	◀	GK2L	◀	◀	GNWH / GYPK / colorless
DTR	◀	DTR	◀	◀	RD
COM	◀	COM	◀	◀	BK
TXD	◀	RXD	◀	◀	PK
RXD	◀	TXD	◀	◀	VT
RTS	◀	CTS	◀	◀	GN
CTS	◀	RTS	◀	◀	BU
-out	◀	-out	◀	GN	
+analog	◀	+analog	◀	YE	
switch	◀	switch	◀	PK	
thermal	◀	thermal	◀	GY	
+0...10V	◀	+0...10V	◀		YE
-ana in	◀	-ana in	◀		WH
+0...30V	◀	+0...30V	◀		GY
-dig in	◀	-dig in	◀		BNWH / RDBU / OR
0V	supply	0V	◀	WH	
+24VDC	supply	+24VDC	◀	BN	
+12VDC		+12VDC			



## Anschluss LS12 / Connection LS12

T24 			cable	LS12 	
Interface host		Interface Pyrometer		use RS232 only	
				Interface cable colour 12pol	
GK1L		GK1L			
GK1H		GK1H			
Gk2H		Gk2H			
GK2L		GK2L			
DTR	◀	DTR	◀	BNWH / RDBU / OR	
COM	◀	COM	◀	BK	
TXD	◀	RXD	◀	BU	
RXD	◀	TXD	◀	PK	
RTS	◀	CTS	◀	RD	
CTS	◀	RTS	◀	VT	
-out	◀	-out	◀	GN	
+analog	◀	+analog	◀	YE	
switch	◀	switch	◀	GY	
thermal	◀	thermal	◀	GNWH / GYPK / colorless	
+0...10V		+0...10V			
-ana in		-ana in			
+0...30V		+0...30V			
-dig in		-dig in			
0V	supply	0V	◀	WH	
+24VDC	supply	+24VDC	◀	BN	
+12VDC		+12VDC			



## Anschluss LS12 / Connection LS12

T24 			cable	LS12 	
Interface host		Interface Pyrometer		use analog out only	
					Interface cable 7pol
GK1L		GK1L			
GK1H		GK1H			
Gk2H	◀	Gk2H			
GK2L	◀	GK2L			
DTR	◀	DTR			
COM	◀	COM			
TXD	◀	RXD			
RXD	◀	TXD			
RTS	◀	CTS			
CTS	◀	RTS			
-out	◀	-out	◀		GN
+analog	◀	+analog	◀		YE
switch	◀	switch	◀		PK
thermal	◀	thermal	◀		GY
+0...10V	◀	+0...10V			
-ana in	◀	-ana in			
+0...30V	◀	+0...30V			
-dig in	◀	-dig in			
0V	supply	0V	◀		WH
+24VDC	supply	+24VDC	◀		BN
+12VDC		+12VDC			

## Anschluss LS12 / Connection LS12

T24 			cable	LS12 	
Interface host		Interface Pyrometer		use RS232 and analog output	
				Interface cable colour 7pol	Interface cable colour 12pol
GK1L		GK1L			
GK1H		GK1H			
Gk2H		Gk2H			
GK2L		GK2L			
DTR	◀	DTR	◀		BNWH / RDBU / OR
COM	◀	COM	◀		BK
TXD	◀	RXD	◀		BU
RXD	◀	TXD	◀		PK
RTS	◀	CTS	◀		RD
CTS	◀	RTS	◀		VT
-out	◀	-out	◀	GN	
+analog	◀	+analog	◀	YE	
switch	◀	switch	◀	PK	
thermal	◀	thermal	◀	GY	
+0...10V		+0...10V			
-ana in		-ana in			
+0...30V		+0...30V			
-dig in		-dig in			
0V	supply	0V	◀	WH	
+24VDC	supply	+24VDC	◀	BN	
+12VDC		+12VDC			

## Anschluss CT13 / Connection CT13

T24 		cable	CT13 
Interface host			option 2 x digital output
			Interface cable colour 12pol
GK1L=COM**	◀		
GK1H=OC1	◀	◀	GY
Gk2H=OC2	◀	◀	GNWH / GYPK / colorless
GK2L=COM*	◀		
DTR	◀	◀	BNWH / RDBU / OR
COM	◀	◀	BK
RXD	◀	◀	BU
TXD	◀	◀	PK
CTS	◀	◀	RD
RTS	◀	◀	VT
-out	◀	◀	GN
+analog	◀	◀	YE
switch			
thermal			
+0...10V			
-ana in			
+0...30V			
-dig in			
0V	supply	◀	WH
+24VDC	supply	◀	BN
+12VDC			



\* J3 closed

\*\* J1 closed

OC2=open collector2

OC1=open collector1

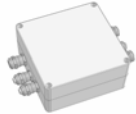
## Anschluss CT13 / Connection CT13

T24 		Interface Pyrometer		cable	CT13 
Interface host					option digital input and output
					Interface cable colour 12pol
GK1L=COM**	◀		GK1L		
GK1H=OC1	◀		GK1H	◀	GY
Gk2H=DI	◀		Gk2H	◀	GNWH / GYPK / colorless
GK2L=COM*	◀		GK2L		
DTR	◀		DTR	◀	BNWH / RDBU / OR
COM	◀		COM	◀	BK
RXD	◀		RXD	◀	BU
TXD	◀		TXD	◀	PK
CTS	◀		CTS	◀	RD
RTS	◀		RTS	◀	VT
-out	◀		-out	◀	GN
+analog	◀		+analog	◀	YE
switch			switch		
thermal			thermal		
+0...10V			+0...10V		
-ana in			-ana in		
+0...30V			+0...30V		
-dig in			-dig in		
0V	supply		0V	◀	WH
+24VDC	supply		+24VDC	◀	BN
+12VDC			+12VDC		



\* J3 closed

\*\* J1 closed

DI=digital input

OC1=open collector1

## Anschluss CT09 / Connection CT09

T24 		cable	CT09 
Interface host			option digital input
			Interface cable colour 7pol
GK1L			
GK1H			
Gk2H=DI	◀	◀	PK
GK2L=COM*			
DTR			
COM=0V**			
RXD	◀	◀	BU
TXD	◀	◀	GR
CTS			
RTS			
-out	◀	◀	GN
+analog	◀	◀	YE
switch			
thermal			
+0...10V			
-ana in			
+0...30V			
-dig in			
0V=COM***	supply	◀	WH
+24VDC	supply	◀	BN
+12VDC			



\* J1 closed

\*\* J3 closed

\*\*\* J2 closed

DI=digital input

## Anschluss CT09 / Connection CT09

T24 		cable	CT09 
Interface host			option digital output
			Interface cable colour 7pol
GK1L			
GK1H			
Gk2H=OC	◀	◀	PK
GK2L=COM*			
DTR			
COM=0V**			
RXD	◀	◀	BU
TXD	◀	◀	GR
CTS			
RTS			
-out	◀	◀	GN
+analog	◀	◀	YE
switch			
thermal			
+0...10V			
-ana in			
+0...30V			
-dig in			
0V=COM***	supply	◀	WH
+24VDC	supply	◀	BN
+12VDC			



\* J1 closed

\*\* J3 closed

\*\*\* J2 closed

OC=open collector

## Anschluss CT08 / Connection CT08

T24 		cable	CT08 
Interface host			option digital input
			Interface cable colour 7pol
GK1L			
GK1H			
Gk2H=DI	◀	◀	PK
GK2L=COM*			
DTR			
COM=0V**			
RXD	◀	◀	BU
TXD	◀	◀	GR
CTS			
RTS			
-out	◀	◀	GN
+analog switch	◀	◀	YE
thermal			
+0...10V			
-ana in			
+0...30V			
-dig in			
0V=COM***	supply	◀	WH
+24VDC			
+12VDC	supply	◀	BN



\* J1 closed

\*\* J3 closed

\*\*\* J2 closed

DI=digital input

## Anschluss CT08 / Connection CT08

T24 		cable	CT08 
Interface host			option digital output
			Interface cable colour 7pol
GK1L			
GK1H			
Gk2H=OC	◀	◀	PK
GK2L=COM*			
DTR			
COM=0V**			
RXD	◀	◀	BU
TXD	◀	◀	GR
CTS			
RTS			
-out	◀	◀	GN
+analog switch thermal	◀	◀	YE
+0...10V			
-ana in			
+0...30V			
-dig in			
0V=COM***	supply	◀	WH
+24VDC			
+12VDC	supply	◀	BN



\* J1 closed

\*\* J3 closed



\*\*\* J2 closed

OC=open collector

# Anschluss KTX / Connection KTX

T24 			cable	KTX 
Interface host		Interface Pyrometer		
				Interface cable colour 4pol
GK1L		GK1L		
GK1H		GK1H		
Gk2H		Gk2H		
GK2L		GK2L		
DTR		DTR		
COM		COM		
RXD		RXD		
TXD		TXD		
CTS		CTS		
RTS		RTS		
-out	◀	-out	◀	GN
+analog switch	◀	+analog switch	◀	YE
thermal		thermal		
+0...10V		+0...10V		
-ana in		-ana in		
+0...30V		+0...30V		
-dig in		-dig in		
0V=COM***	supply	0V	◀	WH
+24VDC	supply	+24VDC	◀	BN
+12VDC		+12VDC		

## Anschluss KT18R / Connection KT18R

T24 			cable	KT18R 	
Interface host		Interface Pyrometer			
					Interface cable colour 4pol
GK1L		GK1L			
GK1H		GK1H			
Gk2H		Gk2H			
GK2L		GK2L			
DTR		DTR			
COM		COM			
RXD		RXD			
TXD		TXD			
CTS		CTS			
RTS		RTS			
-out	◀	-out	◀		RD
+analog	◀	+analog	◀		WH
switch		switch			
thermal		thermal			
+0...10V		+0...10V			
-ana in		-ana in			
+0...30V		+0...30V			
-dig in		-dig in			
0V=COM***	supply	0V	◀		GYPK / colourless
+24VDC	supply	+24VDC	◀		GY
+12VDC		+12VDC			

## Kompatibilitätsliste / *Compatibility list*

Gerät / Type		Anschlussplan / Wiring Diagram
CT08	siehe / see	CT08
CT09	siehe / see	CT09
CT11	siehe / see	CT13
CT13	siehe / see	CT13
CT15	siehe / see	KT15II
KT15II	siehe / see	KT15II
KT18R	siehe / see	KT18R
KT19II	siehe / see	KT19II
KTX	siehe / see	KTX
TRTx2	siehe / see	KT19II
TRTx3	siehe / see	KT19II
LS12 / KT15II	siehe / see	LS12
LS12 / KT19II	siehe / see	LS12
LT15EB	siehe / see	KT15II
LT13EB	siehe / see	CT13
Vorläufermodell / Forerunner model		
KT15D 12pol.	siehe / see	KT15II Standard
KT15D 7pol.	siehe / see	KT15II Standard ohne (without) RS232
KT15SMD	siehe / see	KTX
KT11	siehe / see	CT08 ohne (without) RS232 und (and) Dig in/out
KT12	siehe / see	KTX
KT19	siehe / see	KT19II

**Belegung HEITRONICS Schnittstellenkabel  
PVC (95504214) und PTFE (95504217)**

**Assignment HEITRONICS Interface-cable  
PVC (95504214) and PTFE (95504217)**

Funktion / Signal PC	Sub-D Stecker Kontakt PC	Adernfarbe / Cable Colour	Adernfarbe (DIN IEC 757)
DSR	6	rot / red	RD
CTS	8	blau / blue	BU
RTS	4	grün / green	GN
TXD	3	rosa / pink	PK
RXD	2	violett / violet	VT
COM	5	schwarz / black	BK

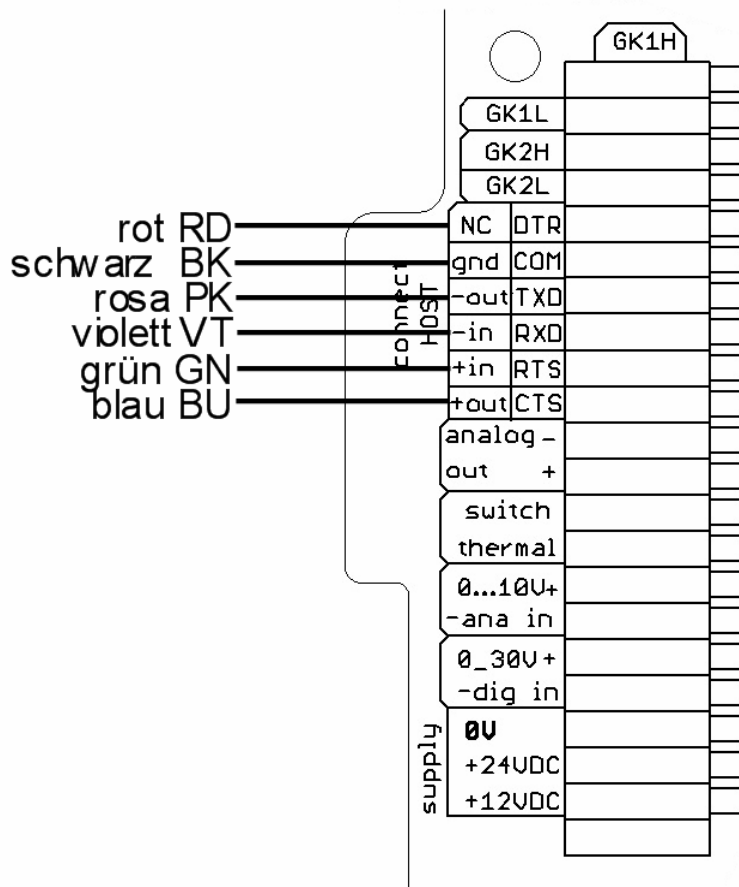

## Jumperpositionen / Position of Jumpers

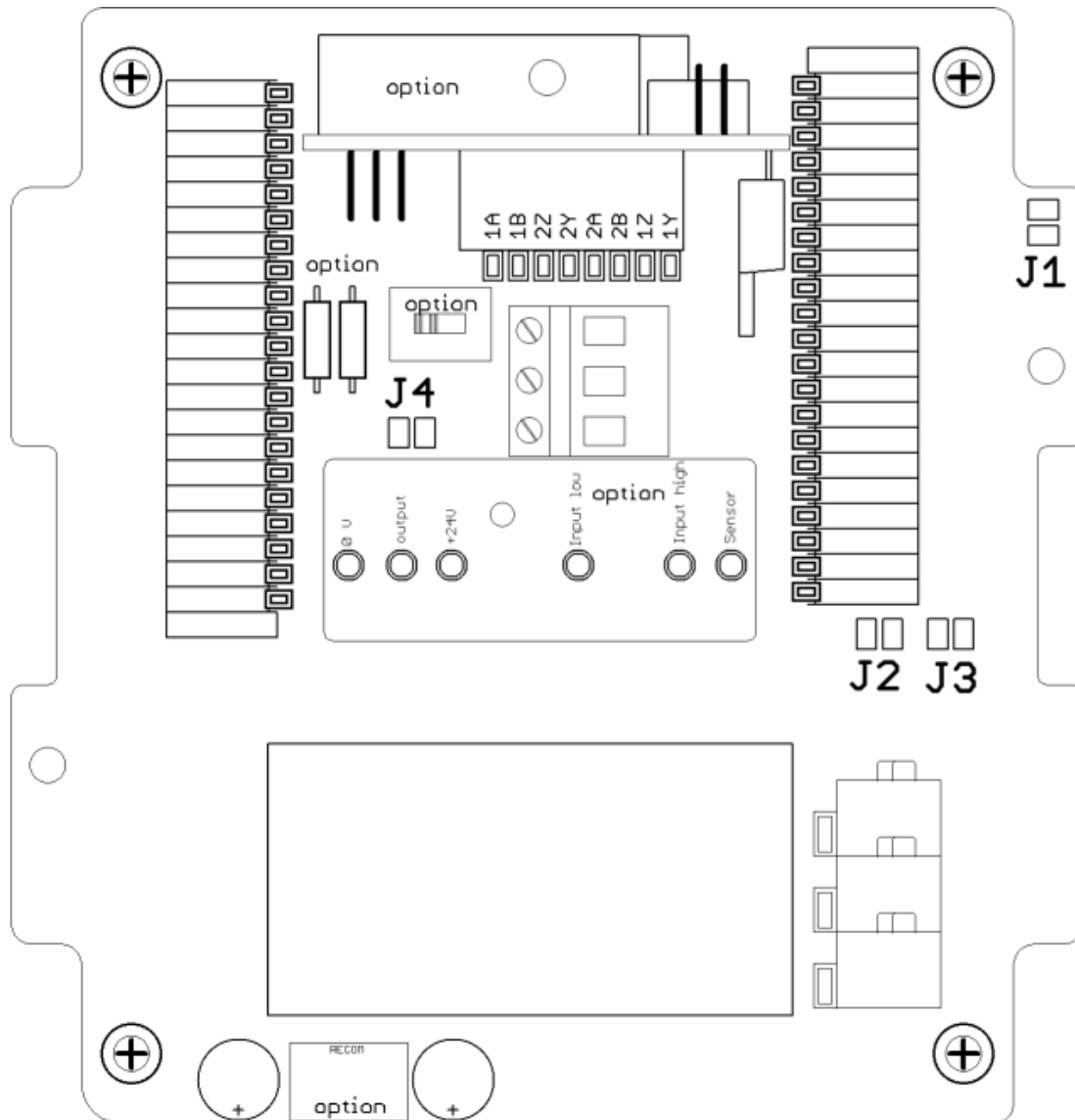

# Schaltplan / Wiring Diagram

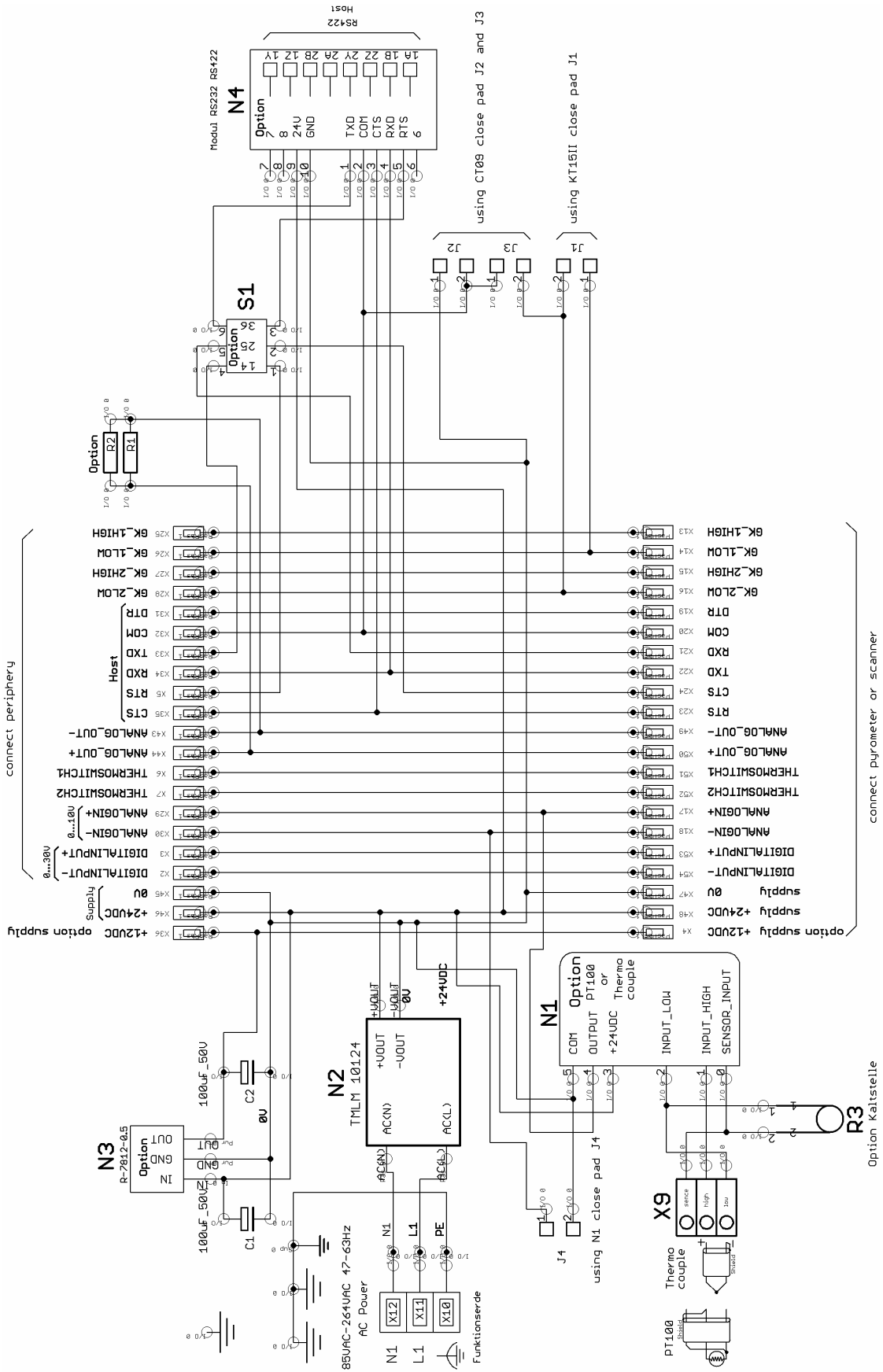

## Service

HEITRONICS Infrarot Messtechnik GmbH  
Kreuzberger Ring 40  
65205 WIESBADEN  
GERMANY

Tel.: +49 (0)611 97393-0  
Fax: +49 (0)611 97393-26

E-Mail: [info@heitronics.com](mailto:info@heitronics.com)  
Internet: [www.heitronics.com](http://www.heitronics.com)

---

### **Vertriebsorganisation**

Angaben zu unseren regionalen Vertriebspartnern finden Sie im Internet.

### **Sales Network**

For details about our regional representatives, please, refer to the internet.

### **Réseau des ventes**

Vous pouvez trouver les coordonnées de nos représentants régionaux sur Internet.

### **Organizacion de la venta**

Información referente a nuestros regionales colaboradores de venta encuentran en el internet.



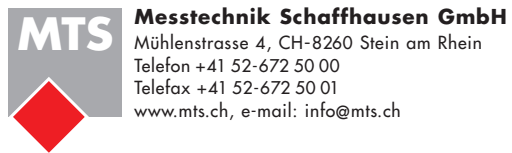

**Messtechnik Schaffhausen GmbH**

Mühlenstrasse 4, CH-8260 Stein am Rhein

Telefon +41 52-672 50 00

Telefax +41 52-672 50 01

[www.mts.ch](http://www.mts.ch), e-mail: [info@mts.ch](mailto:info@mts.ch)

**Messen Prüfen Automatisieren [www.mts.ch](http://www.mts.ch)**