



- **DK** Side 1
- **UK** Page 25
- **FR** Page 51
- **DE** Seite 77

# 9 1 1 3

**Temperature /  
mA converter**

No. 9113V102-IN (1035)  
Product version: 9113-002



**Messtechnik  
Schaffhausen GmbH**  
CH-8260 Stein am Rhein  
Telefon +41 52-672 50 00

**SIGNALS THE BEST**

Messen Prüfen Automatisieren [www.mts.ch](http://www.mts.ch)

- DK** ▶ PR electronics A/S tilbyder et bredt program af analoge og digitale signalbehandlingsmoduler til industriel automation. Programmet består af Isolatorer, Displays, Ex-barrierer, Temperaturtransmittere, Universaltransmittere mfl. Vi har modulerne, du kan stole på i selv barske miljøer med elektrisk støj, vibrationer og temperaturudsving, og alle produkter opfylder de strengeste internationale standarder. Vores motto »Signals the Best« er indbegrebet af denne filosofi – og din garanti for kvalitet.
- UK** ▶ PR electronics A/S offers a wide range of analogue and digital signal conditioning devices for industrial automation. The product range includes Isolators, Displays, Ex Interfaces, Temperature Transmitters, and Universal Devices. You can trust our products in the most extreme environments with electrical noise, vibrations and temperature fluctuations, and all products comply with the most exacting international standards. »Signals the Best« is the epitome of our philosophy – and your guarantee for quality.
- FR** ▶ PR electronics A/S offre une large gamme de produits pour le traitement des signaux analogiques et numériques dans tous les domaines industriels. La gamme de produits s'étend des transmetteurs de température aux afficheurs, des isolateurs aux interfaces SI, jusqu'aux modules universels. Vous pouvez compter sur nos produits même dans les conditions d'utilisation sévères, p.ex. bruit électrique, vibrations et fluctuations de température. Tous nos produits sont conformes aux normes internationales les plus strictes. Notre devise »SIGNALS the BEST« c'est notre ligne de conduite - et pour vous l'assurance de la meilleure qualité.
- DE** ▶ PR electronics A/S verfügt über ein breites Produktprogramm an analogen und digitalen Signalverarbeitungsmodulen für die industrielle Automatisierung. Dieses Programm umfasst Displays, Temperaturtransmitter, Ex- und galvanische Signaltrenner, und Universalgeräte. Sie können unsere Geräte auch unter extremen Einsatzbedingungen wie elektrisches Rauschen, Erschütterungen und Temperaturschwingungen vertrauen, und alle Produkte von PR electronics werden in Übereinstimmung mit den strengsten internationalen Normen produziert. »Signals the Best« ist Ihre Garantie für Qualität!

# TEMPERATUR- / mA-KONVERTER

## 9113

### INDHOLDSFORTEGNELSE

Advarsel.....	2
Signaturforklaring .....	2
Sikkerhedsregler.....	2
Afmontering af system 9000 .....	4
EF-Overensstemmelseserklæring .....	5
Avancerede features.....	6
Anvendelse .....	6
Teknisk karakteristik .....	6
Applikationer .....	7
PR 4501 Display- / programmeringsfront .....	8
Bestillingsnumre .....	9
Elektriske specifikationer.....	9
Konfigurering af følerfejlscheck.....	14
Displayvisning på 4501 af:	
Indgangssignal uden for område .....	14
Følerfejlsdetektering .....	14
Hardwarefejl .....	14
Tilslutninger .....	16
Blokdiagram .....	17
Visning af signal- og kabelfejl uden displayfront .....	18
Programmering / betjening af trykknapper .....	19
Rutediagram .....	21
Rutediagram, Avancerede indstillinger (ADV.SET) .....	23
Rullende hjælpetekster i displaylinie 3.....	24
Appendix .....	102
IECEx Installation Drawing .....	103
ATEX Installation Drawings, UK, FR, DE, DK.....	106
FM Installation Drawing.....	118
Safety Manual .....	121



## ADVARSEL

Følgende operationer bør kun udføres på modulet i spændingsløs tilstand og under ESD-sikre forhold:

Installation, ledningsmontage og -demontage.

Fejlfinding på modulet.

**Reparation af modulet og udskiftning af sikringer må kun foretages af PR electronics A/S.**



## ADVARSEL

Modulets frontplade må ikke åbnes, da dette vil medføre skade på stikforbindelsen til display- / programmeringsfronten PR 4501. Modulet indeholder ingen DIP-switches eller jumbere.

## SIGNATURFORKLARING



**Trekant med udråbstegn:** Læs manualen før installation og idriftsættelse af modulet for at undgå hændelser, der kan føre til skade på personer eller materiel.



**CE-mærket** er det synlige tegn på modulets overensstemmelse med EU-direktivernes krav.



**Dobbelt isolation** er symbolet for, at modulet overholder ekstra krav til isolation.



**Ex** - Modulet er godkendt efter ATEX-direktivet til brug i forbindelse med installationer i eksplosionsfarlige områder.

## SIKKERHEDSREGLER

### DEFINITIONER

**Farlige spændinger** er defineret som områderne: 75...1500 Volt DC og 50...1000 Volt AC.

**Teknikere** er kvalificerede personer, som er uddannet eller oplært til at kunne udføre installation, betjening eller evt. fejlfinding både teknisk og sikkerhedsmæssigt forsvarligt.

**Operatører** er personer, som under normal drift med produktet skal indstille og betjene produktets trykknapper eller potentiometre, og som er gjort bekendt med indholdet af denne manual.

## **MODTAGELSE OG UDPAKNING**

Udpak modulet uden at beskadige det. Kontrollér ved modtagelsen, at modul-typen svarer til den bestilte. Indpakningen bør følge modulet, indtil dette er monteret på blivende plads.

## **MILJØFORHOLD**

Undgå direkte sollys, kraftigt støv eller varme, mekaniske rystelser og stød, og udsæt ikke modulet for regn eller kraftig fugt. Om nødvendigt skal opvarmning, ud over de opgivne grænser for omgivelsestemperatur, forhindres ved hjælp af ventilation.

Modulet skal installeres i forureningsgrad 2 eller bedre.

Modulet er designet til at være sikkert mindst op til en højde af 2000 m.

## **INSTALLATION**

Modulet må kun tilsluttes af teknikere, som er bekendte med de tekniske udtryk, advarsler og instruktioner i manualen, og som vil følge disse.

Hvis der er tvivl om modulets rette håndtering, skal der rettes henvendelse til den lokale forhandler eller alternativt direkte til:

**PR electronics A/S, Lerbakken 10, 8410 Rønde,  
Danmark, tlf: +45 86 37 26 77.**

Det er ikke tilladt at benytte flerkoret ledning ved tilslutning af forsyningsspænding med mindre ledningsenderne er forsynet med ledningstykker.

Beskrivelse af indgang / udgang og forsyningsforbindelser findes på blokdiagrammet og sideskiltet.

Modulet er forsynet med skrueterminaler og skal forsynes fra en dobbeltisoleret / forstærket isoleret spændingsforsyning. En afbryder placeres let tilgængeligt og tæt ved modulet. Afbryderen skal mærkes således, at der ikke er tvivl om, at den afbryder spændingen til modulet.

Ved installation på Power Rail 9400 bliver forsyningsspændingen leveret af Power Control Unit type 9410.

Produktionsår fremgår af de to første cifre i serienummeret.

## **KALIBRERING OG JUSTERING**

Under kalibrering og justering skal måling og tilslutning af eksterne spændinger udføres i henhold til denne manual, og teknikeren skal benytte sikkerhedsmæssigt korrekte værktøjer og instrumenter.

## **BETJENING UNDER NORMAL DRIFT**

Operatører må kun indstille eller betjene modulerne, når disse er fast installeret

på forsvarlig måde i tavler el. lignende, så betjeningen ikke medfører fare for liv eller materiel. Dvs., at der ikke er berøringsfare, og at modulet er placeret, så det er let at betjene.

### **RENGØRING**

Modulet må, i spændingsløs tilstand, rengøres med en klud let fugtet med destilleret vand.

### **ANSVAR**

I det omfang instruktionerne i denne manual ikke er nøje overholdt, vil kunden ikke kunne rette noget krav, som ellers måtte eksistere i henhold til den indgåede salgsaftale, mod PR electronics A/S.

## **AFMONTERING AF SYSTEM 9000**

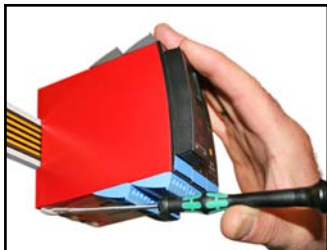

### **Billede 1:**

Modulet frigøres fra DIN-skinen ved at løfte i den nederste lås.

# EF-OVERENSSTEMMELSESERKLÆRING

Som producent erklærer

**PR electronics A/S**  
**Lerbakken 10**  
**DK-8410 Rønde**

hermed at følgende produkt:

**Type: 9113**  
**Navn: Temperatur- / mA-konverter**

er i overensstemmelse med følgende direktiver og standarder:

EMC-direktivet 2004/108/EF og senere tilføjelser

**EN 61326-1 : 2006**

For specifikation af det acceptable EMC-niveau henvises til modulets elektriske specifikationer.

Lavspændingsdirektivet 2006/95/EF og senere tilføjelser

**EN 61010-1 : 2001**

ATEX-direktivet 94/9/EF og senere tilføjelser

**EN 61241-0:2006, EN 61241-11:2006, EN 60079-0:2006,**  
**EN 60079-11:2007, EN 60079-15:2005, EN 60079-26:2007**  
**ATEX certificate: KEMA 07ATEX0148 X**

Bemyndiget organ:

**KEMA Quality B.V. (0344)**  
**Utrechtseweg 310, 6812 AR Arnhem**  
**P.O. Box 5185, 6802 ED Arnhem**  
**The Netherlands**

Rønde, 24. september 2009

---

Kim Rasmussen  
Producentens underskrift

# TEMPERATUR- / mA-KONVERTER

## 9113

- *Indgang for RTD, TC og mA*
- *Aktiv / passiv mA-udgang*
- *1 eller 2 kanaler*
- *Kan forsynes separat eller installeres på power rail, PR type 9400*
- *SIL 2-certificeret via Full Assessment*

### Avancerede features

- Konfiguration og monitorering via aftagelig displayfront (PR 4501); proceskalibrering og signalsimulering.
- Kopiering af opsætningen fra et modul til andre af samme type via displayfronten.
- TC-indgange kan anvende enten intern CJC eller en klemme med indbygget Pt100-føler (PR 5910Ex, kanal 1 / PR 5913Ex, kanal 2) for højere nøjagtighed.
- 9113 detekterer automatisk, om modulet skal levere et aktivt eller et passivt strømsignal.
- Avanceret monitorering af intern kommunikation og gemte data.
- SIL 2-funktionaliteten skal aktivt tilvælges via menupunkt.

### Anvendelse

- 9113 kan monteres i sikkert område samt i zone 2 / division 2 og modtage signaler fra zone 0, 1, 2, 20, 21 og 22 / Class I/II/III, Div. 1, Gr. A-G.
- Konvertering og skalering af temperatursignaler (Pt, Ni og TC) og aktive strømsignaler.
- 9113 er konstrueret, udviklet og certificeret til brug i SIL 2-installationer iht. kravene i IEC 61508.

### Teknisk karakteristik

- 1 grøn og 2 røde LEDs i front indikerer normal drift og funktionsfejl.
- 2,6 kVAC galvanisk isolation mellem indgang / udgang / forsyning.

# APPLIKATIONER

## Indgangssignaler:

Kanal 1:

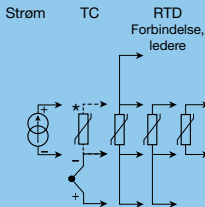

\*Bestilles særskilt: CJC-klemme 5910Ex / 5913Ex

Kanal 2:

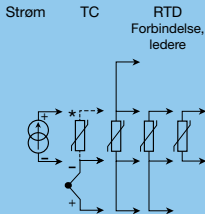

\*Bestilles særskilt: CJC-klemme 5910Ex / 5913Ex

**Zone 0, 1, 2,  
20, 21, 22 /  
Cl. I/II/III, div. 1  
gr. A-G**

## Udgangssignaler:

Analog, 0/4...20 mA

Kanal 2:

2-trådsforsyning -



Kanal 1:

2-trådsforsyning -



Power rail

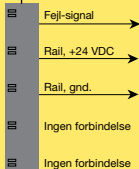

## Forsyningsspændinger:

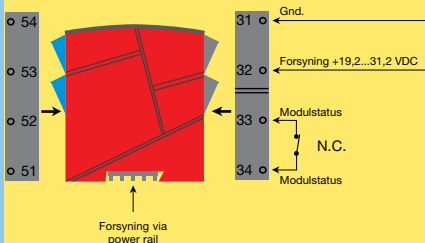

Forsyning via  
power rail

**Zone 2 / Cl. 1, div. 2, gr. A-D eller sikkert område**

# PR 4501 DISPLAY- / PROGRAMMERINGSFRONT



## Funktionalitet

Den enkle menustruktur og de forklarende hjælpe-tekster leder dig automatisk gennem opsætningen, og gør produktet meget enkelt at anvende. Se beskrivelse af funktioner og opsætningsmuligheder under afsnittet "Programmering / betjening af trykknapper".

## Anvendelse

- Kommunikationsinterface til ændring af driftsparametre i 9113.
- Kan flyttes fra en 9113 til en anden 9113 og downloade opsætningen fra det første modul til andre af samme type.
- Som fastmonteret display til visualisering af procesdata og status.

## Teknisk karakteristisk

- Fire liniers LCD-display, linie 1 (5,57 mm høj) viser indgangsstatus, linie 2 og 3 (3,33 mm høje) viser analog indgangs- / udgangsværdi eller TAG-nr samt enheder - UNIT, og linie 4 viser status for kommunikation og SIL-lås. Statisk prik = SIL-låst og blinkende prik = ikke SIL-låst.
- Programmeringsadgang kan forhindres ved indkodning af et password. Passwordet gemmes i transmitteren, så sikkerheden mod uønskede ændringer er så høj som muligt.

## Montage / installation

- Klikkes på fronten af 9113.

## Bestillingsnumre

<b>9113BA</b>	=	<b>Temperatur- / mA-konverter, 1 kanal</b>
<b>9113BB</b>	=	<b>Temperatur- / mA-konverter, 2 kanaler</b>
<b>4501</b>	=	<b>Display- / programmeringsfront</b>
<b>5910Ex</b>	=	<b>CJC-klemme, kanal 1</b>
<b>5913Ex</b>	=	<b>CJC-klemme, kanal 2</b>
<b>9400</b>	=	<b>Power rail</b>

## Elektriske spesifikationer

Specifikationsområde.....	-20...+60°C
Lagringstemperatur .....	-20...+85°C

### Fælles spesifikationer:

Forsyningsspænding, DC.....	19,2...31,2 VDC
Max. forbrug.....	≤ 3,5 W (2 kanaler)
Sikring .....	400 mA T / 250 VAC
Isolationsspændinger, test / drift	
Indgang / udgang / forsyning.....	2,6 kVAC / 250 VAC
Udgang 1 til udgang 2 .....	1,5 kVAC / 150 VAC forstærket
Statusrelæ til forsyning .....	1,5 kVAC / 150 VAC forstærket
Kommunikationsinterface.....	Programmeringsfront 4501
Signal- / støjforhold.....	Min. 60 dB (0...100 kHz)
Gennemsnitlig reaktionstid inkl. forsinkelse:	
Temperaturindgang .....	≤ 1 s
mA-indgang.....	≤ 0,4 s
Kalibreringstemperatur .....	20...28°C

Nøjagtighed, størst af generelle og basisværdier:

<b>Generelle værdier</b>		
Indgangs- type	Absolut nøjagtighed	Temperatur- koefficient
Alle	$\leq \pm 0,1\%$ af span	$\leq \pm 0,01\%$ af span / °C

<b>Basisværdier</b>		
Indgangs- type	Basis- nøjagtighed	Temperatur- koefficient
mA	$\leq \pm 16 \mu\text{A}$	$\leq \pm 1,6 \mu\text{A} / ^\circ\text{C}$
Pt100, Pt200, Pt 1000	$\leq \pm 0,2^\circ\text{C}$	$\leq \pm 0,02^\circ\text{C} / ^\circ\text{C}$
Pt500, Ni100, Ni120, Ni 1000	$\leq \pm 0,3^\circ\text{C}$	$\leq \pm 0,03^\circ\text{C} / ^\circ\text{C}$
Pt50, Pt400, Ni50	$\leq \pm 0,4^\circ\text{C}$	$\leq \pm 0,04^\circ\text{C} / ^\circ\text{C}$
Pt250, Pt300	$\leq \pm 0,6^\circ\text{C}$	$\leq \pm 0,06^\circ\text{C} / ^\circ\text{C}$
Pt20	$\leq \pm 0,8^\circ\text{C}$	$\leq \pm 0,08^\circ\text{C} / ^\circ\text{C}$
Pt10	$\leq \pm 1,4^\circ\text{C}$	$\leq \pm 0,14^\circ\text{C} / ^\circ\text{C}$
TC-type: E, J, K, L, N, T, U	$\leq \pm 1^\circ\text{C}$	$\leq \pm 0,1^\circ\text{C} / ^\circ\text{C}$
TC-type: R, S, W3, W5, LR	$\leq \pm 2^\circ\text{C}$	$\leq \pm 0,2^\circ\text{C} / ^\circ\text{C}$
TC-type: B 160...400°C	$\leq \pm 4,5^\circ\text{C}$	$\leq \pm 0,45^\circ\text{C} / ^\circ\text{C}$
TC-type: B 400...1820°C	$\leq \pm 2^\circ\text{C}$	$\leq \pm 0,2^\circ\text{C} / ^\circ\text{C}$

EMC-immunitetspåvirkning.....	$< \pm 0,5\%$ af span
Udvidet EMC-immunitet:	
NAMUR NE 21, A-kriterium, gniststøj.....	$< \pm 1\%$ af span

Ledningskvadrat (min....max.) ..... 0,13...2,08 mm<sup>2</sup> / AWG 14...26  
 flerkoret ledning

Klemskruetilspændingsmoment..... 0,5 Nm

Relativ luftfugtighed .....  $< 95\%$  RH (ikke kond.)

Mål, uden displayfront (HxBxD) ..... 109 x 23,5 x 104 mm

Mål, med displayfront (HxBxD) ..... 109 x 23,5 x 116 mm

Kapslingsklasse..... IP20  
 Vægt..... 250 g / 265 g med 4501

**Isolation:**

Indgang til alle ..... 300 VAC dobbelt/forstærket  
 Analog udgang til forsyning ..... 300 VAC dobbelt/forstærket  
 Statusrelæ til forsyning..... 150 VAC dobbelt/forstærket eller  
 300 VAC basis-isolation

**RTD-indgang:**

Indgangs- type	Min. værdi	Max. værdi	Standard
Pt100 Ni100	-200°C -60°C	+850°C +250°C	IEC60751 DIN 43760

Indgang for RTD-typer:

Pt10\*, Pt20\*, Pt50\*, Pt100, Pt200, Pt250, Pt300, Pt400, Pt500, Pt1000  
 Ni50, Ni100, Ni120, Ni1000

Kabelmodstand pr. leder, (max.), ..... 50 Ω  
 Følerstrøm, RTD ..... Nom. 0,2 mA

Virkning af følerkabelmodstand

(3- / 4-leder), RTD ..... < 0,002 Ω / Ω

Følerfejlsdetektering, RTD..... Programmerbar ON / OFF

Følerfejlsstrøm:

under detektering ..... < 2 µA

ellers..... 0 µA

\* Ingen kortslutningsdetektering for Pt10, Pt20 og Pt50

**TC-indgang:**

Type	Min. værdi	Max. værdi	Standard
B	0°C	+1820°C	IEC 60584-1
E	-100°C	+1000°C	IEC 60584-1
J	-100°C	+1200°C	IEC 60584-1
K	-180°C	+1372°C	IEC 60584-1
L	-200°C	+900°C	DIN 43710
N	-180°C	+1300°C	IEC 60584-1
R	-50°C	+1760°C	IEC 60584-1
S	-50°C	+1760°C	IEC 60584-1
T	-200°C	+400°C	IEC 60584-1
U	-200°C	+600°C	DIN 43710
W3	0°C	+2300°C	ASTM E988-90
W5	0°C	+2300°C	ASTM E988-90
LR	-200°C	+800°C	GOST 3044-84

Koldt loddestedskomp. (CJC):	
via ekstern føler i klemme 5910 .....	20...28°C $\leq$ $\pm$ 1°C
via intern CJC-føler .....	-20...20°C og 28...70°C $\leq$ $\pm$ 2°C
	$\pm(2,0^\circ\text{C} + 0,4^\circ\text{C} * \Delta t)$

$\Delta t$  = intern temperatur - omgivelsestemperatur

Følerfejlsdetektering ..... Programmerbar ON eller OFF  
(kun kabelbrud)

Følerfejlsstrøm:

  under detektering..... Nom. 2  $\mu\text{A}$   
  ellers..... 0  $\mu\text{A}$

### Strømindgang:

Måleområde ..... 0...20 mA  
Programmerbare måleområder ..... 0...20 og 4...20 mA  
Indgangsmodstand ..... Nom. 20  $\Omega$  + PTC 50  $\Omega$   
Følerfejlsdetektering ..... Programmerbar ON / OFF  
Kun 4...20 mA (NAMUR)

### Strømodgang:

Signalområde (span) ..... 0...20 mA  
Programmerbare signalområder ..... 0...20 / 4...20 /  
20...0 og 20...4 mA  
Belastning (max.)..... 20 mA / 600  $\Omega$  / 12 VDC  
Belastningsstabilitet .....  $\leq$  0,01% af span / 100  $\Omega$   
Følerfejlsdetektering ..... 0 / 3,5 / 23 mA / ingen  
NAMUR NE 43 Up- / Downscale ..... 23 mA / 3,5 mA  
Begrænsning af udgang:  
  på 4...20 og 20...4 mA signaler ..... 3,8...20,5 mA  
  på 0...20 og 20...0 mA signaler ..... 0...20,5 mA  
Strømbegrænsning.....  $\leq$  28 mA

### 2-tråds 4...20 mA udgang:

Signalområde ..... 4...20 mA  
Belastningsstabilitet .....  $\leq$  0,01% af span / 100  $\Omega$   
Belastningsmodstand.....  $\leq$  ( $V_{\text{forsyn.}}$  -3,5) / 0,023 A [ $\Omega$ ]  
Område for ekstern 2-trådsforsyning..... 3,5...26 VDC  
Virkning af ekstern 2-trådsforsynings-  
spændingsændring .....  $<$  0,005% af span / V

### Statusrelæ i sikkert område:

Max. spænding ..... 125 VAC / 110 VDC  
Max. strøm ..... 0,5 AAC / 0,3 ADC  
Max. effekt..... 62,5 VA / 32 W

### Marine-godkendelse:

Det Norske Veritas, Ships & Offshore ..... Ansøgt

**GOST R godkendelse:**VNIIFTRI, Cert No..... Se [www.prelectronics.dk](http://www.prelectronics.dk)**SIL-certificering:**

exida, Cert No. .... PREI 070902 P0002 C03.01

**Overholdte myndighedskrav:**

EMC 2004/108/EF ..... EN 61326-1

LVD 2006/95/EF ..... EN 61010-1

ATEX 94/9/EF ..... EN 60079-0, -11, -15, -26  
og EN 61241-0, -11IECEx..... IEC 60079-0, -11, -15 og -26  
IEC 61241-0 og -11

c FM us ..... FM 3600, 3611, 3810

CSA E60079-0, -15

CSA 22.2 -25, -142, -213

ANSI/ISA-12.00.01 / 12.12.02

UL, Standard for Safety ..... UL 61010-1

SIL ..... IEC 61508

**af span** = af det aktuelt valgte måleområde

## Konfigurering af følerfejlscheck

Følerfejlscheck:		
Modul:	Konfiguration	Følerfejlsdetektering:
9113	OUT.ERR=NONE.	OFF
	Ellers:	ON

## Displayvisning på 4501 af: Indgangssignal uden for område

Uden for område visning (IN.LO, IN.HI): Ved overskridelse af A/D-konverterens eller polynomiets gyldige område			
Indgang	Område	Visning	Grænse
CURR	0...20 mA / 4...20 mA	IN.LO	< -1,05 mA
		IN.HI	> 25,05 mA
TEMP	TC / RTD	IN.LO	< temperaturområde -2°C
		IN.HI	> temperaturområde +2°C

Display under min.- / over max.-visning (-1999, 9999):			
Indgang	Område	Visning	Grænse
Alle	Alle	-1999	Displayværdi <-1999
		9999	Displayværdi >9999

## Følerfejlsdetektering

Sensor error detection (SE.BR, SE.SH):			
Indgang	Område	Visning	Grænse
CURR	Strømsløjfebrud (4...20 mA)	SE.BR	<= 3,6 mA; > = 20,75 mA
TEMP	TC	SE.BR	> 10 kΩ...165 kΩ
		SE.SH	> 900...1000 Ω (kabel > 50 Ω)
	RTD: 2-, 3- og 4-leder For Pt10, Pt20, Pt50, Pt100, Pt200, Ni50 og Ni120	SE.BR	> 10...12 kΩ (kabel > 50 Ω)
		SE.SH	< ca. 15 Ω
RTD: 2-, 3- og 4-leder for Pt250, Pt300, Pt400, Pt500, Pt1000 og Ni1000	SE.BR	> 10...12 kΩ (kabel > 50 Ω)	
	SE.SH	< ca. 15 Ω	

## Hardwarefejl

Visning ved hardwarefejl		
Fejlsøgning	Visning	Årsag
Indgang uden for område (lavt indgangssignal)	IN.LO	Se grænser ovenfor
Indgang uden for område (højt indgangssignal)	IN.HI	Se grænser ovenfor
Føler kabelbrud	SE.BR	Se grænser ovenfor
Føler kortslutning	SE.SH	Se grænser ovenfor
Test af intern CJC-føler	CJ.ER	Intern CJC-føler defekt eller CJC-temperatur uden for område**
CJC-klemme fejl - check CJC-terminal	CJ.CE	Defekt eller manglende CJC-klemme, temperatur uden for gyldigt område

Visning ved hardwarefejl		
Fejlsøgning	Visning	Årsag
Fejl på indgangen - check indgangsforbindelser samt sluk og tænd for modulet	IN.ER	Signalniveauer på indgang uden for grænser eller forbundet til forkerte terminaler*
Fejl på udgangen - check udgangsforbindelser samt sluk og tænd for modulet	AO.ER	Fejl i analog udgangsstrøm (kun for SIL-mode)*
Ingen kommunikation	NO.CO	Ingen kommunikation med (4501)
Fejl i flash - check konfigurationen	FL.ER CO.ER	Fejl i FLASH (ugyldig konfiguration)***
Ugyldig konfigurationstype eller ugyldig version	TY.ER	Konfiguration hentet fra EEPROM har ugyldigt type- eller revisionsnummer
Hardwarefejl	RA.ER	Fejl i RAM*
Hardwarefejl	IF.ER	Fejl i intern Flash*
Hardwarefejl	SW.ER	Fejl i SW monitor*
Hardwarefejl	AD.ER	Fejl i A/D-konverter*
Hardwarefejl	AO.SU	Fejl i analog udgangsforsyning*
Hardwarefejl	CA.ER	Fejl i fabrikskalibrering*
Hardwarefejl	CM.ER	Fejl i primær CPU*
Hardwarefejl	II.ER	Fejl i initialiseringscheck*
Hardwarefejl	RS.ER	Reset-fejl*
Hardwarefejl	IC.ER	Fejl i kommunikation på indg.*
Hardwarefejl	M1.ER	Fejl fra primær CPU til kanal 1*
Hardwarefejl	M2.ER	Fejl fra primær CPU til kanal 2*
Hardwarefejl	MC.ER	Konfig.-fejl i primær CPU*
Hardwarefejl	MF.ER	Flash-fejl i primær CPU*
Hardwarefejl	MR.ER	RAM-fejl i primær CPU*
Hardwarefejl	MS.ER	Fejl i forsyning til primær CPU*
Hardwarefejl	MP.ER	ProgFlow-fejl i primær CPU*

! Alle fejlvisninger i display blinker 1 gang pr. sekund samt suppleres med tilhørende hjælpetekst.

\* Fejlen kan resettes ved at steppe igennem menuerne eller ved at slukke og tænde for modulet.

Nogle fejltypen kan kun resettes ved at slukke og tænde for modulet.

\*\* Fejlen kan resettes ved at steppe igennem menuerne eller ved at slukke og tænde for modulet.

Fejlen kan tilsidesættes ved at vælge en anden indgangstype end TC.

\*\*\* Fejlen kan resettes ved at steppe igennem menuerne.

# TILSLUTNINGER

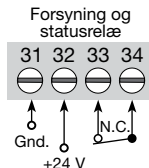
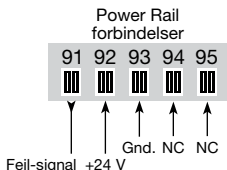

NC = ingen forbindelse

## Indgange

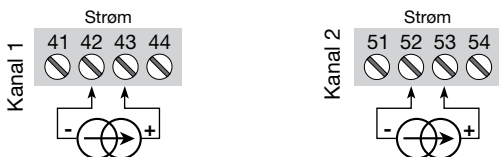
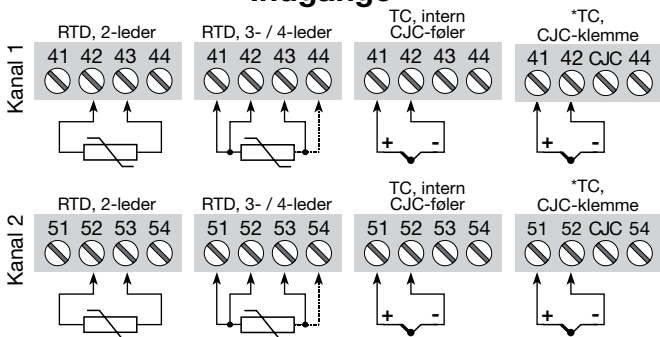

\* Bestilles særskilt:  
CJC-klemme  
5910Ex (kanal 1) /  
5913Ex (kanal 2).

## Udgange:

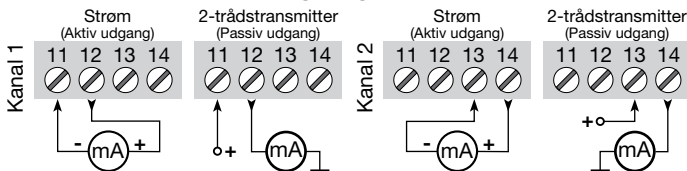



## Visning af signal- og kabelfejl uden displayfront

Liste over LED- og fejlsignalvisninger						
Tilstand	Grøn LED	Kanal 1: Rød LED	Kanal 2: Rød LED	Statusrelæ, N.C.	Power rail signalstatus	
Modul OK	Blinker	OFF	OFF	Trukket	Åben	
Ingen forsyning	OFF	OFF	OFF	Sluppet	Lukket	
Modul defekt	OFF	ON	ON	Sluppet	Lukket	
Kanal 1 defekt (kanal 2 OK)	Blinker	ON	OFF	Sluppet	Lukket	
Kanal 2 defekt (kanal 1 OK)	Blinker	OFF	ON	Sluppet	Lukket	
Kanal 1, signal OK	Blinker	OFF	OFF	Trukket	Åben	
Kanal 1, kabelkortslutning / kabelbrud	Blinker	Blinker	OFF	Sluppet	Lukket (hvis aktiveret)	
Kanal 2, signal OK	Blinker	OFF	OFF	Trukket	Åben	
Kanal 2, kabelkortslutning / kabelbrud	Blinker	OFF	Blinker	Sluppet	Lukket (hvis aktiveret)	



# PROGRAMMERING / BETJENING AF TRYKKNAPPER

Dokumentation til rutediagram

## Generelt

Når du skal konfigurere 9113, bliver du guidet igennem samtlige parametre og kan vælge netop de indstillinger, der passer til applikationen. Til hver menu findes en rullende hjælpepetekst, som vises i displaylinie 3.

Konfigurationen udføres ved hjælp af de 3 taster:

-  forøger talværdien eller vælger næste parameter
-  formindsker talværdien eller vælger forrige parameter
-  accepterer valget og går til næste menu

Når konfigurationen er gennemført, returneres til normaltilstand 1.0.

Tryk og hold  tasten nede for at gå til forrige menu eller normaltilstand (1.0) uden at gemme de ændrede tal eller parametre.

Hvis ingen taster har været aktiveret i 1 minut, returnerer displayet til normaltilstand (1.0) uden at gemme de ændrede tal eller parametre.

## Uddybende forklaringer

**Passwordbeskyttelse:** Programmeringsadgang kan forhindres ved indkodning af et password. Passwordet gemmes i konverteren, så sikkerheden mod uønskede ændringer er så høj som muligt. Default password 2008 giver adgang til alle programmeringsmenuer.

## Valg af units

Ved valg af temperaturindgang kan man vælge, hvilke procesenheder der skal vises i displayet (se skema). Procesværdien altid i Celsius eller Fahrenheit.

Vælges i menupunktet efter valg af temperaturindgang.

## CJC

Det er via menuen CJC muligt at vælge mellem ekstern CJC-klemme, og intern CJC-kompensering. CJC-klemme (PR 5910Ex/PR 5913Ex) bestilles særskilt.

## Signal- og følerfejlsinformation via displayfront 4501

Følerfejl (se grænser i skema) vises i display med SE.BR (sensor break) eller SE.SH (sensor short). Signaler uden for det valgte område (ikke følerfejl, se skema for grænser) vises i display som IN.LO (lavt indgangssignal) eller IN.HI (højt indgangssignal). Fejlindikeringen vises i tekst i 2. linie for kanal 1 og 3.

linie for kanal 2, samtidig med at baggrundsbelysningen blinker. 4. linie i displayet er en statuslinie, der viser, om modulet er SIL-låst (statisk prik = SIL-låst og blinkende prik = ikke SIL-låst) og status for kommunikation COM (prik med løbende cirkel) som indikerer, om 4501 fungerer korrekt.

## Signal- og følerfejlsindikering uden displayfront:

Status på enheden kan aflæses på de 3 LED's i fronten af modulet.

Grøn blinkende LED indikerer normal drift.

Ingen lys i grøn LED indikerer manglende forsyningsspænding eller modulfejl.

Konstant rød LED indikerer fatal fejl.

Rød blinkende LED indikerer følerfejl.

## Avancerede funktioner

Enheden giver adgang til en række avancerede funktioner, der nås ved at svare "YES" til punktet "ADV.SET".

**Display setup:** Her kan man justere kontrast og baggrundsbelysning.

Opsætning af TAG-nummer med 5 alfanumeriske karakterer. Valg af funktionsvisning i linie 2 og 3 på displayet, der vælges mellem visning af analog indgang, analog udgang og TAG-nummer eller vekslende displayvisning.

**2-punkts proceskalibrering:** Enheden kan proceskalibreres til et aktuelt indgangssignal i 2 punkter. Der påtrykkes et lavt indgangssignal (ikke nødvendigvis 0%), og den aktuelle værdi angives. Herefter påtrykkes et højt signal (ikke nødvendigvis 100%), og den aktuelle værdi angives. Såfremt man siger ja til at bruge kalibreringen, vil enheden herefter arbejde i henhold til denne nye justering. Siger man senere nej i dette punkt eller vælger en anden indgangssignaltyp, går enheden tilbage til fabrikskalibreringen.

**Processimulerings-funktion:** Vælger man ja til punktet "EN.SIM", er det muligt med piltasterne at simulere et indgangssignal og dermed styre udgangssignalet op og ned. SIM-menuen skal forlades ved at trykke  (ingen time-out). Hvis 4501 fjernes, afbrydes processimuleringen.

**Password:** Her kan vælges et password mellem 0000 og 9999 til beskyttelse mod uautoriserede ændringer. Enheden leveres default uden password.

**Sprog:** Der kan i menuen "LANG" vælges mellem 7 forskellige sprogvarianter af hjælpetekster, der fremkommer i menuen. Der kan vælges mellem UK, DE, FR, IT, ES, SE og DK.

**Power rail:** I menuen "RAIL" vælges om følerfejl skal overføres til en central overvågning i PR 9410 power control unit.

**Safety Integrity Level:** Se Safety Manual for yderligere information.



# RUTEDIAGRAM

**Power up** Hvis ingen taster har været aktiveret i 1 minut, returnerer displayet til normaltilstanden 1.0 uden at gemme eventuelle konfigurationsændringer.

- ⤴ Forøgelse af værdi / vælg næste parameter
- ⤵ Formindskelse af værdi / vælg forrige parameter
- OK Accepter valget og gå til næste menu

Holde OK går til forrige menu / returnerer til 1.0 uden at gemme



- 1.0 = Normaltilstand. Linie 1 viser indgangsstatus. linie 2 og 3 (3,33 mm høje) viser analog indgangs- / udgangsværdi eller TAG-nr. samt enheder - UNIT, og linie 4 viser status for kommunikation og SIL-lås. Statisk prik = SIL-låst og blinkende prik = ikke SIL-låst.
- 1.1 = Kun hvis beskyttet med password
- 1.2 = Gælder ikke for 0...20 mA indgangssignal.
- 1.3 = Kun hvis indgangssignalet er temperatur. Min. og max. iht. valgt følerstype.
- 1.4 = Kun hvis opsætning ikke er beskyttet med password.

**Rød tekst** viser safety parametre i en SIL-konfiguration. Se Safety Manual for yderligere information.

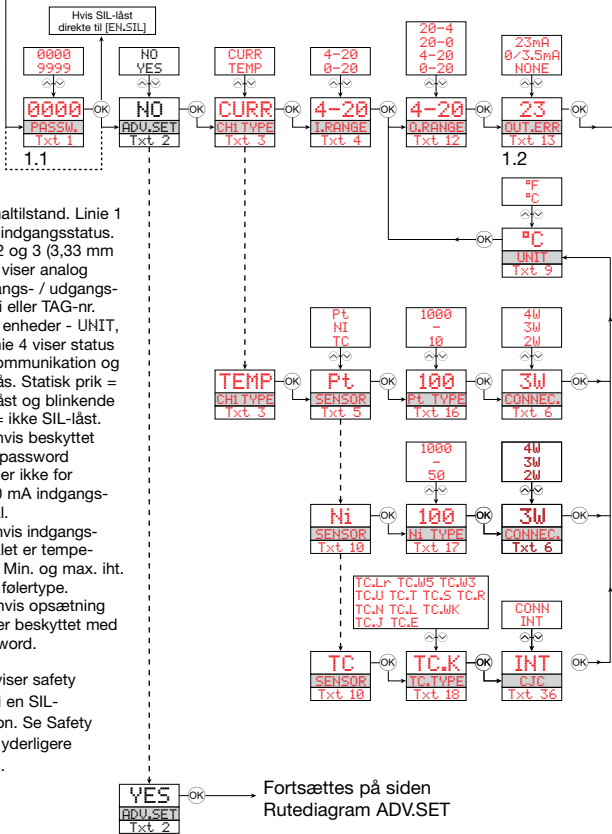

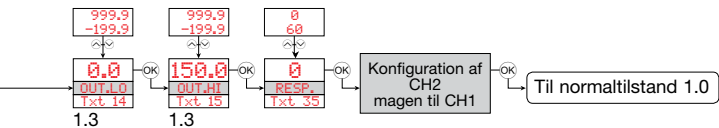



# RULLENDE HJÆLPETEKSTER I DISPLAYLINIE 3

- [01] Angiv korrekt password
- [02] Gå til avanceret opsætningsmenu?
- [03] Vælg temperaturindgang  
Vælg strømindgang
- [04] Vælg 0-20 mA indgangsområde  
Vælg 4-20 mA indgangsområde
- [05] Vælg TC-følertype  
Vælg Ni-følertype  
Vælg Pt-følertype
- [06] Vælg Pt10 som følertype  
Vælg Pt20 som følertype  
Vælg Pt50 som følertype  
Vælg Pt100 som følertype  
Vælg Pt200 som følertype  
Vælg Pt250 som følertype  
Vælg Pt300 som følertype  
Vælg Pt400 som følertype  
Vælg Pt500 som følertype  
Vælg Pt1000 som følertype
- [07] Vælg Ni50 som følertype  
Vælg Ni100 som følertype  
Vælg Ni120 som følertype  
Vælg Ni1000 som følertype
- [08] Vælg TC-B som følertype  
Vælg TC-E som følertype  
Vælg TC-J som følertype  
Vælg TC-K som følertype  
Vælg TC-L som følertype  
Vælg TC-N som følertype  
Vælg TC-R som følertype  
Vælg TC-S som følertype  
Vælg TC-T som følertype  
Vælg TC-U som følertype  
Vælg TC-W3 som følertype  
Vælg TC-W5 som følertype  
Vælg TC-LR som følertype
- [09] Vælg 2-leder følertilslutning  
Vælg 3-leder følertilslutning  
Vælg 4-leder følertilslutning
- [11] Vælg Celsius som temperaturenhed  
Vælg Fahrenheit som temperaturenhed
- [12] Vælg 0-20 mA udgangsområde  
Vælg 4-20 mA udgangsområde  
Vælg 20-0 mA udgangsområde  
Vælg 20-4 mA udgangsområde
- [13] Vælg ingen fejlaktion - udgang undefineret ved fejl  
Vælg downscale ved fejl  
Vælg NAMUR NE43 downscale ved fejl  
Vælg NAMUR NE43 upscale ved fejl
- [14] Indstil temperatur for analog udgang lav
- [15] Indstil temperatur for analog udgang høj
- [16] Vælg om fejl skal sendes til Rail
- [17] Gå til valg af SIL-låsning  
Gå til valg af SIL-tilstand  
Gå til valg af fejl til RAIL  
Udfør proceskalibrering  
Gå til valg af sprog  
Gå til password-indstilling  
Gå til displayopsætning  
Udfør memory-operationer
- [18] Overfør gemt opsætning til 9113  
Gem 9113-opsætning i 4501
- [19] Juster LCD-kontrast
- [20] Juster LCD-baggrundsbelysning
- [21] Angiv TAG-nr. - udfyld alle pladser
- [22] Analog indgangsværdi vises i display  
Analog udgangsværdi vises i display  
TAG-nr. vises i display  
Skift displayvisning mellem analogværdi og tag
- [23] Vælg passwordbeskyttelse?
- [24] Angiv nyt password
- [25] Vælg sprog
- [26] Vælg kanal for proceskalibrering
- [27] Kalibrer indgang lav til procesværdi?
- [28] Indstil værdi for lavt kalibreringspunkt
- [29] Kalibrer indgang høj til procesværdi?
- [30] Indstil værdi for højt kalibreringspunkt
- [31] Brug proceskalibreringsværdier?
- [32] Vælg kanal til simulering
- [33] Indstil simuleringsværdi for indgang
- [34] Vælg at SIL-låse konfigurationen  
0-20 mA er ikke gyldigt udgangsområde for drift i SIL-låst tilstand
- [35] Vælg responstid for analog udgang i sekunder
- [36] Vælg Intern temperatur-føler  
Vælg CJC-stik (tilbehør)
- [37] ...Bruger kanalen proceskompenserede kalibreringsdata?
- [38] Konfigurationens SIL-status (åben / låst)
- [40] Følerkabelbrud
- [41] Følerkortslutning
- [42] Indgang uden for min.-område
- [43] Indgang uden for max.-område
- [44] Fejl på indgang - kontroller indgangsforbindelser og genstart enheden
- [45] Fejl på udgang - kontroller udgangsforbindelser og genstart enheden
- [46] Fejl i FLASH - kontroller konfiguration
- [47] Ugyldig konfiguration eller ugyldig version
- [48] Hardware fejl
- [49] CJC-følerfejl - kontroller enhedens temperatur
- [50] CJC-følerfejl - kontroller CJC-stikterminal
- [51] Ingen kommunikation

# TEMPERATURE / mA CONVERTER

## 9113

### CONTENTS

Warning .....	26
Symbol identification.....	26
Safety instructions.....	26
How to demount system 9000.....	28
EC declaration of conformity .....	29
Advanced features .....	30
Application .....	30
Technical characteristics .....	30
Applications.....	31
PR 4501 display / programming front.....	32
Order .....	33
Electrical specifications.....	33
Configuration of sensor error check .....	38
Visualisation in the 4501 of:	
Input signal outside range.....	38
Sensor error detection .....	38
Error indications .....	38
Connections .....	40
Block diagram .....	41
Signal error and cable fault indications without display front.....	42
Configuration / operating the function keys .....	43
Routing diagram.....	46
Routing diagram, Advanced settings (ADV.SET).....	48
Scrolling help texts in display line 3.....	49
Appendix .....	102
IECEx Installation Drawing .....	103
ATEX Installation Drawings, UK, FR, DE, DK.....	106
FM Installation Drawing.....	118
Safety Manual .....	121



## WARNING

The following operations should only be carried out on a disconnected device and under ESD-safe conditions:

- General mounting, connection and disconnection of wires.
- Troubleshooting the device.

**Repair of the device and replacement of circuit breakers must be done by PR electronics A/S only.**



## WARNING

Do not open the front plate of the device as this will cause damage to the connector for the display / programming front PR 4501. This device contains no DIP-switches or jumpers.

## SYMBOL IDENTIFICATION



**Triangle with an exclamation mark:** Read the manual before installation and commissioning of the device in order to avoid incidents that could lead to personal injury or mechanical damage.



**The CE mark** proves the compliance of the device with the essential requirements of the directives.



**The double insulation symbol** shows that the device is protected by double or reinforced insulation.



**Ex devices** have been approved according to the ATEX directive for use in connection with installations in explosive areas.

## SAFETY INSTRUCTIONS

### DEFINITIONS

**Hazardous voltages** have been defined as the ranges: 75...1500 Volt DC, and 50...1000 Volt AC.

**Technicians** are qualified persons educated or trained to mount, operate, and also troubleshoot technically correct and in accordance with safety regulations.

**Operators**, being familiar with the contents of this manual, adjust and operate the knobs or potentiometers during normal operation.

## **RECEIPT AND UNPACKING**

Unpack the device without damaging it. The packing should always follow the device until this has been permanently mounted.

Check at the receipt of the device whether the type corresponds to the one ordered.

## **ENVIRONMENT**

Avoid direct sunlight, dust, high temperatures, mechanical vibrations and shock, as well as rain and heavy moisture. If necessary, heating in excess of the stated limits for ambient temperatures should be avoided by way of ventilation.

The device must be installed in pollution degree 2 or better.

The device is designed to be safe at least under an altitude up to 2 000 m.

## **MOUNTING**

Only technicians who are familiar with the technical terms, warnings, and instructions in the manual and who are able to follow these should connect the device.

Should there be any doubt as to the correct handling of the device, please contact your local distributor or, alternatively,

**PR electronics A/S, Lerbakken 10, 8410 Rønde, Danmark tlf: +45 86 37 26 77.**

The use of stranded wires is not permitted for mains wiring except when wires are fitted with cable ends.

Descriptions of input / output and supply connections are shown in the block diagram and on the side label.

The device is provided with field wiring terminals and shall be supplied from a Power Supply having double / reinforced insulation. A power switch shall be easily accessible and close to the device. The power switch shall be marked as the disconnecting device for the device.

For installation on Power Rail 9400 the power is supplied by Power Control module 9410.

Year of manufacture can be taken from the first two digits in the serial number.

## **CALIBRATION AND ADJUSTMENT**

During calibration and adjustment, the measuring and connection of external voltages must be carried out according to the specifications of this manual. The technician must use tools and instruments that are safe to use.

## **NORMAL OPERATION**

Operators are only allowed to adjust and operate device that are safely fixed in panels, etc., thus avoiding the danger of personal injury and damage. This means there is no electrical shock hazard, and the device is easily accessible.

## **CLEANING**

When disconnected, the device may be cleaned with a cloth moistened with distilled water.

## **LIABILITY**

To the extent the instructions in this manual are not strictly observed, the customer cannot advance a demand against PR electronics A/S that would otherwise exist according to the concluded sales agreement.

# **HOW TO DEMOUNT SYSTEM 9000**

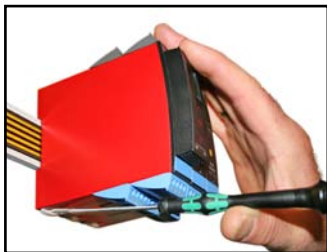

**Picture 1:**

By lifting the bottom lock, the device is detached from the DIN rail.

# EC DECLARATION OF CONFORMITY

As manufacturer

**PR electronics A/S**  
**Lerbakken 10**  
**DK-8410 Rønde**

hereby declares that the following product:

**Type: 9113**  
**Name: Temperature / mA converter**

is in conformity with the following directives and standards:

The EMC Directive 2004/108/EC and later amendments

**EN 61326-1 : 2006**

For specification of the acceptable EMC performance level, refer to the electrical specifications for the device.

The Low Voltage Directive 2006/95/EC and later amendments

**EN 61010-1 : 2001**

The ATEX Directive 94/9/EC and later amendments

**EN 61241-0:2006, EN 61241-11:2006, EN 60079-0:2006,**  
**EN 60079-11:2007, EN 60079-15:2005, EN 60079-26:2007**  
**ATEX certificate: KEMA 07ATEX0148 X**

Notified body

**KEMA Quality B.V. (0344)**  
**Utrechtseweg 310, 6812 AR Arnhem**  
**P.O. Box 5185, 6802 ED Arnhem**  
**The Netherlands**

Rønde, 24 September 2009

---

Kim Rasmussen  
Manufacturer's signature

# TEMPERATURE / mA CONVERTER

## 9113

- *Input for RTD, TC and mA*
- *Active / passive mA output*
- *1 or 2 channels*
- *Can be supplied separately or installed on power rail, PR type 9400*
- *SIL 2-certified via Full Assessment*

### Advanced features

- Configuration and monitoring by way of detachable display front (PR 4501); process calibration and signal simulation.
- Copying of the configuration from one device to others of the same type via the display front.
- TC inputs can use either the internal CJC or a terminal with a built-in Pt100 sensor (PR 5910Ex, channel 1 / PR 5913Ex, channel 2) for higher accuracy.
- The device automatically detects whether it must supply an active or a passive current signal.
- Advanced monitoring of internal communication and stored data.
- SIL 2 functionality is optional and must be activated in a menu point.

### Application

- The device can be mounted in the safe area and in zone 2 / div. 2 and receive signals from zone 0, 1, 2, 20, 21 and 22 / Class I/II/III, Div. 1, Gr. A-G.
- Conversion and scaling of temperature (Pt, Ni and TC) and active current signals.
- The 9113 has been designed, developed and certified for use in SIL 2 applications according to the requirements of IEC 61508.

### Technical characteristics

- 1 green and 2 red front LEDs indicate operation status and malfunction.
- 2.6 kVAC galvanic isolation between input, output and supply.

# APPLICATIONS

## Input signals:

Channel 1:

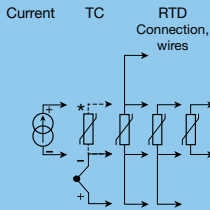

\*Order separately: CJC connector 5910Ex/5913Ex

Channel 2:

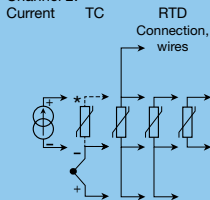

\*Order separately: CJC connector 5910Ex/5913Ex

**Zone 0, 1, 2,  
20, 21, 22 /  
Cl. I/II/III, div. 1  
gr. A-G**

## Output signals:

Analogue, 0/4...20 mA

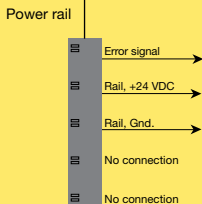
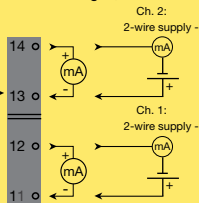

## Power connection:

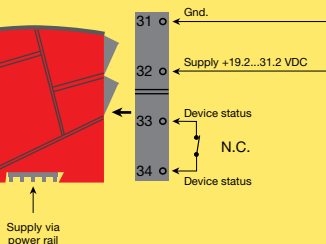

**Zone 2 / Cl. 1, div. 2, gr. A-D or safe area**

## PR 4501 DISPLAY / PROGRAMMING FRONT



### Functionality

The simple and easily understandable menu structure and the explanatory help texts guide you effortlessly and automatically through the configuration steps, thus making the product very easy to use. Functions and configuration options are described in the section "Configuration / operating the function keys".

### Application

- Communications interface for modification of operational parameters in 9113.
- Can be moved from one 9113 device to another and download the configuration of the first unit to subsequent units.
- When mounted in the process, the display shows process values and device status.

### Technical characteristics

- LCD display with 4 lines; Line 1 (H=5.57 mm) shows input status, line 2 and 3 (H=3.33 mm) show analogue input / output value or TAG no. and units, and line 4 shows status for communication and whether the device is SIL-locked. Static dot = SIL-locked and flashing dot = not SIL-locked.
- Programming access can be blocked by assigning a password. The password is saved in the device in order to ensure a high degree of protection against unauthorised modifications to the configuration.

### Mounting / installation

- Click 4501 onto the front of 9113.

## Order

<b>9113BA</b>	=	<b>Temperature / mA converter, 1 channel</b>
<b>9113BB</b>	=	<b>Temperature / mA converter, 2 channels</b>
<b>4501</b>	=	<b>Display / programming front</b>
<b>5910Ex</b>	=	<b>CJC connector, channel 1</b>
<b>5913Ex</b>	=	<b>CJC connector, channel 2</b>
<b>9400</b>	=	<b>Power rail</b>

## Electrical specifications

Specifications range.....	-20°C to +60°C
Storage temperature .....	-20°C to +85°C

### Common specifications:

Supply voltage, DC .....	19.2...31.2 VDC
Max. consumption.....	≤ 3.5 W (2 channels)
Fuse.....	400 mA SB / 250 VAC
Isolation voltage, test / operation:	
Input / output / supply .....	2.6 kVAC / 250 VAC
Output 1 to output 2 .....	1.5 kVAC / 150 VAC reinforced
Status relay to supply .....	1.5 kVAC / 150 VAC reinforced
Communications interface .....	Programming front 4501
Signal / noise ratio .....	Min. 60 dB (0...100 kHz)
Average response time incl. delay:	
Temperature input .....	≤ 1 s
mA input.....	≤ 0.4 s
Calibration temperature.....	20...28°C

Accuracy, the greater of the general and basic values:

<b>General values</b>		
Input type	Absolute accuracy	Temperature coefficient
All	$\leq \pm 0.1\%$ of span	$\leq \pm 0.01\%$ of span / °C

<b>Basic values</b>		
Input type	Basic accuracy	Temperature coefficient
mA	$\leq \pm 16 \mu\text{A}$	$\leq \pm 1.6 \mu\text{A} / ^\circ\text{C}$
Pt100, Pt200, Pt 1000	$\leq \pm 0.2^\circ\text{C}$	$\leq \pm 0.02^\circ\text{C} / ^\circ\text{C}$
Pt500, Ni100, Ni120, Ni 1000	$\leq \pm 0.3^\circ\text{C}$	$\leq \pm 0.03^\circ\text{C} / ^\circ\text{C}$
Pt50, Pt400, Ni50	$\leq \pm 0.4^\circ\text{C}$	$\leq \pm 0.04^\circ\text{C} / ^\circ\text{C}$
Pt250, Pt300	$\leq \pm 0.6^\circ\text{C}$	$\leq \pm 0.06^\circ\text{C} / ^\circ\text{C}$
Pt20	$\leq \pm 0.8^\circ\text{C}$	$\leq \pm 0.08^\circ\text{C} / ^\circ\text{C}$
Pt10	$\leq \pm 1.4^\circ\text{C}$	$\leq \pm 0.14^\circ\text{C} / ^\circ\text{C}$
TC type: E, J, K, L, N, T, U	$\leq \pm 1^\circ\text{C}$	$\leq \pm 0.1^\circ\text{C} / ^\circ\text{C}$
TC type: R, S, W3, W5, LR	$\leq \pm 2^\circ\text{C}$	$\leq \pm 0.2^\circ\text{C} / ^\circ\text{C}$
TC type: B 160...400°C	$\leq \pm 4.5^\circ\text{C}$	$\leq \pm 0.45^\circ\text{C} / ^\circ\text{C}$
TC type: B 400...1820°C	$\leq \pm 2^\circ\text{C}$	$\leq \pm 0.2^\circ\text{C} / ^\circ\text{C}$

EMC immunity influence .....	$< \pm 0.5\%$ of span
Extended EMC immunity: NAMUR NE 21, A criterion, burst .....	$< \pm 1\%$ of span

Wire size (min....max.) ..... AWG 14...26 / 0.13...2.08 mm<sup>2</sup>  
stranded wire

Screw terminal torque ..... 0.5 Nm

Relative humidity .....  $< 95\%$  RH (non-cond.)

Dimen., without display front (HxBxD) ..... 109 x 23.5 x 104 mm

Dimensions, w. display front (HxBxD) ..... 109 x 23.5 x 116 mm

Protection degree..... IP20  
 Weight ..... 250 g / 265 g with 4501

**Isolation:**

Input to any ..... 300 VAC double/reinforced isolation  
 Analogue output to supply..... 300 VAC double/reinforced isolation  
 Status relay to supply ..... 150 VAC double/reinforced or  
 300 VAC basic isolation

**RTD input:**

Input type	Min. value	Max. value	Standard
Pt100 Ni100	-200°C -60°C	+850°C +250°C	IEC60751 DIN 43760

Input for RTD types:

Pt10\*, Pt20\*, Pt50\*, Pt100, Pt200, Pt250, Pt300, Pt400, Pt500, Pt1000  
 Ni50, Ni100, Ni120, Ni1000

Cable resistance per wire (max.)..... 50 Ω  
 Sensor current..... Nom. 0.2 mA  
 Effect of sensor cable resistance  
 (3- / 4-wire)..... < 0.002 Ω / Ω  
 Sensor error detection ..... Programmable ON / OFF  
 Sensor error current:  
 when detecting..... < 2 µA  
 else..... 0 µA

\* No short circuit detection for Pt10, Pt20 and Pt50

**TC input:**

Type	Min. value	Max. value	Standard
B	+0°C	+1820°C	IEC 60584-1
E	-100°C	+1000°C	IEC 60584-1
J	-100°C	+1200°C	IEC 60584-1
K	-180°C	+1372°C	IEC 60584-1
L	-200°C	+900°C	DIN 43710
N	-180°C	+1300°C	IEC 60584-1
R	-50°C	+1760°C	IEC 60584-1
S	-50°C	+1760°C	IEC 60584-1
T	-200°C	+400°C	IEC 60584-1
U	-200°C	+600°C	DIN 43710
W3	0°C	+2300°C	ASTM E988-90
W5	0°C	+2300°C	ASTM E988-90
LR	-200°C	+800°C	GOST 3044-84

### Cold junction compensation (CJC):

- via external sensor in connector 5910.... 20...28°C ≤ ±1°C  
-20...20°C and 28...70°C ≤ ±2°C
- via internal CJC sensor..... ±(2.0°C + 0.4°C \* Δt)

Δt = internal temperature - ambient temperature

Sensor error detection ..... Programmable ON or OFF  
(only wire breakage)

### Sensor error current:

- when detecting..... Nom. 2 μA
- else..... 0 μA

### Current input:

- Measurement range ..... 0...20 mA
- Programmable measurement ranges..... 0...20 and 4...20 mA
- Input resistance..... Nom. 20 Ω + PTC 50 Ω
- Sensor error detection ..... Programmable ON / OFF  
Only 4...20 mA (NAMUR)

### Current output:

- Signal range (span)..... 0...20 mA
- Programmable signal ranges ..... 0...20 / 4...20 /  
20...0 and 20...4 mA
- Load (max.)..... 20 mA / 600 Ω / 12 VDC
- Load stability..... ≤ 0.01% of span / 100 Ω
- Sensor error detection ..... 0 / 3.5 / 23 mA / none
- NAMUR NE 43 Upscale/Downscale ..... 23 mA / 3.5 mA
- Output limitation:
  - on 4...20 and 20...4 mA signals ..... 3.8...20.5 mA
  - on 0...20 and 20...0 mA signals ..... 0...20.5 mA
- Current limit..... ≤ 28 mA

### 2-wire 4...20 mA output:

- Signal range ..... 4...20 mA
- Load stability..... ≤ 0.01% of span / 100 Ω
- Load resistance..... ≤ (V<sub>supply</sub> - 3.5) / 0.023 A [Ω]
- External 2-wire supply range ..... 3.5...26 VDC
- Effect of external 2-wire supply  
voltage variation..... < 0.005% of span / V

### Status relay in safe area:

- Max. voltage..... 125 VAC / 110 VDC
- Max. current ..... 0.5 AAC / 0.3 ADC
- Max. AC power ..... 62.5 VA / 32 W

### Marine approval:

- Det Norske Veritas, Ships & Offshore ..... Pending

**GOST R approval:**VNIIFTRI, Cert No..... See [www.preelectronics.com](http://www.preelectronics.com)**SIL certification:**

exida, Cert No. .... PREI 070902 P0002 C03.01

**Observed authority requirements:****Standard:**

EMC 2004/108/EC ..... EN 61326-1

LVD 2006/95/EC ..... EN 61010-1

ATEX 94/9/EC ..... EN 60079-0, -11, -15, -26  
and EN 61241-0, -11IECEX ..... IEC 60079-0, -11, -15 and -26  
IEC 61241-0 and -11

c FM us ..... FM 3600, 3611, 3810

CSA E60079-0, -15

CSA 22.2 -25, -142, -213

ANSI/ISA-12.00.01 / 12.12.02

UL, Standard for Safety ..... UL 61010-1

SIL ..... IEC 61508

**of span** = of the currently selected measurement range

## Configuration of sensor error check

Sensor error check:		
Device:	Configuration	Sensor error detection:
9113	OUT.ERR=NONE.	OFF
	Else:	ON

## Visualisation in the 4501 of: Input signal outside range

Outside range readout (IN.LO, IN.HI): If the valid range of the A/D converter or the polynomial is exceeded			
Input	Range	Readout	Limit
CURR	0...20 mA / 4...20 mA	IN.LO	< -1.05 mA
		IN.HI	> 25.05 mA
TEMP	TC / RTD	IN.LO	< temperature range -2°C
		IN.HI	> temperature range +2°C

Display readout below min. / above max. (-1999, 9999):			
Input	Range	Readout	Limit
All	All	-1999	Display readout <-1999
		9999	Display readout >9999

## Sensor error detection

Sensor error detection (SE.BR, SE.SH):			
Input	Range	Readout	Limit
CURR	Loop break (4...20 mA)	SE.BR	<= 3.6 mA; >= 20.75 mA
TEMP	TC	SE.BR	> 10 kΩ...165 kΩ
		SE.SH	< app. 15 Ω
	RTD: 2-, 3- and 4-wire For Pt10, Pt20, Pt50, Pt100, Pt200, Ni50 and Ni120	SE.BR	> 900...1000 Ω (cable > 50 Ω)
		SE.SH	< app. 15 Ω
		SE.BR	> 10...12 kΩ (cable > 50 Ω)
RTD: 2-, 3- and 4-wire for Pt250, Pt300, Pt400, Pt500, Pt1000 and Ni1000	SE.BR	> 10...12 kΩ (cable > 50 Ω)	
	SE.SH	< app. 15 Ω	

## Error indications

Readout at hardware error		
Error search	Readout	Cause
Input underrange	IN.LO	See conditions above
Input overrange	IN.HI	See conditions above
Sensor wire breakage	SE.BR	See conditions above
Sensor short circuit	SE.SH	See conditions above
Test of internal CJC sensor	CJ.ER	Internal CJC sensor defect or CJC temperature out of range**
CJC connector error - check CJC-connector block	CJ.CE	Defect or missing CJC-connector, temperature out of allowed range

Readout at hardware error		
Error search	Readout	Cause
Input error - check input connection and reset power	IN.ER	Signal levels on input beyond limits or connected to wrong terminals*
Output error - check output connections and reset power	AO.ER	Error in analogue output current (SIL mode only)*
No communication	NO.CO	No communication with (4501)
Flash memory error - check configuration	FL.ER CO.ER	FLASH error (configuration invalid)***
Invalid configuration type or version	TY.ER	Configuration read from EEprom has invalid type or rev. no.
Hardware error	RA.ER	RAM error*
Hardware error	IF.ER	Internal Flash error*
Hardware error	SW.ER	SW monitor error*
Hardware error	AD.ER	A/D converter error*
Hardware error	AO.SU	Analogue output supply error*
Hardware error	CA.ER	Factory calibration error*
Hardware error	CM.ER	Main CPU error*
Hardware error	II.ER	Initialisation check error*
Hardware error	RS.ER	Reset error*
Hardware error	IC.ER	Input communication error*
Hardware error	M1.ER	Main CPU to Ch.1 error*
Hardware error	M2.ER	Main CPU to Ch.2 error*
Hardware error	MC.ER	Main CPU config. error*
Hardware error	MF.ER	Main CPU Flash error*
Hardware error	MR.ER	Main CPU RAM error*
Hardware error	MS.ER	Main CPU supply error*
Hardware error	MP.ER	Main CPU ProgFlow error*

! All error indications in the display flash once per second. The help text explains the error.

\* Error is acknowledged by either stepping through the basic setup, or by resetting the device power. Some types of errors can only be acknowledged by resetting the device power.

\*\* Error is acknowledged by either stepping through the basic setup, or by resetting the device power. Error can be disregarded by selecting input type different than TC.

\*\*\* Error is acknowledged by stepping through the basic setup.

# CONNECTIONS

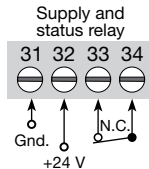
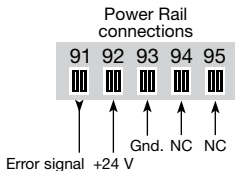

NC = no connection

## Inputs

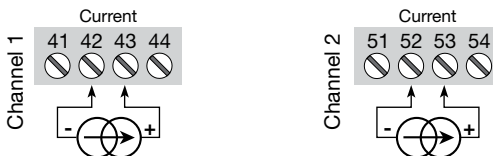
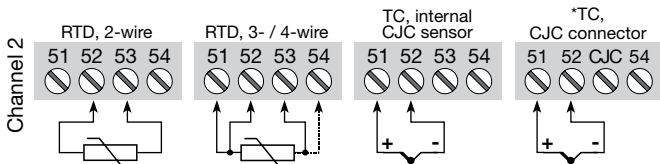
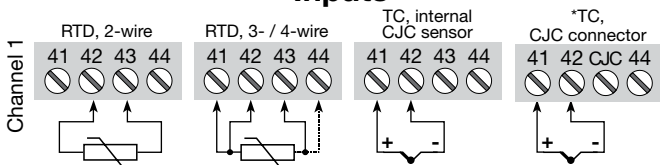

\* Order separately:  
CJC connector  
5910Ex (ch. 1) /  
5913Ex (ch. 2).

## Outputs

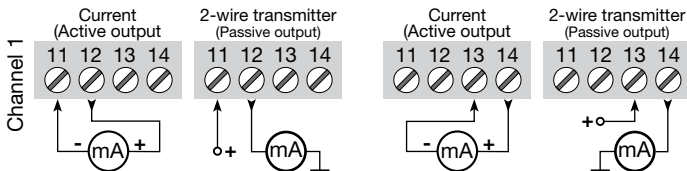

# BLOCK DIAGRAM

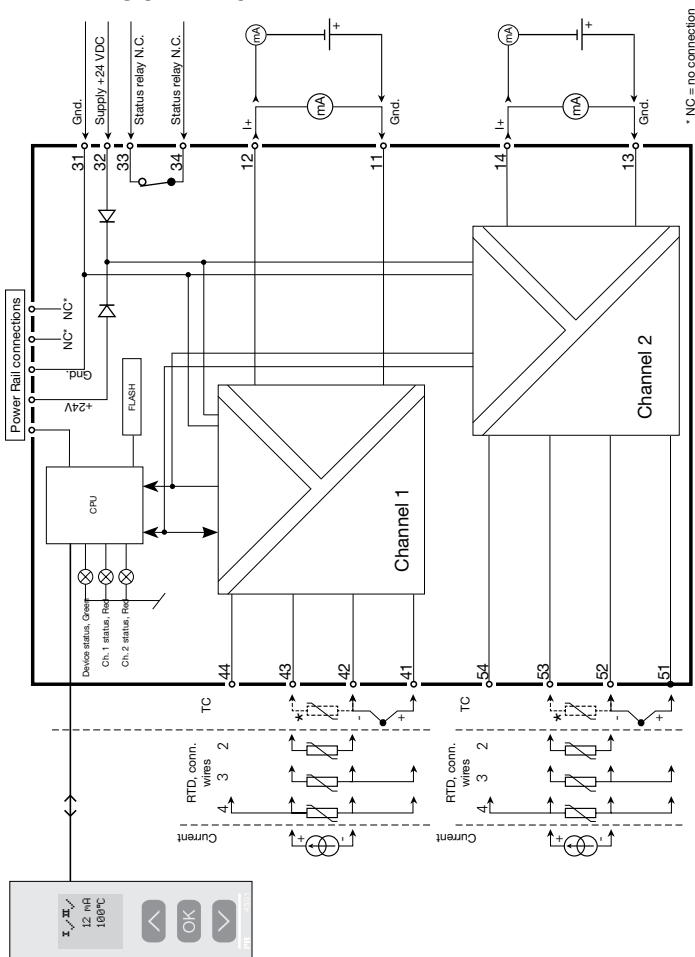

\* NC = no connection

# 9113

## Signal error and cable fault indications without display front

List of LED and error signal indications					
Condition	Green LED	Ch. 1: Red LED	Ch. 2: Red LED	Status relay, N.C.	Power rail signal status
Device OK	Flashing	OFF	OFF	Energized	Open
No supply	OFF	OFF	OFF	De-energized	Closed
Device defective	OFF	ON	ON	De-energized	Closed
Ch. 1 defective (ch. 2 OK)	Flashing	ON	OFF	De-energized	Closed
Ch. 2 defective (ch. 1 OK)	Flashing	OFF	ON	De-energized	Closed
Channel 1, signal OK	Flashing	OFF	OFF	Energized	Open
Ch. 1, wire short / break	Flashing	Flashing	OFF	De-energized	Closed (if activated)
Channel 2, signal OK	Flashing	OFF	OFF	Energized	Open
Ch. 2, wire short / break	Flashing	OFF	Flashing	De-energized	Closed (if activated)



# CONFIGURATION / OPERATING THE FUNCTION KEYS

Documentation for routing diagram.

## In general

When configuring the 9113, you will be guided through all parameters and you can choose the settings which fit the application. For each menu there is a scrolling help text which is automatically shown in line 3 on the display.

Configuration is carried out by use of the 3 function keys:

-  will increase the numerical value or choose the next parameter
-  will decrease the numerical value or choose the previous parameter
-  will accept the chosen value and proceed to the next menu

When configuration is completed, the display will return to the default state 1.0.

Pressing and holding  will return to the previous menu or return to the default state (1.0) without saving the changed values or parameters.

If no key is activated for 1 minute, the display will return to the default state (1.0) without saving the changed values or parameters.

## Further explanations

**Password protection:** Programming access can be blocked by assigning a password. The password is saved in the converter in order to ensure a high degree of protection against unauthorised modifications to the configuration. Default password 2008 allows access to all configuration menus.

## Selection of units

By selection of temperature input you can choose which process units should be shown in the display (see table). The process value is always displayed in Celsius or Fahrenheit. This is selected in the menu point after selection of temperature input.

## CJC

In the CJC menu you can choose between CJC connector and internal cold junction compensation. The CJC connector (PR 5910Ex/PR 5913Ex) must be ordered separately.

## Signal and sensor error information via display front 4501

Sensor error (see limits in the table) is displayed as SE.BR (sensor break) or SE.SH (sensor short). Signals outside the selected range (not sensor error, see table for limits) are displayed as IN.LO indicating low input signal or IN.HI indicating high input signal. The error indication is displayed as text in line 2 for channel 1 and line 3 for channel 2 and at the same time the backlight flashes. Line 4 of the display is a status line which shows whether the device is SIL-locked (static dot = SIL-locked and flashing dot = not SIL-locked) as well as status for communication COM (running circle) indicating correct functioning of 4501.

## Signal and sensor error indication without display front

Status of the unit can also be read from the 3 LEDs in the front of the device.

Green flashing LED indicates normal operation.

No light in the green LED indicates lack of supply voltage or error in the device.

Steady red LED indicates fatal error.

Flashing red LED indicates sensor error.

## Advanced functions

The unit gives access to a number of advanced functions which can be reached by answering "YES" to the point "ADV.SET".

**Display setup:** Here you can adjust the brightness contrast and the backlight. Setup of TAG numbers with 5 alphanumeric. Selection of functional readout in line 2 and 3 of the display - choose between readout of analogue input, analogue output or tag no or alternating display.

**Two-point process calibration:** The device can be process-calibrated in 2 points to fit a given input signal. A low input signal (not necessarily 0%) is applied and the actual value is entered. Then a high signal (not necessarily 100%) is applied and the actual value is entered. If you accept to use the calibration, the device will work according to this new adjustment. If you later reject this menu point or choose another type of input signal the device will return to factory calibration.

**Process simulation function:** In the menu point "EN.SIM" it is possible to simulate an input signal by means of the arrow keys and thus control the output signal up or down. You must exit the menu by pressing ⓧ (no time-out). The simulation function exits automatically, if the 4501 is detached.

**Password:** Here you can choose a pass word between 0000 and 9999 in order to protect the device against unauthorised modifications to the configuration. The device is delivered default without password.

**Language:** In the menu "lang.setup" you can choose between 7 different language versions of help texts that will appear in the menu. You can choose between UK, DE, FR, IT, ES, SE and DK.

**Power rail:** In the menu "RAIL" you can choose if sensor errors are transmitted to the central surveillance in the PR 9410 power control unit.

**Safety integrity level:** See Safety Manual for details



# ROUTING DIAGRAM

Power up

If no key is activated for 1 minute, the display will return to the default state 1.0 without saving configuration changes.

⏪ Increase value / choose next parameter

⏩ Decrease value / choose previous parameter

⏹ Accept the chosen value and proceed to the next menu

⏪ Hold Back to previous menu / return to menu 1.0 without saving



If SIL-locked directly to EN.SIL

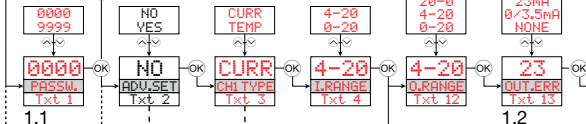

1.0 = Default state. Line 1 shows input status, line 2 and 3 show analogue input / output value or TAG No. and units, and line 4 shows status for communication and whether the device is SIL-locked. Static dot = SIL-locked and flashing dot = not SIL-locked.

1.1 = Only if password-protected.

1.2 = Not valid for 0...20 mA input signal.

1.3 = Only if input signal is temperature. Min. and max. acc. to selected sensor type.

1.4 = Only if the configuration is not protected by a password.

Red text signifies safety parameters in a SIL configuration. See safety manual for details

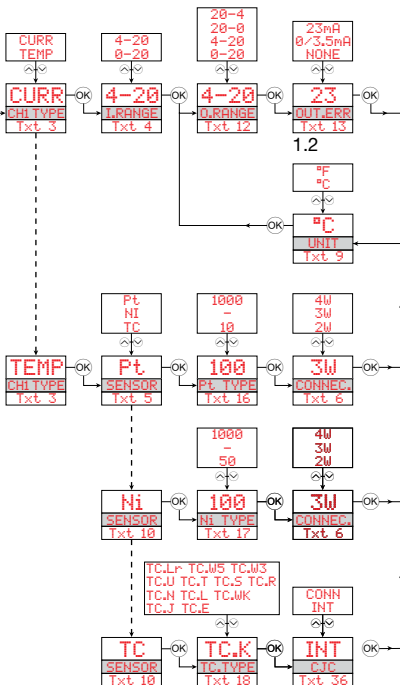

Continued on the page  
Routing diagram ADV.SET

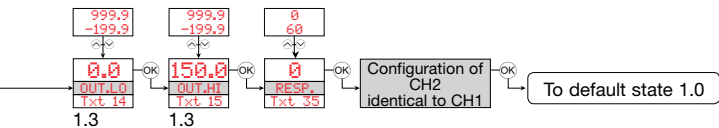

## ROUTING DIAGRAM, ADVANCED SETTINGS (ADV.SET)

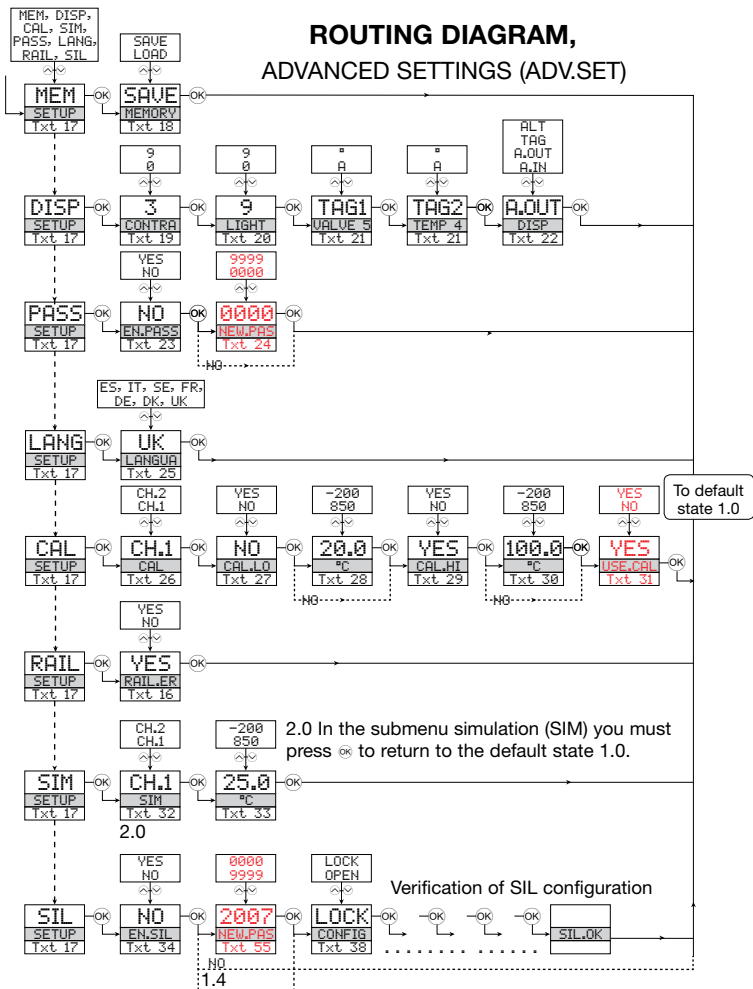

2.0 In the submenu simulation (SIM) you must press **OK** to return to the default state 1.0.

Verification of SIL configuration

## SCROLLING HELP TEXTS IN DISPLAY LINE 3

- [01] Set correct password
- [02] Enter advanced setup menu?
- [03] Select temperature input  
Select current input
- [04] Select 0-20 mA input range  
Select 4-20 mA input range
- [05] Select TC sensor type  
Select Ni sensor type  
Select Pt sensor type
- [06] Select Pt10 sensor type  
Select Pt20 sensor type  
Select Pt50 sensor type  
Select Pt100 sensor type  
Select Pt200 sensor type  
Select Pt250 sensor type  
Select Pt300 sensor type  
Select Pt400 sensor type  
Select Pt500 sensor type  
Select Pt1000 sensor type
- [07] Select Ni50 sensor type  
Select Ni100 sensor type  
Select Ni120 sensor type  
Select Ni1000 sensor type
- [08] Select TC-B sensor type  
Select TC-E sensor type  
Select TC-J sensor type  
Select TC-K sensor type  
Select TC-L sensor type  
Select TC-N sensor type  
Select TC-R sensor type  
Select TC-S sensor type  
Select TC-T sensor type  
Select TC-U sensor type  
Select TC-W3 sensor type  
Select TC-W5 sensor type  
Select TC-Lr sensor type
- [09] Select 2-wire sensor connection  
Select 3-wire sensor connection  
Select 4-wire sensor connection
- [11] Select Celsius as temperature unit  
Select Fahrenheit as temperature unit
- [12] Select 0-20 mA output range  
Select 4-20 mA output range  
Select 20-0 mA output range  
Select 20-4 mA output range
- [13] Select no error action - output undefined at error  
Select downscale at error  
Select NAMUR NE43 downscale at error  
Select NAMUR NE43 upscale at error
- [14] Set temperature for analogue output low
- [15] Set temperature for analogue output high
- [16] Enable Rail status signal output?
- [17] Enter SIL setup  
Enter simulation mode  
Enter RAIL setup  
Perform process calibration  
Enter language setup  
Enter password setup  
Enter display setup  
Perform memory operations
- [18] Load saved configuration into 9113  
Save 9113 configuration in 4501
- [19] Adjust LCD contrast
- [20] Adjust LCD backlight
- [21] Write a 5-character channel TAG
- [22] Show analogue input value in display  
Show analogue output value in display  
Show TAG in display  
Alternate shown information in display
- [23] Enable password protection?
- [24] Set new password
- [25] Select language
- [26] Select channel to calibrate
- [27] Calibrate input low to process value?
- [28] Set value for low calibration point
- [29] Calibrate input high to process value?
- [30] Set value for high calibration point
- [31] Use process calibration values?
- [32] Select channel to simulate
- [33] Set the input simulation value
- [34] Enable SIL configuration lock?  
0-20 mA is not a valid output range for SIL operation
- [35] Set Analog output response time in seconds
- [36] Select internal temperature sensor  
Select CJC connector (accessory)
- [37] ...is channel using process-compensated calibration data?
- [38] Configuration SIL status (Open / Locked)
- [40] Sensor wire breakage
- [41] Sensor short circuit
- [42] Input underrange
- [43] Input overrange
- [44] Input error - check input connections and reset power
- [45] Output error - check connections and reset power
- [46] Flash memory error - check configuration
- [47] Invalid configuration type or version
- [48] Hardware error
- [49] CJC sensor error - check device temperature
- [50] CJC error - check CJC connector block
- [51] No communication



# CONVERTISSEUR PROGRAMMABLE, [Ex ia]

## 9113

### SOMMAIRE

Avertissement.....	52
Signification des symboles .....	52
Consignes de sécurité .....	52
Démontage du système 9000 .....	54
Déclaration de conformité CE.....	55
Options avancées.....	56
Fonctions.....	56
Caractéristiques techniques.....	56
Applications.....	57
PR 4501 indicateur / façade de programmation.....	58
Références de commande .....	59
Spécifications.....	59
Configuration du contrôle d'erreur de câble.....	64
Indication dans le 4501 de:	
Signal d'entrée hors d'échelle.....	64
Détection erreur capteur .....	64
Indications erreurs matériels .....	64
Connexions .....	66
Schéma de principe .....	67
Indications d'erreur signal et câble sans la façade 4501 ..	68
Programmation / opération des touches de fonction.....	69
Diagramme de programmation .....	72
Diagramme de programmation, Reglage avance (ADV.SET).....	74
Menu déroulant en ligne 3 de l'indicateur.....	75
Appendix .....	102
IECEx Installation Drawing .....	103
ATEX Installation Drawings, UK, FR, DE, DK.....	106
FM Installation Drawing.....	118
Safety Manual .....	121



## AVERTISSEMENT

Les opérations suivantes doivent être effectuées avec le module débranché et dans un environnement exempt de décharges électrostatiques (ESD): montage général, raccordement et débranchement de fils et recherche de pannes sur le module.

**Seule PR electronics SARL est autorisée à réparer le module et à remplacer les fusibles.**



## AVERTISSEMENT

Ne pas ouvrir la plaque avant du module au risque d'endommager le connecteur de l'indicateur / la façade de programmation PR 4501. Ce module ne contient ni de commutateurs DIP ni de cavaliers.

## SIGNIFICATION DES SYMBOLES



**Triangle avec point d'exclamation:** Attention! Lire ce manuel avant l'installation et la mise en service de ce module afin d'éviter des incidents pouvant causer des dommages corporels ou des dégâts mécaniques.



Le **signe CE** indique que le module est conforme aux exigences des directives.



Ce symbole indique que le module est protégé par une **isolation double** ou renforcée.



L'utilisation des modules de **type Ex** avec des installations situées dans des zones à risques d'explosions a été autorisée suivant la directive ATEX. Voir le schéma d'installation dans les annexes.

## CONSIGNES DE SECURITE

### DEFINITIONS

Les gammes de tensions dangereuses sont les suivantes : de 75 à 1500 Vcc et de 50 à 1000 Vca.

Les techniciens sont des personnes qualifiées qui sont capables de monter et de faire fonctionner un appareil, et d'y rechercher les pannes, tout en respectant les règles de sécurité.

Les opérateurs, connaissant le contenu de ce guide, règlent et actionnent les boutons ou les potentiomètres au cours des manipulations ordinaires.

## **RECEPTION ET DEBALLAGE**

Déballer le module sans l'endommager. Il est recommandé de conserver l'emballage du module tant que ce dernier n'est pas définitivement monté. A la réception du module, vérifiez que le type de module reçu correspond à celui que vous avez commandé.

## **ENVIRONNEMENT**

N'exposez pas votre module aux rayons directs du soleil et choisissez un endroit à l'humidité modérée et à l'abri de la poussière, des températures élevées, des chocs et des vibrations mécaniques et de la pluie. Le cas échéant, des systèmes de ventilation permettent d'éviter qu'une pièce soit chauffée au-delà des limites prescrites pour les températures ambiantes.

Ce module doit être installé en degré de pollution 2 ou meilleur.

Ce module est conçu pour fonctionner en toute sécurité sous une altitude inférieure à 2000 m.

## **MONTAGE**

Il est conseillé de réserver le raccordement du module aux techniciens qui connaissent les termes techniques, les avertissements et les instructions de ce guide et qui sont capables d'appliquer ces dernières.

Si vous avez un doute quelconque quant à la manipulation du module, veuillez contacter votre distributeur local. Vous pouvez également vous adresser à PR electronics SARL, Zac du Chêne, Activillage, 4, allée des Sorbiers, F-69673 Bron Cedex (tél. : (0) 472 140 607) ou à PR electronics A/S, Lerbakken 10, DK-8410 Rønne, Danemark (tél. : +45 86 37 26 77).

Pour le raccordement électrique de l'alimentation générale il est possible d'utiliser des fils multibrins seulement s'ils possèdent des embouts de câblage.

Les connexions des alimentations et des entrées / sorties sont décrites dans le schéma de principe et sur l'étiquette de la face latérale du module.

Les appareils sont équipés de borniers à vis et doivent être raccordés à une alimentation qui a une isolation double ou renforcée. L'interrupteur doit être à proximité du module et facile d'accès. Ce bouton doit être étiqueté avec la mention : peut couper la tension du module.

Pour une installation sur le rail d'alimentation 9400, le module sera alimenté par le contrôleur d'alimentation 9410.

L'année de production est définie par les deux premiers chiffres du numéro de série.

## **ETALONNAGE ET REGLAGE**

Lors des opérations d'étalonnage et de réglage, il convient d'effectuer les mesures et les connexions des tensions externes en respectant les spécifications mentionnées dans ce guide. Les techniciens doivent utiliser des outils et des instruments pouvant être manipulés en toute sécurité.

## **MANIPULATIONS ORDINAIRES**

Les opérateurs sont uniquement autorisés à régler et faire fonctionner des modules qui sont solidement fixés sur des platines des tableaux, ect., afin d'écartier les risques de dommages corporels. Autrement dit, il ne doit exister aucun danger d'électrocution et le module doit être facilement accessible.

## **MAINTENANCE ET ENTRETIEN**

Une fois le module hors tension, prenez un chiffon imbibé d'eau distillée pour le nettoyer.

## **LIMITATION DE RESPONSABILITE**

Dans la mesure où les instructions de ce guide ne sont pas strictement respectées par le client, ce dernier n'est pas en droit de faire une réclamation auprès de PR electronics SARL, même si cette dernière figure dans l'accord de vente conclu.

## **DEMONTAGE DU SYSTEME 9000**

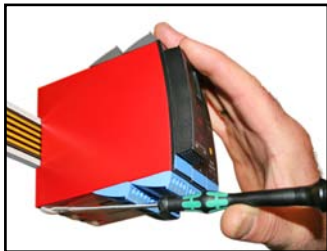

**Figure 1 :**  
Débloquez le verrou inférieur pour dégager le module du rail d'alimentation.

# DECLARATION DE CONFORMITE CE

En tant que fabricant

**PR electronics A/S**  
**Lerbakken 10**  
**DK-8410 Rønde**

déclare que le produit suivant :

**Type: 9113**  
**Nom: Convertisseur programable, [Ex ia]**

correspond aux directives et normes suivantes :

La directive CEM (EMC) 2004/108/CE et les modifications subséquentes

**EN 61326-1 : 2006**

Pour une spécification du niveau de rendement acceptable CEM (EMC)  
se référer aux spécifications électriques du module.

La directive basse tension 2006/95/CE et les modifications subséquentes

**EN 61010-1 : 2001**

La directive ATEX 94/9/CE et les modifications subséquentes

**EN 61241-0:2006, EN 61241-11:2006, EN 60079-0:2006,**  
**EN 60079-11:2007, EN 60079-15:2005, EN 60079-26:2007**  
**Certificat ATEX: KEMA 07ATEX0148 X**

Organisme notifié

**KEMA Quality B.V. (0344)**  
**Utrechtseweg 310, 6812 AR Arnhem**  
**P.O. Box 5185, 6802 ED Arnhem**  
**The Netherlands**

Rønde, le 24 septembre 2009

  
\_\_\_\_\_  
Kim Rasmussen  
Signature du fabricant

# CONVERTISSEUR PROGRAMMABLE, [Ex ia] 9113

- Entrées: Pt100, TC et mA
- Sortie mA active / passive
- 1 ou 2 voies
- Alimenté séparément ou par le rail, PR type 9400
- Certifié SIL 2 en «*Evaluation Complète*»

## Options avancées

- Programmation et contrôle à l'aide de la façade de programmation (4501); calibration de process et simulation de signaux.
- Recopie de la configuration d'un module à d'autres du même type à l'aide de la façade de programmation.
- Les entrées TC peuvent utiliser soit la CSF interne soit le bornier avec capteur Pt100 incorporé (PR 5910Ex, voie 1 / PR 5913Ex, voie 2) pour une précision améliorée.
- Le 9113 détecte automatiquement s'il doit fournir un signal de courant actif ou passif.
- Contrôle avancé de la communication interne et les données sauvegardées.
- La fonctionnalité SIL 2 est facultative et doit être activée dans un menu.

## Fonctions

- Le module peut être installé dans la zone non-dangereuse et en zone 2/div. 2 et recevoir des signaux de la zone 0, 1, 2, 20, 21 et 22/ Class I/II/III, Div. 1, Gr. A-G.
- Conversion et mise à l'échelle de signaux en température (Pt, Ni et TC) et en courant actif.
- Le 9113 a été conçue, développé et certifié pour utilisation dans les applications SIL 2 en conformité avec les exigences de la CEI 61508.

## Caractéristiques techniques

- 1 LED verte et 2 LED rouges en face avant indiquent un fonctionnement normal ou incorrect du module.
- Isolation galvanique de 2,6 kVca entre l'entrée, la sortie et l'alimentation.

# APPLICATIONS

## Signaux d'entrée :

Voie 1:

Courant TC

RTD  
Connexion,  
fils

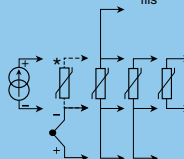

\*Commander séparément:  
Connecteur CSF 5910Ex/  
5913Ex

Voie 2:

Courant TC

RTD  
Connexion,  
fils

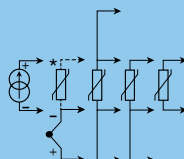

\*Commander séparément:  
Connecteur CSF 5910Ex/  
5913Ex

**Zone 0, 1, 2,  
20, 21, 22 /  
Cl. I/II/III, div. 1  
gr. A-G**

## Signaux de sortie :

Analogique, 0/4...20 mA

Voie 2:

Alimentation 2-fils -



Ch. 1:

Alimentation 2-fils -

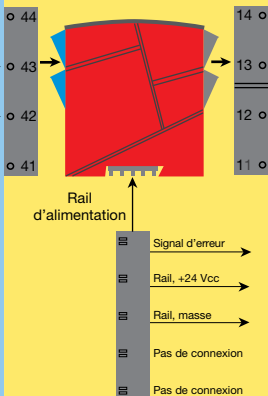
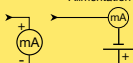

## Connexion d'alimentation :

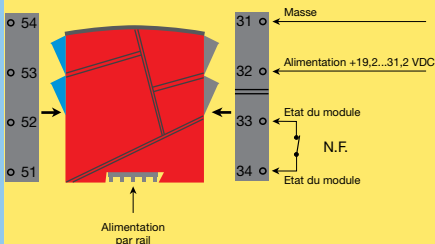

**Zone 2/Cl. 1, div. 2, gr. A-D ou zone non-dangereuse**

# PR 4501 INDICATEUR / FAÇADE DE PROGRAMMATION



## Functionalité

Le menu simple, structuré à l'aide de questions, guide automatiquement l'utilisateur par un menu déroulant et rend ainsi aisé l'utilisation du produit. Voir la description des fonctions et options de configuration dans la section « Configuration / utilisation des touches de fonction ».

## Application

- Interface de communication pour la modification des paramètres de fonctionnement du 9113.
- Peut être transféré d'un module à d'autres du même type et charger la configuration du premier module vers les modules suivants.
- Quand le 4501 est monté sur le module, il affiche les valeurs du process et l'état du module.

## Caractéristiques techniques

- Affichage LCD en quatre lignes; Ligne 1 (5,57 mm de haut) affiche l'état d'entrée, ligne 2 et 3 (3,33 mm de haut) affichent l'entrée analogique, la sortie analogique ou le numéro de repère ainsi que les unités, et ligne 4 affiche l'état de communication et l'état SIL (ouvert / verrouillé). Point statique = verrouillage SIL, point clignotante = aucun verrouillage SIL.
- L'accès à la programmation peut être bloqué par un mot de passe. Ce mot de passe est sauvegardé dans le module afin d'assurer un haut niveau de protection contre les modifications non autorisées.

## Montage / installation

- Cliquer le 4501 sur la face avant du 9113

## Références de commande

<b>9113BA</b>	=	<b>Convertisseur programmable, [Ex ia], 1 voie</b>
<b>9113BB</b>	=	<b>Convertisseur programmable, [Ex ia], 2 voies</b>
<b>4501</b>	=	<b>Indicateur / façade de programmation</b>
<b>5910Ex</b>	=	<b>Connecteur CSF, voie 1</b>
<b>5913Ex</b>	=	<b>Connecteur CSF, voie 2</b>
<b>9400</b>	=	<b>Rail d'alimentation</b>

## Spécifications

### Plages de température:

Plage d'utilisation ..... -20...+60°C

Température de stockage..... -20...+85°C

### Spécifications communes:

Tension d'alimentation, cc..... 19,2...31,2 Vcc

Consommation max. .... ≤ 3,5 W (2 voies)

Fusible ..... 400 mA SB / 250 Vca

### Tension d'isolation, test / opération:

Entrée / sortie / alimentation..... 2,6 kVca / 250 Vca

Sortie 1 à sortie 2..... 1,5 kVca / 150 Vca renforcée

Relais d'état à l'alimentation..... 1,5 kVca / 150 Vca renforcée

Interface de communication ..... Façade de programmation 4501

Rapport signal / bruit ..... Min. 60 dB (0...100 kHz)

### Temps de réponse moyen, délai inclu:

Entrée température ..... ≤ 1 s

Entrée mA..... ≤ 0,4 s

Température d'étalonnage ..... 20...28°C

Précision, la plus grande des valeurs générales et de base :

<b>Valeurs générales</b>		
Type d'entrée	Précision absolue	Coefficient de température
Tous	$\leq \pm 0,1\%$ de l'EC	$\leq \pm 0,01\%$ de l'EC / °C

<b>Valeur de base</b>		
Type d'entrée	Précision de base	Coefficient de température
mA	$\leq \pm 16 \mu\text{A}$	$\leq \pm 1,6 \mu\text{A} / ^\circ\text{C}$
Pt100, Pt200, Pt 1000	$\leq \pm 0,2^\circ\text{C}$	$\leq \pm 0,02^\circ\text{C} / ^\circ\text{C}$
Pt500, Ni100, Ni120, Ni 1000	$\leq \pm 0,3^\circ\text{C}$	$\leq \pm 0,03^\circ\text{C} / ^\circ\text{C}$
Pt50, Pt400, Ni50	$\leq \pm 0,4^\circ\text{C}$	$\leq \pm 0,04^\circ\text{C} / ^\circ\text{C}$
Pt250, Pt300	$\leq \pm 0,6^\circ\text{C}$	$\leq \pm 0,06^\circ\text{C} / ^\circ\text{C}$
Pt20	$\leq \pm 0,8^\circ\text{C}$	$\leq \pm 0,08^\circ\text{C} / ^\circ\text{C}$
Pt10	$\leq \pm 1,4^\circ\text{C}$	$\leq \pm 0,14^\circ\text{C} / ^\circ\text{C}$
Type TC: E, J, K, L, N, T, U	$\leq \pm 1^\circ\text{C}$	$\leq \pm 0,1^\circ\text{C} / ^\circ\text{C}$
Type TC: R, S, W3, W5, LR	$\leq \pm 2^\circ\text{C}$	$\leq \pm 0,2^\circ\text{C} / ^\circ\text{C}$
Type TC: B 160...400°C	$\leq \pm 4,5^\circ\text{C}$	$\leq \pm 0,45^\circ\text{C} / ^\circ\text{C}$
Type TC: B 400...1820°C	$\leq \pm 2^\circ\text{C}$	$\leq \pm 0,2^\circ\text{C} / ^\circ\text{C}$

Immunité CEM.....	$< \pm 0,5\%$ de l'EC
Immunité CEM améliorée:	
NAMUR NE 21, critère A, burst .....	$< \pm 1\%$ de l'EC

Taille des fils (min....max) ..... AWG 14...26 / 0,13...2,08 mm<sup>2</sup>  
fil multibrins

Pression max. avant déformation de la vis. 0,5 Nm

Humidité relative.....  $< 95\%$  RH (sans cond.)

Dimensions, sans façade 4501 (HxLxP) ..... 109 x 23,5 x 104 mm

Dimensions, avec façade 4501 (HxLxP) ..... 109 x 23,5 x 116 mm

Degré de protection ..... IP20  
 Poids ..... 250 g / 265 g avec 4501

**Isolation :**

Entrée aux autres ..... 300 Vca double/renforcée  
 Sortie analogique à l'alimentation..... 300 Vca double/renforcée  
 Relais d'état à l'alimentation ..... 150 Vca double/renforcée ou  
 300 Vca isolation de base

**Entrée RTD :**

Type d'entrée	Valeur min.	Valeur max.	Standard
Pt100 Ni100	-200°C -60°C	+850°C +250°C	IEC60751 DIN 43760

Entrée pour types RTD :

Pt10\*, Pt20\*, Pt50\*, Pt100, Pt200, Pt250, Pt300, Pt400, Pt500, Pt1000  
 Ni50, Ni100, Ni120, Ni1000

Résistance de ligne max. par fil..... 50 Ω  
 Courant de capteur ..... Nom. 0,2 mA  
 Effet de la résistance de ligne  
 3- / 4-fils..... < 0,002 Ω / Ω  
 Détection de rupture capteur ..... Programmable ON / OFF  
 Détection de court circuit..... < 2 µA  
 Courant de capteur :  
 pendant la détection ..... < 2 µA  
 si non..... 0 µA

\* Pas de détection de court circuit pour Pt10, Pt20 et Pt50

**Entrée TC :**

Type	Valeur min.	Valeur max.	Standard
B	+0°C	+1820°C	IEC 60584-1
E	-100°C	+1000°C	IEC 60584-1
J	-100°C	+1200°C	IEC 60584-1
K	-180°C	+1372°C	IEC 60584-1
L	-200°C	+900°C	DIN 43710
N	-180°C	+1300°C	IEC 60584-1
R	-50°C	+1760°C	IEC 60584-1
S	-50°C	+1760°C	IEC 60584-1
T	-200°C	+400°C	IEC 60584-1
U	-200°C	+600°C	DIN 43710
W3	0°C	+2300°C	ASTM E988-90
W5	0°C	+2300°C	ASTM E988-90
LR	-200°C	+800°C	GOST 3044-84

## Compensation de soudure froide (CSF):

avec capteur incorporé dans

le bornier 5910 .....  $20...28^{\circ}\text{C} \leq \pm 1^{\circ}\text{C}$   
 $-20...20^{\circ}\text{C}$  et  $28...70^{\circ}\text{C} \leq \pm 2^{\circ}\text{C}$

avec capteur CSF interne .....  $\pm(2,0^{\circ}\text{C} + 0,4^{\circ}\text{C} * \Delta t)$

$\Delta t$  = température interne - température ambiante

Détection erreur capteur ..... Programmable ON ou OFF  
(seulement rupture câble)

## Courant de capteur:

pendant la détection ..... Nom. 2  $\mu\text{A}$

si non..... 0  $\mu\text{A}$

## Entrée courant:

Gamme de mesure..... 0...20 mA

Gammes de mesure programmables..... 0...20 et 4...20 mA

Résistance d'entrée ..... Nom. 20  $\Omega$  + PTC 50  $\Omega$

Détection erreur capteur ..... Programmable ON / OFF  
Seulement 4...20 mA (NAMUR)

## Sortie courant:

Gamme de signal (EC) ..... 0...20 mA

Gammes de signal programmables ..... 0...20 / 4...20 / 20...0 et 20...4 mA

Charge (max.) ..... 20 mA / 600  $\Omega$  / 12 Vcc

Stabilité de charge .....  $\leq 0,01\%$  de l'EC / 100  $\Omega$

Détection erreur capteur ..... 0 / 3,5 / 23 mA / aucune

NAMUR NE 43 haut / bas d'échelle. .... 23 mA / 3,5 mA

## Limite de sortie :

signal 4...20 et 20...4 mA ..... 3,8...20,5 mA

signal 0...20 et 20...0 mA ..... 0...20,5 mA

Limite de courant .....  $\leq 28$  mA

## Sortie 2-fils 4...20 mA:

Gamme de signal ..... 4...20 mA

Stabilité de charge .....  $\leq 0,01\%$  de l'EC / 100  $\Omega$

Résistance de charge.....  $\leq (V_{\text{alimentation}} - 3,5) / 0,023$  A [ $\Omega$ ]

Gamme d'alimentation externe

pour transmetteur 2-fils..... 3,5...26 VDC

Effet d'une variation de la tension

d'alimentation externe 2-fils.....  $< 0,005\%$  de l'EC / V

## Relais d'état en zone non-dangereuse:

Tension max. .... 125 Vca / 110 Vcc

Courant max..... 0,5 Aca / 0,3 Acc

Puissance ca max. .... 62,5 VA / 32 W

## Approbation marine:

Det Norske Veritas, Ships & Offshore ..... En cours

**Approbation GOST R:**VNIIFTRI, Cert No..... Voir [www.preelectronics.fr](http://www.preelectronics.fr)**Certification SIL:**

exida, Cert No. .... PREI 070902 P0002 C03.01

**Agréments en homologations:****Standard:**

CEM (EMC) 2004/108/CE ..... EN 61326-1

DBT 2006/95/CE ..... EN 61010-1

ATEX 94/9/CE..... EN 60079-0, -11, -15, -26  
et EN 61241-0, -11IECEx..... IEC 60079-0, -11, -15 et -26  
IEC 61241-0 et -11

c FM us ..... FM 3600, 3611, 3810

CSA E60079-0, -15

CSA 22.2 -25, -142, -213

ANSI/ISA-12.00.01 / 12.12.02

UL, Standard for Safety ..... UL 61010-1

SIL ..... IEC 61508

**EC** = Echelle configurée

## Configuration du contrôle d'erreur de câble

Contrôle erreur capteur :		
Module :	Configuration	Détection erreur capteur
9113	OUT.ERR=NONE.	OFF
	Autre :	ON

## Indication dans le 4501 de : Signal d'entrée hors d'échelle

Indication de dépassement d'échelle (IN.LO, IN.HI) : En dépassement de l'échelle définie du convertisseur A/D ou des standards températures			
Entrée	Plage	Affichage	Limite
CURR	0...20 mA / 4...20 mA	IN.LO	< -1,05 mA
		IN.HI	> 25,05 mA
TEMP	TC / RTD	IN.LO	< plage température -2°C
		IN.HI	> plage température +2°C

Affichage en dessous du mini. / au-dessus du maxi (-1999, 9999) :			
Entrée	Plage	Affichage	Limit
Toutes	Tous	-1999	Indication <-1999
		9999	Indication >9999

## Détection erreur capteur

Détection erreur capteur (SE.BR, SE.SH) :			
Entrée	Plage	Affichage	Limite
CURR	Rupture de boucle (4...20 mA)	SE.BR	<= 3,6 mA ; > = 20,75 mA
TEMP	TC	SE.BR	> 10 kΩ...165 kΩ
		SE.BR	> 900...1000 Ω (câble > 50 Ω)
	RTD: 2-, 3- et 4-fils pour Pt10, Pt20, Pt50, Pt100, Pt200, Ni50 et Ni120	SE.SH	< env. 15 Ω
		RTD: 2-, 3- et 4-fils pour Pt250, Pt300, Pt400, Pt500, Pt1000 et Ni1000	SE.BR
SE.SH	< env. 15 Ω		

## Indications erreurs matériels

Indication erreur matériel		
Recherche erreurs	Affichage	Cause d'erreur
Entrée dépasse l'échelle basse	IN.LO	Voir conditions ci-dessus
Entrée dépasse l'échelle haute	IN.HI	Voir conditions ci-dessus
Rupture du câble capteur	SE.BR	Voir conditions ci-dessus
Court circuit du capteur	SE.SH	Voir conditions ci-dessus
Vérification du capteur CSF interne	CJ.ER	Défaut capteur CSF interne ou temp. CSF dépasse l'échelle**
Erreur connecteur CSF - contrôler le bornier CSF	CJ.CE	Bornier CSF en défaut ou manquant, température dépasse l'échelle valable

Indication erreur matériel		
Recherche erreurs	Affichage	Cause d'erreur
Erreur d'entrée - contrôler les connexions et redémarrer le module	IN.ER	Niveaux de signal en entrée dépasse limites ou connecté aux faux bornes*
Erreur de la sortie analogique - contrôler connexions et redémarrer le module	AO.ER	Erreur de courant de la sortie analog. (seul. en mode SIL)*
Pas de communication	NO.CO	Pas de communication avec (4501)
Erreur dans la mémoire FLASH - contrôler la configuration	FL.ER CO.ER	Erreur FLASH (configuration invalide)**
Configuration ou version invalide	TY.ER	Configuration lu de l'EEProm porte un numéro de type ou de révision invalide
Erreur matériel	RA.ER	Erreur RAM*
Erreur matériel	IF.ER	Erreur de Flash interne*
Erreur matériel	SW.ER	Erreur contrôleur SW*
Erreur matériel	AD.ER	Erreur du convertisseur A/D*
Erreur matériel	AO.SU	Erreur d'alim. de sortie analog.
Erreur matériel	CA.ER	Erreur d'étalonnage usine
Erreur matériel	CM.ER	Erreur du CPU principal*
Erreur matériel	II.ER	Erreur contrôle d'initialisation*
Erreur matériel	RS.ER	Erreur de redémarrage*
Erreur matériel	IC.ER	Erreur communication d'entrée*
Erreur matériel	M1.ER	Erreur CPU prin. à voie 1*
Erreur matériel	M2.ER	Erreur CPU prin. à voie 2*
Erreur matériel	MC.ER	Erreur config. du CPU prin.*
Erreur matériel	MF.ER	Erreur Flash du CPU prin.*
Erreur matériel	MR.ER	Erreur RAM du CPU prin.*
Erreur matériel	MS.ER	Erreur aliment. du CPU prin.*
Erreur matériel	MP.ER	Erreur ProgFlow du CPU prin.*

! Les indications d'erreurs clignotent toutes les secondes. Un texte d'aide explique l'erreur.

\* L'erreur est corrigée soit en parcourant les menus, soit en déconnectant et puis reconnectant l'alimentation du module.

Quelques types d'erreurs peuvent seulement être corrigées en déconnectant et puis reconnectant l'alimentation du module.

\*\* L'erreur est corrigée soit en parcourant les menus, soit en déconnectant et puis reconnectant l'alimentation du module.

L'erreur peut être négligée en sélectionnant un type d'entrée autre que TC.

\*\*\* L'erreur est corrigée en parcourant les menus.

# CONNEXIONS

Connexions au rail d'alimentation

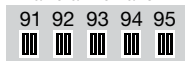

Signal d'erreur +24 V Masse NC NC

Signal d'erreur

+24 V

Masse

NC

NC

\* NC = pas de connexion

Alimentation et relais d'état

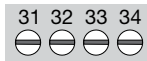

Masse

+24 V

N.F.

## Entrées

Voie 1

RTD, 2-fils



RTD, 3- / 4-fils



TC, capteur de température interne

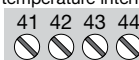

\*TC, connecteur CSF



Voie 2

RTD, 2-fils

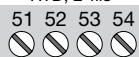

RTD, 3- / 4-fils

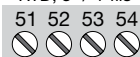

TC, capteur de température interne



\*TC, connecteur CSF

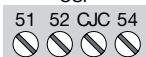

Voie 1

Courant



Voie 2

Courant

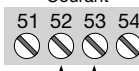

\* Commander séparément pour TC avec connecteur CSF :  
Connecteur CSF 5910Ex (voie 1) / 5913Ex (voie 2).

## Sorties

Voie 1

Courant (sortie active)

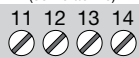

Transmetteur 2-fils (sortie passive)

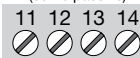

Voie 2

Courant (sortie active)

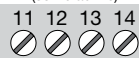

Transmetteur 2-fils (sortie passive)

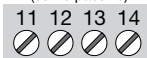

# SCHEMA DE PRINCIPE

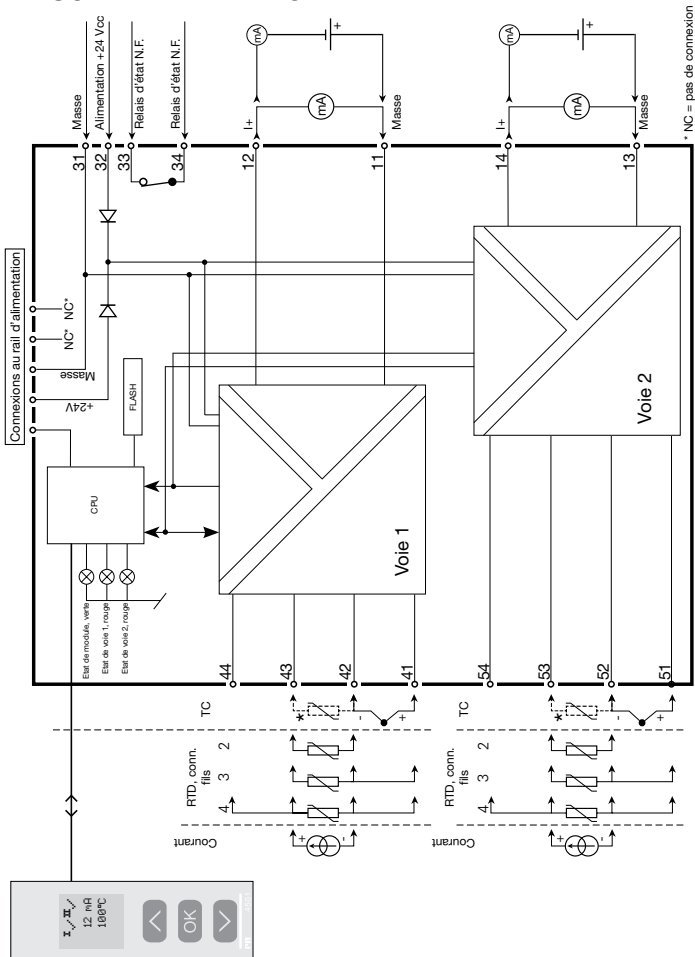

\* NC = pas de connexion

# 9113

## Indications d'erreur signal et câble sans la façade 4501

Liste d'indications des LED et signaux d'erreur					
Etat	LED verte	Voie 1: LED rouge	Voie 2: LED rouge	Relais d'état, N.F.	Etat de signal pour le rail
Module OK	Clignotante	OFF	OFF	Excité	Ouvert
Pas d'alimentation	OFF	OFF	OFF	Desexcité	Fermé
Défaut module	OFF	ON	ON	Desexcité	Fermé
Défaut voie 1 (voie 2 OK)	Clignotante	ON	OFF	Desexcité	Fermé
Défaut voie 2 (voie 1 OK)	Clignotante	OFF	ON	Desexcité	Fermé
Voie 1, signal OK	Clignotante	OFF	OFF	Excité	Ouvert
Voie 1, court circuit / rupture câble	Clignotante	Clignotante	OFF	Desexcité	Fermé (si activé)
Voie 2, signal OK	Clignotante	OFF	OFF	Excité	Ouvert
Voie 2, court circuit / rupture câble	Clignotante	OFF	Clignotante	Desexcité	Fermé (si activé)

# PROGRAMMATION / OPERATION DES TOUCHES DE FONCTION

Documentation pour le diagramme de programmation.

## Généralités

Lors de la configuration du 9113 vous êtes guidés tout au long des paramètres du menu; ainsi vous pouvez choisir le réglage qui correspond à votre application. Pour chaque menu il y a un texte d'aide qui défile en ligne 3 de l'indicateur.

La configuration se fait à l'aide des 3 touches de fonction :

- ⬆️ Incrémenter la valeur numérique ou choisir le paramètre suivant
- ⬇️ Décrémenter la valeur numérique ou choisir le paramètre précédent
- OK Valider les valeurs choisies et fin du menu

Une fois la configuration terminée, l'indicateur retournera sur l'état défaut 1.0.

En appuyant et maintenant la touche OK l'indicateur retourne au menu précédent ou sur l'état défaut (1.0) sans sauvegarde des modifications éventuelles apportées à la configuration.

Si aucune touche n'est activée pendant 1 minute, l'indicateur retournera sur l'état défaut sans sauvegarde des modifications éventuelles apportées à la configuration.

## Informations complémentaires

Protection par mot de passe: L'accès à la programmation peut être bloqué par un mot de passe. Ce mot de passe est sauvegardé dans le module afin d'assurer un haut niveau de protection contre les modifications non autorisées. Le mot de passe usine «2008» permet l'accès à tous les menus de configuration.

## Sélection des unités

En sélectionnant une entrée température, vous pouvez choisir l'unité de valeur du process pour l'affichage en texte ligne 2 (voir tableau). L'unité de mesure sur l'afficheur est en Celsius ou Fahrenheit. Ce choix se fait dans le point de menu après sélection d'entrée température.

## CSF (CJC)

Dans le menu CJC vous pouvez choisir entre connecteur CSF ou compensation de soudure froide interne. Le connecteur CSF (PR 5910Ex/5913Ex) est à commander séparément.

### Informations relatives à l'erreur de câble sur la façade 4501

Erreur de câble (voir limites dans tableau) est affichée par CA.BR (rupture câble) ou CA.SH (court circuit câble). Signal hors limite (voir tableau des limites) est affiché par IN.LO (limite basse) ou IN.HI (limite haute). L'affichage de l'erreur se fait en format texte sur la ligne 2 (voie 1) et la ligne 3 (voie 2) avec le rétro-éclairage lumineux clignotant. La ligne 4 de l'affichage indique l'état SIL (point statique = verrouillage SIL, point clignotante = aucun verrouillage SIL) et COM (point avec cercle courant) qui indique l'état de fonctionnement du 4501.

### Indication du signal et erreur capteur sans la façade

L'état du module peut être lu sur la façade à l'aide des 3 voyants.

Voyant vert clignotant indique l'état normal de fonctionnement.

Si le voyant vert n'est pas illuminé, cela indique un défaut d'alimentation ou une erreur dans le module.

Voyant rouge fixe indique un erreur fatale.

Voyant rouge clignotant indique une erreur capteur.

### Fonctions avancées

L'unité donne accès à un certain nombre de fonctions avancées qui sont accessibles en répondant « YES » à « ADV.SET ».

**Configuration de l'affichage:** Il est possible de régler la luminosité et le rétro-éclairage. Enregistrement d'un numéro de repère à 5 caractères alphanumériques. Sélection de l'affichage en ligne 2 et 3 de l'indicateur - choix entre: Entrée analogique, sortie analogique et numéro repère. En sélectionnant "ALT" l'affichage alterne les informations affichées.

**Calibration du process en 2 points:** L'unité peut procéder à une calibration en 2 points. Le point mini du signal d'entrée (pas nécessairement 0%) est appliquée et la valeur actuelle est entrée. Ensuite le point maxi du signal (pas nécessairement 100%) est appliquée et la valeur actuelle est entrée. Si vous validez ces points, l'appareil va fonctionner selon cet ajustement. Si plus tard vous souhaitez modifier ou changer de type d'entrée l'unité reviendra à la calibration usine.

**Fonction simulation :** Si vous validez le point «EN.SIM» il est possible de simuler un signal d'entrée à l'aide des flèches et ainsi contrôler le signal de sortie haut et bas. Vous devez sortir du menu en pressant ☒ (pas de time-out). La simulation sera terminée, si le 4501 est enlevé.

**Mot de passe :** Ici vous pouvez choisir un mot de passe allant de 0000 à 9999 afin de protéger la programmation. L'unité est livrée sans mot de passe.

**Langue :** Dans le menu «LANG», vous pouvez sélectionner 7 différentes langues pour le texte d'aide. Choix entre : Anglais, allemand, français, italien, espagnol, suédois et danois.

**Rail d'alimentation :** Dans le menu "RAIL" vous pouvez choisir si des erreurs capteur doivent être transmis à l'unité de surveillance du module PR 9410 Contrôleur d'alimentation.

**Safety Integrity Level:** Voir le "Safety Manual" (en Anglais) pour informations complémentaires.



# DIAGRAMME DE PROGRAMMATION

Si aucune touche n'est actionnée pendant 1 minute, l'indicateur retournera sur l'état défaut sans sauvegarde des modifications éventuelles apportées à la configuration.

- ⤴ Incrémenter la valeur / choisir paramètre suivant
- ⤵ Décrémenter la valeur / choisir paramètre précédent
- OK Valider les valeurs choisies et fin du menu

Maintien OK Retour au menu précédent / retour au menu 1.0 sans sauvegarde

Power up



1.0

Si le verrouillage SIL est activé directement en [EN.SIL]

0000  
9999

NO  
YES

CURR  
TEMP

4-20  
0-20

20-4  
20-0  
4-20  
0-20

23mA  
0/3.5mA  
NONE

0000  
PASSW  
Txt 1

NO  
ADU.SET  
Txt 2

CURR  
CHI TYPE  
Txt 3

4-20  
I RANGE  
Txt 4

4-20  
O RANGE  
Txt 12

23  
OUT.ERR  
Txt 13

1.1

1.2

- 1.0 = Etat défaut. Ligne 1 affiche l'état d'entrée, ligne 2 et 3 affichent l'entrée analogique, la sortie analogique ou le numéro de repère ainsi que les unités, et ligne 4 affiche l'état de communication et l'état SIL (ouvert/verrouillé). Point statique = verrouillage SIL, point clignotant = aucun verrouillage SIL.
- 1.1 = Seulement si l'indicateur est protégé par un mot de passe
- 1.2 = Ne vaut pas pour le signal d'entrée : 0...20 mA.
- 1.3 = Seulement si le signal d'entrée est température. Min. et max. selon le type de capteur.
- 1.4 = Seulement si la configuration n'est pas protégé par un mot de passe

- 1.1 = Seulement si l'indicateur est protégé par un mot de passe
- 1.2 = Ne vaut pas pour le signal d'entrée : 0...20 mA.
- 1.3 = Seulement si le signal d'entrée est température. Min. et max. selon le type de capteur.
- 1.4 = Seulement si la configuration n'est pas protégé par un mot de passe

- 1.3 = Seulement si le signal d'entrée est température. Min. et max. selon le type de capteur.
- 1.4 = Seulement si la configuration n'est pas protégé par un mot de passe

Texte rouge signifie des paramètres de sécurité dans une configuration SIL. Voir le "Safety Manual" (en Anglais) pour informations complémentaires.

YES  
ADU.SET  
Txt 2

Continué à la page Diagramme de programmation ADV.SET

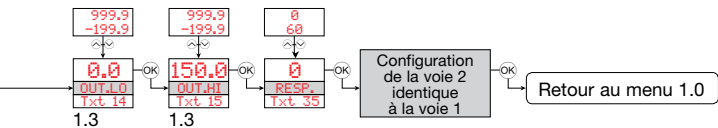

# DIAGRAMME DE PROGRAMMATION, REGLAGE AVANCE (ADV.SET)

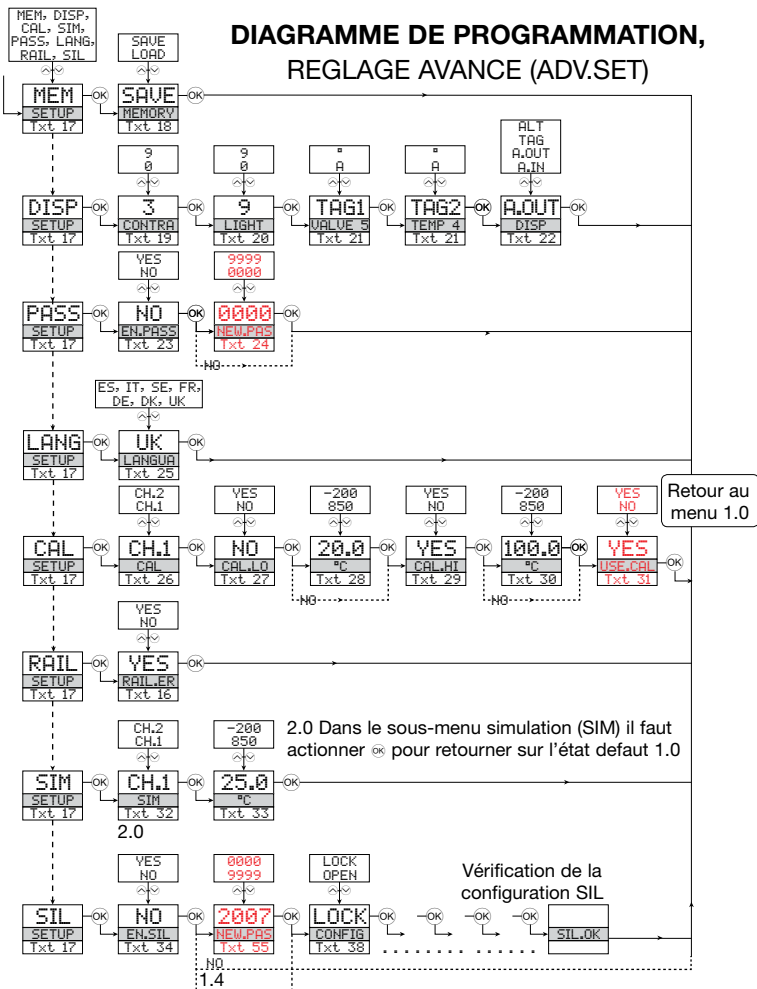

# MENU DEROULANT EN LIGNE 3 DE L'INDICATEUR

- [01] Entrer mot de passe correct
- [02] Aller dans le menu de configuration avancée ?
- [03] Sélectionner entrée température  
Sélectionner entrée courant
- [04] Sélectionner gamme d'entrée 0-20 mA  
Sélectionner gamme d'entrée 4-20 mA
- [05] Sélectionner type de capteur TC  
Sélectionner type de capteur Ni  
Sélectionner type de capteur Pt
- [06] Sélectionner Pt100 comme type de capteur  
Sélectionner Pt200 comme type de capteur  
Sélectionner Pt500 comme type de capteur  
Sélectionner Pt1000 comme type de capteur  
Sélectionner Pt2000 comme type de capteur  
Sélectionner Pt2500 comme type de capteur  
Sélectionner Pt3000 comme type de capteur  
Sélectionner Pt4000 comme type de capteur  
Sélectionner Pt5000 comme type de capteur  
Sélectionner Pt10000 comme type de capteur
- [07] Sélectionner Ni500 comme type de capteur  
Sélectionner Ni1000 comme type de capteur  
Sélectionner Ni1200 comme type de capteur  
Sélectionner Ni10000 comme type de capteur
- [08] Sélectionner TC-B comme type de capteur  
Sélectionner TC-E comme type de capteur  
Sélectionner TC-J comme type de capteur  
Sélectionner TC-K comme type de capteur  
Sélectionner TC-L comme type de capteur  
Sélectionner TC-N comme type de capteur  
Sélectionner TC-R comme type de capteur  
Sélectionner TC-S comme type de capteur  
Sélectionner TC-T comme type de capteur  
Sélectionner TC-U comme type de capteur  
Sélectionner TC-W3 comme type de capteur  
Sélectionner TC-W5 comme type de capteur  
Sélectionner TC-Lr comme type de capteur
- [09] Sélectionner connexion capteur 2-fils  
Sélectionner connexion capteur 3-fils  
Sélectionner connexion capteur 4-fils
- [11] Sélectionner Celsius comme unité de température  
Sélectionner Fahrenheit comme unité de température
- [12] Sélectionner gamme de sortie 0-20 mA  
Sélectionner gamme de sortie 4-20 mA  
Sélectionner gamme de sortie 20-0 mA  
Sélectionner gamme de sortie 20-4 mA
- [13] Sélectionner aucune action d'erreur - sortie pas définie en cas d'erreur  
Sélectionner bas d'échelle en cas d'erreur  
Sélectionner NAMUR NE43 bas d'échelle en cas d'erreur  
Sélectionner NAMUR NE43 haut d'échelle en cas d'erreur
- [14] Régler température de la sortie analogique basse
- [15] Régler température de la sortie analogique haute
- [16] Activer signal d'état du rail d'alimentation
- [17] Aller dans la configuration SIL  
Aller dans le mode simulation  
Aller dans la configuration du rail d'alimentation  
Exécuter calibration de process  
Aller dans la configuration langue  
Aller dans la configuration du mot de passe  
Aller dans la configuration d'affichage  
Exécuter opérations de mémoire
- [18] Charger la configuration sauvegardée au module  
Sauvegarder la configuration dans la 4501
- [19] Ajuster le contraste LCD
- [20] Ajuster le rétro-éclairage LCD
- [21] Entrer numéro repère de 5 caractères
- [22] Valeur de l'entrée analogique affichée en ligne 3  
Valeur de la sortie analogique affichée en ligne 3  
Numéro repère affiché en ligne 3  
Alterner les informations affichées
- [23] Permettre protection par mot de passe ?
- [24] Entrer Nouveau mot de passe
- [25] Sélectionner langue
- [26] Sélectionner voie pour calibration
- [27] Calibrer l'entrée basse à la valeur de process ?
- [28] Régler valeur de la position basse de la calibration
- [29] Calibrer l'entrée haute à la valeur de process ?
- [30] Régler valeur de la position haute de la calibration
- [31] Utiliser valeurs de calibration process ?
- [32] Sélectionner voie pour simulation
- [33] Régler la valeur de simulation en entrée
- [34] Permettre verrouillage de la configuration SIL ?  
0-20 mA n'est pas une gamme de sortie valable en opération SIL
- [35] Régler temps de réponse de la sortie analogique en secondes
- [36] Sélectionner Capteur de température interne  
Sélectionner Bornier CSF (accessoire)
- [37] ... Ect-ce que la voie utilise des données de calibration compensées au process ?
- [38] Etat de la configuration SIL ( Ouverte / Verrouillée)
- [40] Rupture du câble capteur
- [41] Court circuit du capteur
- [42] Entrée dépasse l'échelle basse
- [43] Entrée dépasse l'échelle haute
- [44] Erreur d'entrée - contrôler les connexions et redémarrer le module
- [45] Erreur de la sortie analog. - contrôler connexions et redémarrer le module
- [46] Erreur dans la mémoire FLASH - contrôler la configuration
- [47] Configuration ou version invalide
- [48] Erreur matériel
- [49] Erreur du capteur CSF - contrôler la température du module
- [50] Erreur CSF - contrôler le bornier CSF
- [51] Pas de communication



# TEMPERATUR / mA WANDLER

## 9113

### INHALTSVERZEICHNIS

Warnung .....	78
Zeichenerklärungen .....	78
Sicherheitsregeln .....	78
Zerlegung des Systems 9000 .....	80
EG-Konformitätserklärung .....	81
Erweiterte Merkmale .....	82
Verwendung .....	82
Technische Merkmale .....	82
Anwendungen .....	83
PR 4501 Display / Programmierfront .....	84
Bestellangaben .....	85
Elektrische Daten .....	85
Konfiguration der Sensorfehlerüberprüfung .....	90
Visualisierung im 4501:	
Eingangssignal außerhalb des Bereichs .....	90
Fühlerfehlererkennung .....	90
Fehleranzeige .....	90
Anschlüsse .....	92
Blockdiagramm .....	93
Signalfehler- und Kabelfehler Erkennung ohne Frontdisplay .....	94
Konfiguration / Bedienung der Funktionstasten .....	95
Flussdiagramm, Erweiterte Einstellungen (ADV.SET) .....	100
Scrollender Hilfstext im Display Zeile 3 .....	101
Appendix .....	102
IECEx Installation Drawing .....	103
ATEX Installation Drawings, UK, FR, DE, DK .....	106
FM Installation Drawing .....	118
Safety Manual .....	121



## WARNUNG

Die folgende Maßnahmen sollten nur in spannungslosem Zustand des Gerätes und unter ESD-sicheren Verhältnisse durchgeführt werden:

Installation, Montage und Demontage von Leitungen.  
Fehlersuche im Gerät.

**Reparaturen des Gerätes und Austausch von Sicherungen dürfen nur von PR electronics A/S vorgenommen werden.**



## WARNUNG

Die Frontplatte des Gerätes darf nicht geöffnet werden, weil hierdurch die Kontakte zur Kontaktierung des Frontdisplays 4501 beschädigt werden können. Das Gerät enthält keine internen DIP-Schalter oder Programmierbrücken.

## ZEICHENERKLÄRUNGEN



**Dreieck mit Ausrufungszeichen:** Das Handbuch ist sorgfältig durchzulesen vor Montage und Inbetriebnahme des Gerätes, um schweren Verletzungen oder mechanischer Zerstörung zu vermeiden.



**Die CE-Marke** ist das sichtbare Zeichen dafür, dass das Gerät die Vorschriften erfüllt.



**Doppelte Isolierung** ist das Symbol dafür, dass das Gerät besondere Anforderungen an die Isolierung erfüllt.



**Ex-Geräte** sind entsprechend der ATEX Direktive für die Verwendung in Verbindung mit Installationen in explosionsgefährdeter Umgebung zugelassen.

## SICHERHEITSREGELN

### DEFINITIONEN

**Gefährliche Spannungen** sind definitionsgemäß die Bereiche: 75...1500 Volt Gleichspannung und 50...1000 Volt Wechselspannung.

**Techniker** sind qualifizierte Personen, die dazu ausgebildet oder angelernt sind, eine Installation, Bedienung oder evtl. Fehlersuche auszuführen, die sowohl technisch als auch sicherheitsmäßig vertretbar ist.

**Bedienungspersonal** sind Personen, die im Normalbetrieb mit dem Produkt die Drucktasten oder Potentiometer des Produktes einstellen bzw. bedienen und die mit dem Inhalt dieses Handbuches vertraut gemacht wurden.

## **EMPFANG UND AUSPACKEN**

Packen Sie das Gerät aus, ohne es zu beschädigen und kontrollieren Sie beim Empfang, ob der Gerätetyp Ihrer Bestellung entspricht. Die Verpackung sollte beim Gerät bleiben, bis dieses am endgültigen Platz montiert ist.

## **UMGEBUNGSBEDINGUNGEN**

Direkte Sonneneinstrahlung, starke Staubentwicklung oder Hitze, mechanische Erschütterungen und Stöße sind zu vermeiden; das Gerät darf nicht Regen oder starker Feuchtigkeit ausgesetzt werden. Bei Bedarf muss eine Erwärmung, welche die angegebenen Grenzen für die Umgebungstemperatur überschreitet, mit Hilfe eines Kühlgebläses verhindert werden.

Das Gerät muss im Verschmutzungsgrad 2 oder besser installiert werden.

Das Gerät ist so konzipiert, dass es auch in einer Einsatzhöhe von bis zu 2 000 m noch sicher funktioniert.

## **INSTALLATION**

Das Gerät darf nur von Technikern angeschlossen werden, die mit den technischen Ausdrücken, Warnungen und Anweisungen im Handbuch vertraut sind und diese befolgen.

Sollten Zweifel bezüglich der richtigen Handhabung des Gerätes bestehen, sollte man mit dem Händler vor Ort Kontakt aufnehmen. Sie können aber auch direkt mit **PR electronics GmbH, Im Erlengrund 26, D-46149 Oberhausen, (Tel.: (0) 208 62 53 09-0)** oder mit **PR electronics A/S, Lerbakken 10, DK-8410 Rønne, Dänemark (Tel.: +45 86 37 26 77)** Kontakt aufnehmen.

Der Einsatz von verdillter Leitung ist nicht erlaubt außer die Enden sind mit Aderendhülsen versehen.

Eine Beschreibung von Eingangs- / Ausgangs- und Versorgungsanschlüssen befindet sich auf dem Blockschaltbild und auf dem seitlichen Schild.

Das Gerät ist mit Feldverdrahtungsklemmen ausgestattet und wird von einem Netzteil mit doppelter / verstärkter Isolierung versorgt. Der Netzschalter sollte leicht zugänglich und in der Nähe des Gerätes sein. Der Netzschalter sollte mit einem Schild gekennzeichnet sein, auf dem steht, dass durch Betätigung dieses Schalters das Gerät vom Netz genommen wird.

Für den Anschluss auf der Power Rail 9400 wird das Gerät über das Power Control Unit 9410 versorgt.

Die ersten beiden Ziffern der Seriennummer geben das Produktionsjahr an.

## **KALIBRIERUNG UND JUSTIERUNG**

Während der Kalibrierung und Justierung sind die Messung und der Anschluss externer Spannungen entsprechend diesem Handbuch auszuführen, und der Techniker muss hierbei sicherheitsmäßig einwandfreie Werkzeuge und Instrumente benutzen.

## **BEDIENUNG IM NORMALBETRIEB**

Das Bedienungspersonal darf das Gerät nur dann einstellen oder bedienen, wenn diese auf vertretbare Weise in Schalttafeln o. ä. fest installiert sind, sodass die Bedienung keine Gefahr für Leben oder Material mit sich bringt. D. h., es darf keine Gefahr durch Berührung bestehen, und das Gerät muss so plaziert sein, dass es leicht zu bedienen ist.

## **REINIGUNG**

Das Gerät darf in spannungslosem Zustand mit einem Lappen gereinigt werden, der mit destilliertem Wasser leicht angefeuchtet ist.

## **HAFTUNG**

In dem Umfang, in welchem die Anweisungen dieses Handbuches nicht genau eingehalten werden, kann der Kunde PR electronics gegenüber keine Ansprüche geltend machen, welche ansonsten entsprechend der eingegangenen Verkaufsvereinbarungen existieren können.

## **ZERLEGUNG DES SYSTEMS 9000**

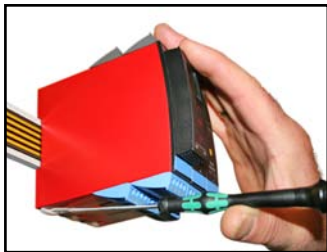

**Abbildung 1:**

Das Gerät wird von der Power Rail gelöst, indem man den unteren Verschluss löst.

# EG-KONFORMITÄTSERKLÄRUNG

Als Hersteller bescheinigt

**PR electronics A/S**  
**Lerbakken 10**  
**DK-8410 Rønde**

hiermit für das folgende Produkt:

**Typ: 9113**  
**Name: Temperatur / mA Wandler**

die Konformität mit folgenden Richtlinien und Normen:

Die EMV Richtlinien 2004/108/EG und nachfolgende Änderungen

**EN 61326-1 : 2006**

Zur Spezifikation des zulässigen Erfüllungsgrades, siehe die Elektrische Daten des Gerätes.

Die Niederspannungsrichtlinien 2006/95/EG und nachfolgende Änderungen

**EN 61010-1 : 2001**

Die ATEX Richtlinien 94/9/EG und nachfolgende Änderungen

**EN 61241-0:2006, EN 61241-11:2006, EN 60079-0:2006,**  
**EN 60079-11:2007, EN 60079-15:2005, EN 60079-26:2007**  
**ATEX-Zertifikat: KEMA 07ATEX0148 X**

Zulassungsstelle:

**KEMA Quality B.V. (0344)**  
**Utrechtseweg 310, 6812 AR Arnhem**  
**P.O. Box 5185, 6802 ED Arnhem**  
**The Netherlands**

Rønde, 24. September 2009



Kim Rasmussen  
Unterschrift des Herstellers

# TEMPERATUR / mA WANDLER

## 9113

- *Eingang für WTH, TE und mA*
- *Aktiver / passiver mA-Ausgang*
- *1 oder 2 Kanäle*
- *Kann separat über Klemmenanschluss oder über die Power Rail 9400 versorgt werden*
- *SIL 2-zertifiziert über Full Assessment*

### Erweiterte Merkmale

- Konfiguration und Überwachung über das abnehmbare Frontdisplay (PR 4501); Prozesskalibrierung und Signalsimulation.
- Kopieren der Konfiguration zwischen Geräten des gleichen Typs über das abnehmbare Frontdisplay 4501.
- Temperaturkompensation entweder über die interne CJC oder zur höheren Genauigkeit die externe CJC mittels einer Anschlussklemme mit integrierten Pt100 (5910Ex, Kanal 1 / 5913Ex, Kanal 2) benutzen.
- Das Gerät erkennt automatisch, ob es ein aktives oder ein passives Stromsignal liefern muss.
- Erweiterte Überwachung der internen Kommunikation und gespeicherten Daten.
- SIL 2-Funktionalität ist optional und muss über einen Menüpunkt aktiviert werden.

### Verwendung

- Das Gerät kann in sicheren Bereichen und in Zone 2 / div. 2 eingesetzt werden und Signale aus Zone 0, 1, 2, 20, 21 sowie 22 / Class I/II/III, Div. 1, Gr. A-G aufnehmen.
- Umwandlung und Skalierung von Temperatursignalen (Pt, Ni und TE) sowie aktiven Stromsignalen.
- Der 9113 wurde entwickelt und zertifiziert für SIL 2-Anwendungen entsprechend den Anforderungen der Richtlinie IEC 61508.

### Technische Merkmale

- 1 grüne und 2 rote Leuchtdioden in der Front des Gerätes zeigen den normalen Betrieb und Fehlfunktionen an.
- 2,6 kVAC galvanische Trennung zwischen Eingang, Ausgang und Versorgung.

# ANWENDUNGEN

## Eingangssignale:

Kanal 1:

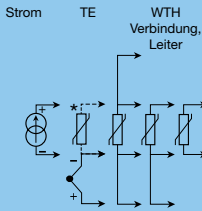

Bitte die CJC-Anschlussklemme Typ 5910Ex/ 5913Ex separat bestellen!

Kanal 2:

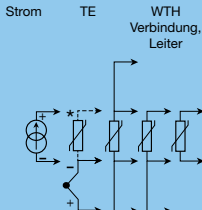

Bitte die CJC-Anschlussklemme Typ 5910Ex/ 5913Ex separat bestellen!

**Zone 0, 1, 2,  
20, 21, 22 /  
Cl. I/II/III, div. 1  
gr. A-G**

## Ausgangssignale:

Analog, 0/4...20 mA

Kanal 2:

2-Draht-Versorgung -



Kanal 1:

2-Draht-Versorgung -



Power Rail

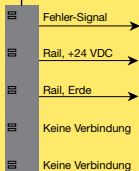

## Versorgungsanschluss:

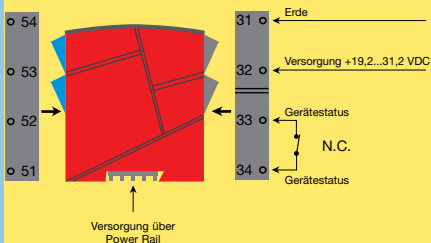

**Zone 2 / Cl. 1, div. 2, gr. A-D oder sicheres Bereich**

# PR 4501 DISPLAY / PROGRAMMIERFRONT



## Funktionalität

Die einfache Menüstruktur leitet automatisch durch die relevanten Einstellungen. Der scrollende Hilfetext macht es sehr einfach diese Geräte einzusetzen. Sie finden weitere Beschreibungen der Funktionen und Programmierungsmöglichkeiten im Abschnitt "Konfiguration / Bedienung der Funktionstasten".

## Anwendungen

- Kommunikationsschnittstelle zur Änderung der operativen Parameter im 9113.
- Kann von einem 9113 auf das nächste gesteckt werden um die Daten des ersten Messumformers auf den nächsten zu übertragen.
- Wenn das Gerät im Prozess integriert ist, zeigt das Display die entsprechenden Prozesswerte und den jeweiligen Prozessstatus an.

## Technische Merkmale

- LCD Display mit 4 Zeilen; Zeile 1 (5,57 mm hoch) zeigt das Eingangsstatus, Zeile 2 und 3 (3,33 mm hoch) zeigen den Analogeingang, Analogausgang oder den Geräte-TAG und die Einheiten, und Zeile 4 den Status der SIL-Konfiguration (offen / verriegelt) an. Statischer Punkt = SIL-verriegelt, blinkender Punkt = nicht SIL-verriegelt. Zeile 4 zeigt auch den Kommunikationsstatus an.
- Der Zugriff auf die Programmierung kann mit der Eingabe eines Passwortes blockiert werden. Das Passwort wird im Messumformer gespeichert, um den höchsten Grad an Schutz gegen nicht autorisierte Änderungen der Konfiguration sicherzustellen.

## Montage / Installation

- Stecke das 4501 auf die Front des 9113.

## Bestellangaben

<b>9113BA</b>	=	<b>Temperatur / mA Wandler, 1 Kanal</b>
<b>9113BB</b>	=	<b>Temperatur / mA Wandler, 2 Kanäle</b>
<b>4501</b>	=	<b>Display / Programmierfront</b>
<b>5910Ex</b>	=	<b>CJC-Anschlussstecker, Kanal 1</b>
<b>5913Ex</b>	=	<b>CJC-Anschlussstecker, Kanal 2</b>
<b>9400</b>	=	<b>Power Rail</b>

## Elektrische Daten

Umgebungstemperatur .....	-20...+60°C
Lagertemperatur .....	-20...+85°C

### Allgemeine Daten:

Versorgungsspannung, DC .....	19,2...31,2 VDC
Stromverbrauch, max.....	≤ 3,5 W (2 Kanäle)
Sicherung .....	400 mA T / 250 VAC
Isolationsspannungen, Test / Betrieb:	
Eingang / Ausgang / Versorgung .....	2,6 kVAC / 250 VAC
Ausgang 1 zum Ausgang 2 .....	1,5 kVAC / 150 VAC verstärkt
Statusrelais zur Versorgung .....	1,5 kVAC / 150 VAC verstärkt
Kommunikationsschnittstelle .....	Programmierfront 4501
Signal- / Rauschverhältnis .....	Min. 60 dB (0...100 kHz)
Durchschnittliches Ansprechzeit inkl. Verzögerung:	
Temperatur-Eingang .....	≤ 1 s
mA-Eingang.....	≤ 0,4 s
Kalibrierungstemperatur.....	20...28°C

Genauigkeit: Der höhere Wert der allgemeinen Werte oder Grundwerte:

<b>Allgemeine Werte</b>		
Eingangsart	Absolute Genauigkeit	Temperaturkoeffizient
Alle	$\leq \pm 0,1\%$ d. Messsp.	$\leq \pm 0,01\%$ d. Messsp. / °C

<b>Grundwerte</b>		
Eingangsart	Grundgenauigkeit	Temperaturkoeffizient
mA	$\leq \pm 16 \mu\text{A}$	$\leq \pm 1,6 \mu\text{A} / ^\circ\text{C}$
Pt100, Pt200, Pt 1000	$\leq \pm 0,2^\circ\text{C}$	$\leq \pm 0,02^\circ\text{C} / ^\circ\text{C}$
Pt500, Ni100, Ni120, Ni 1000	$\leq \pm 0,3^\circ\text{C}$	$\leq \pm 0,03^\circ\text{C} / ^\circ\text{C}$
Pt50, Pt400, Ni50	$\leq \pm 0,4^\circ\text{C}$	$\leq \pm 0,04^\circ\text{C} / ^\circ\text{C}$
Pt250, Pt300	$\leq \pm 0,6^\circ\text{C}$	$\leq \pm 0,06^\circ\text{C} / ^\circ\text{C}$
Pt20	$\leq \pm 0,8^\circ\text{C}$	$\leq \pm 0,08^\circ\text{C} / ^\circ\text{C}$
Pt10	$\leq \pm 1,4^\circ\text{C}$	$\leq \pm 0,14^\circ\text{C} / ^\circ\text{C}$
TE-Typ: E, J, K, L, N, T, U	$\leq \pm 1^\circ\text{C}$	$\leq \pm 0,1^\circ\text{C} / ^\circ\text{C}$
TE-Typ: R, S, W3, W5, LR	$\leq \pm 2^\circ\text{C}$	$\leq \pm 0,2^\circ\text{C} / ^\circ\text{C}$
TE-Typ: B 160...400°C	$\leq \pm 4,5^\circ\text{C}$	$\leq \pm 0,45^\circ\text{C} / ^\circ\text{C}$
TE-Typ: B 400...1820°C	$\leq \pm 2^\circ\text{C}$	$\leq \pm 0,2^\circ\text{C} / ^\circ\text{C}$

EMV Störspannungseinfluss .....	$< \pm 0,5\%$ d. Messsp.
Erweitere EMV Störfestigkeit:	
NAMUR NE 21, Kriterium A, Burst.....	$< \pm 1\%$ d. Messsp.

Leitungsquerschnitt..... AWG 26...14 / 0,13...2,08 mm<sup>2</sup>  
Litzendraht  
Klemmschraubenanzugsmoment..... 0,5 Nm  
Relative Luftfeuchtigkeit.....  $< 95\%$  RF (nicht kond.)  
Abmessungen, ohne Frontdisplay (HxBxD).. 109 x 23,5 x 104 mm  
Abmessungen, mit Frontdisplay (HxBxD) ... 109 x 23,5 x 116 mm

Schutzart ..... IP20  
Gewicht ..... 250 g / 265 g mit 4501

**Isolierung:**

Eingang zu irgenwelchen ..... 300 VAC doppelte/verstärkte Iso.  
Analogausgang zur Versorgung ..... 300 VAC doppelte/verstärkte Iso.  
Statusrelais zur Versorgung ..... 150 VAC doppelte/verstärkte oder  
300 VAC Basisisolierung

**WTH-Eingang:**

Eingangs- art	Min. Wert	Max. Wert	Norm
Pt100 Ni100	-200°C -60°C	+850°C +250°C	IEC60751 DIN 43760

Eingang für TE-Typen:

Pt10\*, Pt20\*, Pt50\*, Pt100, Pt200, Pt250, Pt300, Pt400, Pt500, Pt1000  
Ni50, Ni100, Ni120, Ni1000

Kabelwiderstand pro Leiter (max.) ..... 50 Ω

Fühlerstrom ..... Nom. 0,2 mA

Wirkung des Leitungswiderstandes

(3- / 4-Leiter) ..... < 0,002 Ω / Ω

Fühlerfehlererkennung..... Programmierbar ON / OFF

Fühlerfehlerstrom:

Bei Erkennung..... < 2 μA

Sonst ..... 0 μA

\* Keine Kurzschlusserkennung für Pt10, Pt20 und Pt50

**TE-Eingang:**

Typ	Min. Wert	Max. Wert	Norm
B	+0°C	+1820°C	IEC 60584-1
E	-100°C	+1000°C	IEC 60584-1
J	-100°C	+1200°C	IEC 60584-1
K	-180°C	+1372°C	IEC 60584-1
L	-200°C	+900°C	DIN 43710
N	-180°C	+1300°C	IEC 60584-1
R	-50°C	+1760°C	IEC 60584-1
S	-50°C	+1760°C	IEC 60584-1
T	-200°C	+400°C	IEC 60584-1
U	-200°C	+600°C	DIN 43710
W3	0°C	+2300°C	ASTM E988-90
W5	0°C	+2300°C	ASTM E988-90
LR	-200°C	+800°C	GOST 3044-84

## Vergleichsstellenkompensation (CJC):

über externen Sensor in der

Anschlussklemme 5910 .....  $20...28^{\circ}\text{C} \leq \pm 1^{\circ}\text{C}$   
 $-20...20^{\circ}\text{C}$  og  $28...70^{\circ}\text{C} \leq \pm 2^{\circ}\text{C}$

über internen CJC-Sensor .....  $\pm(2,0^{\circ}\text{C} + 0,4^{\circ}\text{C} * \Delta t)$

$\Delta t$  = interne Temperatur - Umgebungstemperatur

Fühlerfehlererkennung..... Programmierbar ON oder OFF  
(nur Kabel Drahtbruch)

Fühlerfehlerstrom:

bei Erkennung ..... Nom.  $2 \mu\text{A}$

sonst.....  $0 \mu\text{A}$

## Stromeingang:

Messbereich .....  $0...20 \text{ mA}$

Programmierbare Messbereiche .....  $0...20$  und  $4...20 \text{ mA}$

Eingangswiderstand ..... Nom.  $20 \Omega + \text{PTC } 50 \Omega$

Fühlerfehlererkennung..... Programmierbar ON / OFF  
Nur  $4...20 \text{ mA}$  (NAMUR)

## Stromausgang:

Signalbereich (Spanne) .....  $0...20 \text{ mA}$

Programmierbare Signalbereiche.....  $0...20 / 4...20 /$   
 $20...0$  und  $20...4 \text{ mA}$

Belastung (max.).....  $20 \text{ mA} / 600 \Omega / 12 \text{ VDC}$

Belastungsstabilität .....  $\leq 0,01\%$  d. Messspanne /  $100 \Omega$

Fühlerfehlererkennung.....  $0 / 3,5 / 23 \text{ mA} / \text{keine}$

NAMUR NE 43 Upscale/Downscale .....  $23 \text{ mA} / 3,5 \text{ mA}$

Ausgangsbegrenzung:

$4...20$  und  $20...4 \text{ mA}$  Signale.....  $3.8...20,5 \text{ mA}$

$0...20$  und  $20...0 \text{ mA}$  Signale.....  $0...20,5 \text{ mA}$

Strombegrenzung.....  $\leq 28 \text{ mA}$

## 2-Draht-Ausgang 4...20 mA:

Signalbereich.....  $4...20 \text{ mA}$

Belastungsstabilität .....  $\leq 0,01\%$  d. Messspanne /  $100 \Omega$

Belastungswiderstand.....  $\leq (V_{\text{Versorgung}} - 3,5) / 0,023 \text{ A} [\Omega]$

Externe 2-Draht-Versorgungsbereich.....  $3,5...26 \text{ VDC}$

Wirkung der externen 2-Draht

Versorgungsspannungsänderung.....  $< 0,005\%$  d. Messspanne / V

## Statusrelais in sicheres Bereich:

Max. Spannung .....  $125 \text{ VAC} / 110 \text{ VDC}$

Max. Strom .....  $0,5 \text{ AAC} / 0,3 \text{ ADC}$

Max. Leistung.....  $62,5 \text{ VA} / 32 \text{ W}$

## Marine-Zulassung:

Det Norske Veritas, Ships & Offshore ..... Angefordert

**GOST R Zulassung:**VNIIFTRI, Cert No..... Siehe [www.prelectronics.de](http://www.prelectronics.de)**SIL-Certifizierung:**

exida, Cert No. .... PREI 070902 P0002 C03.01

**Eingehaltene Richtlinien:**

EMV 2004/108/EG..... EN 61326-1

LVD 2006/95/EG..... EN 61010-1

ATEX 94/9/EG..... EN 60079-0, -11, -15, -26  
und EN 61241-0, -11IECEX..... IEC 60079-0, -11, -15 og -26  
IEC 61241-0 und -11

c FM us ..... FM 3600, 3611, 3810

CSA E60079-0, -15

CSA 22.2 -25, -142, -213

ANSI/ISA-12.00.01 / 12.12.02

UL, Standard for Safety ..... UL 61010-1

SIL ..... IEC 61508

**d. Messspanne** = der momentan gewählten Messspanne

## Konfiguration der Sensorfehlerüberprüfung

Sensorfehlerüberprüfung:		
Gerät:	Konfiguration	Fühlerfehlererkennung
9113	OUT.ERR=NONE.	OFF
	Sonst:	ON

## Visualisierung im 4501:

### Eingangssignal außerhalb des Bereichs

Außerhalb des Bereichs Anzeige (IN.LO, IN.HI): Bei Verlassen des Gewählten Bereichs des A/D-Wandlers oder des Polynoms			
Eingang	Bereich	Anzeige	Grenze
CURR	0...20 mA / 4...20 mA	IN.LO	< -1,05 mA
		IN.HI	> 25,05 mA
TEMP	TE / WTH	IN.LO	< Temperaturbereich -2°C
		IN.HI	> Temperaturbereich +2°C

Display Anzeige unter Min. / über Max. (-1999, 9999):			
Eingang	Bereich	Anzeige	Grenze
Alle	Alle	-1999	Display Anzeige <-1999
		9999	Display Anzeige >9999

### Fühlerfehlererkennung

Fühlerfehlererkennung (SE.BR, SE.SH):			
Eingang	Bereich	Anzeige	Grenze
CURR	Schleife unterbrochen (4...20 mA)	SE.BR	<= 3,6 mA; > = 20,75 mA
TEMP	TE	SE.BR	> 10 kΩ...165 kΩ
		SE.SH	< ca. 15 Ω
	WTH: 2-, 3- und 4-Leiter Für Pt10, Pt20, Pt50, Pt100, Pt200, Ni50 und Ni120	SE.BR	> 900...1000 Ω (Leiter > 50 Ω)
		SE.SH	< ca. 15 Ω
WTH: 2-, 3- und 4-Leiter für Pt250, Pt300, Pt400, Pt500, Pt1000 und Ni1000	SE.BR	> 10...12 kΩ (Leiter > 50 Ω)	
	SE.SH	< ca. 15 Ω	

### Fehleranzeige

Anzeige bei Hardwarefehler		
Fehlersuche	Anzeige	Fehlergrund
Eingang unterschritten	IN.LO	Siehe Bedingungen oben
Eingang überschritten	IN.HI	Siehe Bedingungen oben
Sensor Drahtbruch	SE.BR	Siehe Bedingungen oben
Sensor Kurzschluss	SE.SH	Siehe Bedingungen oben
Test des internen CJC-Fühlers	CJ.ER	Interner CJC-Fühler defekt oder Temp. außerh. des Bereichs**
CJC-Anschlussklemmen-Fehler - überprüfe CJC-Klemmenblock	CJ.CE	Defekte oder fehlende CJC-Anschlussklemme, Temperatur außerhalb des zulässigen Bereiches

Anzeige bei Hardware Fehler		
Fehlersuche	Anzeige	Grund
Eingangs-Fehler - Verbindungen kontrollieren und Versorgung kurz unterbrechen	IN.ER	Eingangssignalwerte außerhalb des Bereichs oder an falsche Klemmen angeschlossen*
Fehler im analogen Ausg. - Verbindungen kontrollieren und Versorgung kurz unterbrechen	AO.ER	Fehler im analogen Stromausgang (nur SIL-Modus)*
Keine Kommunikation	NO.CO	Keine Kommunikation zwischen Gerät und Frontdisplay 4501
FLASH Memory Fehler - Konfiguration kontrollieren	FL.ER CO.ER	FLASH-Fehler (Konfiguration ungültig)***
Ungültige Konfiguration oder Version	TY.ER	Konfiguration vom EEPROM hat einen ungültigen Wert oder Revisionsnummer
Hardware Fehler	RA.ER	RAM Fehler*
Hardware Fehler	IF.ER	Interner FLASH-Fehler*
Hardware Fehler	SW.ER	SW-Monitor-Fehler*
Hardware Fehler	AD.ER	Fehler A/D-Wandler*
Hardware Fehler	AO.SU	Fehler der Analogausgangs-Versorgung*
Hardware Fehler	CA.ER	Werkseitiger Kalibrierungsfehler*
Hardware Fehler	CM.ER	CPU Fehler*
Hardware Fehler	II.ER	Fehler in der Überprüfung der Initialisierung*
Hardware Fehler	RS.ER	Reset-Fehler*
Hardware Fehler	IC.ER	Kommunikationsfehler im Eingang*
Hardware Fehler	M1.ER	CPU Fehler Kanal 1*
Hardware Fehler	M2.ER	CPU Fehler Kanal 2*
Hardware Fehler	MC.ER	CPU Konfigurations-Fehler*
Hardware Fehler	MF.ER	CPU FLASH-Fehler*
Hardware Fehler	MR.ER	CPU RAM-Fehler*
Hardware Fehler	MS.ER	CPU Spannungsversorgungs-Fehler*
Hardware Fehler	MP.ER	CPU ProgFlow-Fehler**

- ! Alle Fehleranzeigen im Display blinken im Sekundentakt. Der Hilfstext erklärt den Fehler.
- \* Fehler wird entweder durch Durchschalten der Grundeinstellungen oder durch Wegnahme der Versorgungsspannung zurück gesetzt!  
Einige Fehler können nur durch Wegnahme der Versorgungsspannung zurück gesetzt werden.
- \*\* Fehler wird entweder durch Durchschalten der Grundeinstellungen oder durch Wegnahme der Versorgungsspannung zurück gesetzt!  
Fehler greift nur bei TE-Eingang.
- \*\*\* Fehler wird durch Durchschalten der Grundeinstellungen zurück gesetzt.

# ANSCHLÜSSE

Power Rail Verbindungen

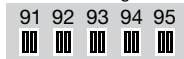

Fehler-Signal +24 V

Erde NC NC

NC = keine Verbindung

Versorgung und Statusrelais

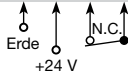
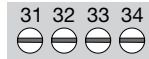

## Eingänge

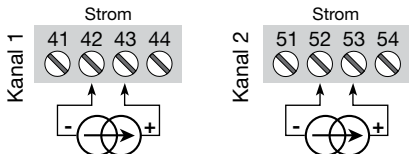
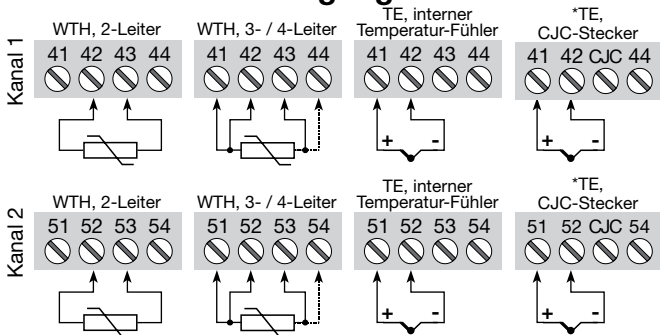

\* Bitte die CJC-Anschlussstecker 5910Ex (Kanal 1) / 5913Ex (Kanal 2) separat bestellen.

## Ausgänge

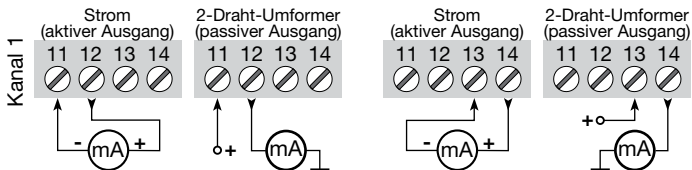

# BLOCKDIAGRAMM

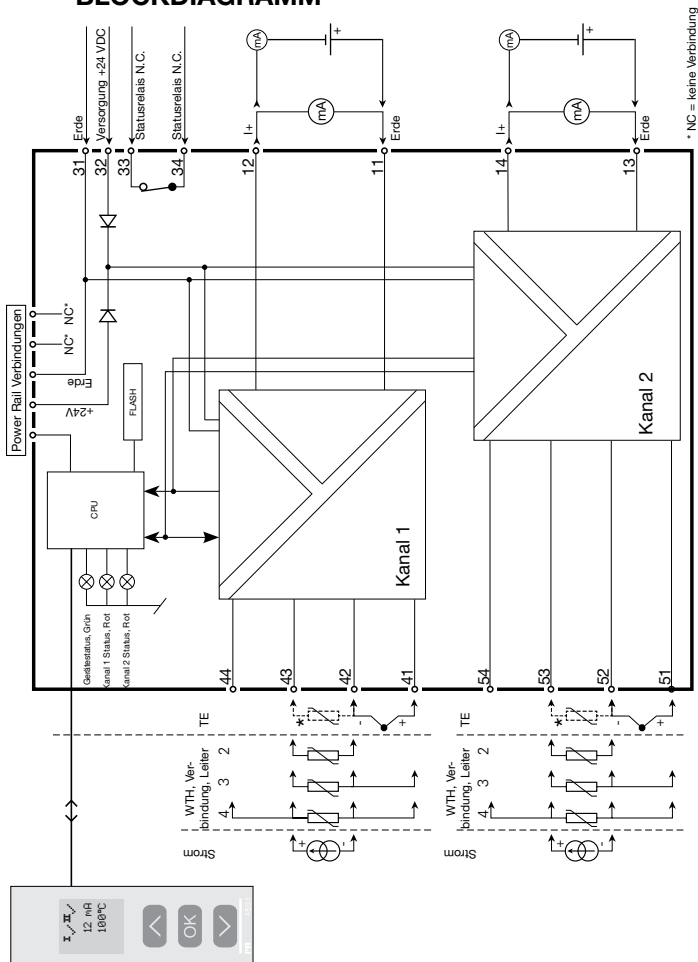

9113

# Signalfehler- und Kabelfehler Erkennung ohne Frontdisplay

Liste der LED und Fehlersignalanzeigen						
Status	Grüne LED	Kanal 1: Rote LED	Kanal 2: Rote LED	Statusrelais, N.C.	Power Rail Signalstatus	
Gerät OK	Blinkt	OFF	OFF	Angesteuert	Offen	
Keine Versorgung	OFF	OFF	OFF	Abgefallen	Geschlossen	
Gerät defekt	OFF	ON	ON	Abgefallen	Geschlossen	
Kanal 1 defekt (Kanal 2 OK)	Blinkt	ON	OFF	Abgefallen	Geschlossen	
Kanal 2 defekt (Kanal 1 OK)	Blinkt	OFF	ON	Abgefallen	Geschlossen	
Kanal 1, Signal OK	Blinkt	OFF	OFF	Angesteuert	Offen	
Kanal 1, Kabel Kurzschluss / Bruch	Blinkt	Blinkt	OFF	Abgefallen	Geschlossen (wenn aktiviert)	
Kanal 2, Signal OK	Blinkt	OFF	OFF	Angesteuert	Offen	
Kanal 2, Kabel Kurzschluss / Bruch	Blinkt	OFF	Blinkt	Abgefallen	Geschlossen (wenn aktiviert)	

# KONFIGURATION / BEDIENUNG DER FUNKTIONSTASTEN

Dokumentation für das Flussdiagramm.

## Grundsätzliches

Bei der Konfiguration des 9113 werden Sie durch alle Parameter geleitet und Sie können die Einstellungen wählen, welche zur Applikation passt. Für jedes Menü existiert ein scrollender Hilfetext welcher automatisch in der 3. Zeile im Display gezeigt wird.

Die Konfiguration wird mittels der 3 Funktionstasten durchgeführt:

- ⬆ erhöht den numerischen Wert oder wählt nächsten Parameter
- ⬇ setzt den numerischen Wert herab oder wählt nächsten Parameter
- Ⓞ übernimmt den gewählten Wert und beendet das Menü

Wenn eine Konfiguration eingegeben worden ist, kehrt das Display auf den Menüpunkt 1.0 zurück.

Bei drücken und halten von Ⓞ springt man zurück zum vorherigen Menü oder in den Normal-Zustand (1.0) ohne die geänderten Werte oder Parameter zu speichern.

Wenn für 1 Minute keine Taste betätigt wird, geht das Display in den Normal-Zustand zurück, ohne die geänderten Werte oder Parameter zu speichern.

## Weitere Erklärungen

**Passwordschutz:** Der Zugriff auf die Programmierung kann mit der Eingabe eines Passwortes blockiert werden. Das Passwort wird im 9113 gespeichert, um den höchsten Grad an Schutz gegen nicht autorisierte Änderungen der Konfiguration sicherzustellen. Bei Eingabe des Master-Passwortes 2008 sind alle Konfigurationsmenüs erreichbar.

## Auswahl der Einheiten

Wenn man Temperatursignal als Eingangsparameter auswählt, kann man auch auswählen, welchem Prozesswert angezeigt wird (siehe Tabelle). Der Wert wird in °C oder °F angezeigt. Dieses wird nach Auswahl des Temperatureingangs im Menüpunkt ausgewählt.

## CJC

Im CJC-Menü haben Sie die Wahl zwischen externer und interner Kaltstellenkompensation (CJC). Die externe CJC-Anschlussklemme PR 5910Ex/5913Ex muss separat bestellt werden.

### Signal- und Sensorfehlerinformation per Programmierfront 4501

Sensorfehler (s. Grenzen im Diagramm), wird als SE.BR (Sensorfehler) oder SE.SH (Fühlerkurzschluß) angezeigt. Signale, ausserhalb des gewählten Bereichs (kein Sensorfehler, s. Tabelle für Grenzen), werden als IN.LO (niedriges Eingangssignal) oder IN.HI (hohes Eingangssignal) angezeigt. Die Fehlermeldung wird als Text in der 2. Zeile für Kanal1 und der 3. Zeile für Kanal 2 mit blinkender Hintergrundbeleuchtung angezeigt. Zeile 4 der Anzeige zeigt den Status der SIL-Konfiguration (Statischer Punkt = SIL-verriegelt, blinkender Punkt = nicht SIL-verriegelt) an. COM (Kugelsymbol mit laufendem Kreis) zeigt an, ob das 4501 korrekt funktioniert.

### Signal und Sensorfehleranzeige ohne Programmierfront

Der Gerätestatus kann auch von den 3 LEDs an der Vorderseite des Gerätes abgelesen werden.

Grün blinkende LED zeigt normalen Betrieb an.

Grüne LED leuchtet nicht bedeutet keine Versorgungsspannung oder Gerätefehler.

Dauernd rot leuchtende LED signalisiert einen schwerwiegenden Fehler.

Rot blinkende LED zeigt Sensorfehler an.

### Hauptfunktionen

Das Gerät bietet Zugang zu verschiedenen Funktionen, welche mit "YES" bei der Abfrage „ADV.SET“ bestätigt werden muß.

**Anzeigeeinstellungen:** Sie können Werte einstellen, wie Displaykontrast und Hintergrundhelligkeit. Einstellung der TAG-Nummer mit 5 alphanumerischen Werten. Auswahl der Anzeigefunktion in der dritten Zeile zwischen Analogeingang, Analogausgang oder TAG Nummer, oder wechselnde Information.

**Zweipunkt Prozesskalibrierung:** Mit dem Gerät kann mit zwei Punkten des Eingangssignals eine Prozesskalibrierung durchgeführt werden. Ein niedriges Eingangssignal (0% nicht unbedingt nötig) muss anliegen und der aktuelle Wert wird übernommen. Dann wird ein höherer Wert (nicht unbedingt 100%) eingelesen. Wenn Sie die Kalibrierung akzeptieren, wird das Gerät mit den neuen Werten übernommen. Wenn Sie später diese Werte verwerfen oder andere Parameter eingeben, wird die Werkskalibrierung übernommen.

**Prozesssimulationsfunktion:** Wenn Sie die Abfrage "EN.SIM" bestätigen, ist es möglich ein Eingangssignal zu simulieren, d.h. die hoch/runter Tasten kontrollieren das Ausgangssignal.. Das Menu kann nur verlassen werden beim Drücken auf 3 (keine Zeitauslösung). Das Simulierungsfunktion wird automatisch verlassen, wenn das 4501 entfernt wird.

**Passwort:** Sie können ein Passwort zwischen 0000 und 9999 einstellen, um ein unbefugtes Verändern der Parameter zu vermeiden. Das Gerät wird werksseitig ohne Passwordeingabe ausgeliefert.

**Sprache:** Im Menü "lang.setup" können Sie zwischen 7 verschiedenen Sprachen auswählen, die Sie mit Hilfetexten unterstützen. Sie können auswählen zwischen: UK, DE, FR, IT, ES, SE und DK.

**Power Rail:** Im Menü "Rail" können Sie wählen, ob Sensor-Fehler an die zentrale Überwachung im Power Control Unit PR 9410 weitergegeben werden sollen.

**Safety Integrity Level (SIL):** Für Details sehen Sie bitte im Sicherheitshandbuch (Safety Manual) nach.



# FLUSSDIAGRAMM

Wenn für eine Dauer von 1 Minute keine Taste betätigt wird, kehrt das Display auf den Menüpunkt 1.0 zurück und eventuelle Änderungen in der Konfiguration werden nicht gespeichert.

⊖ Wert erhöhen / nächsten Parameter wählen

⊕ Wert herabsetzen / vorherigen Parameter Wählen

⊙ Parameter speichern und nächsten Parameter wählen

Halten ⊞ Zurück zum vorherigen Parameter / zurück zum Menüpunkt 1.0 ohne Speicherung von Änderungen

Power up



1.0

Wenn SIL-verriegelt  
direkt zu [EN.SIL]

0000  
9999

NO  
YES

CURR  
TEMP

4-20  
0-20

20-4  
20-0  
4-20  
0-20

23mA  
0/3.5mA  
NONE

0000  
PASSW.  
Txt 1

NO  
ADV.SET  
Txt 2

CURR  
CHI TYPE  
Txt 3

4-20  
I RANGE  
Txt 4

4-20  
O RANGE  
Txt 12

23  
OUT.ERR  
Txt 13

1.1

1.2

1.0 = Normal-Zustand. Zeile 1 zeigt das Eingangstatus, Zeile 2 und 3 zeigen den Analogeingang, Analogausgang oder den Geräte-TAG und die Einheiten, und Zeile 4 den Status der SIL-Konfiguration (offen / verriegelt) an. Statischer Punkt = SIL-verriegelt, blinkender Punkt = nicht SIL-verriegelt. Zeile 4 zeigt auch den Kommunikationsstatus an.

1.1 = Nur wenn durch Passwort gesichert.

1.2 = Nicht gültig für folgende Eingangssignale: 0...20 mA.

1.3 = Nur wenn Eingangssignal Temperatur. Min. und Max. gemäß gewählten Sensortyp

1.4 = Nur wenn die Konfiguration nicht durch Passwort gesichert ist

Roter Text bedeutet Sicherheitsparameter in einer SIL Konfiguration. Siehe Sicherheitshandbuch (Safety Manual) für Details.



Fortsetzung auf Seite 96  
Flussdiagramm ADV.SET

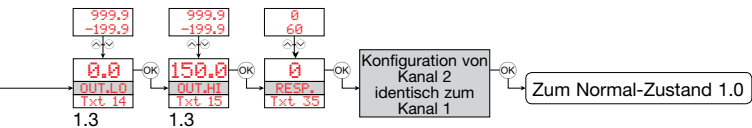

# FLUSSDIAGRAMM, ERWEITERTE EINSTELLUNGEN (ADV.SET)

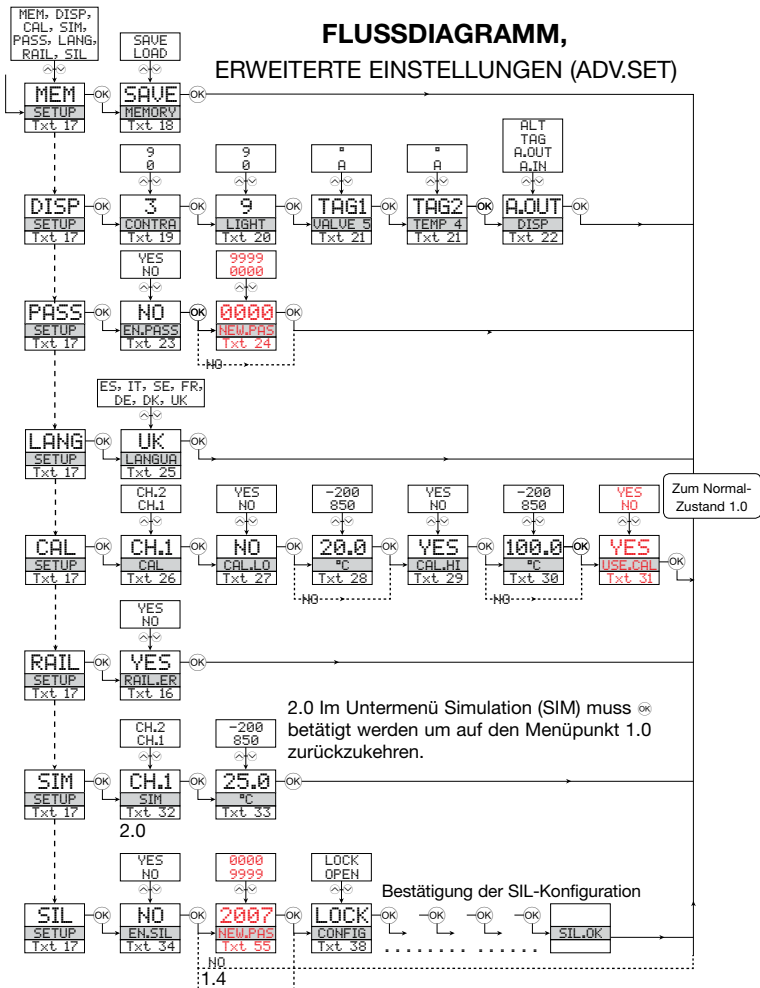

## SCROLLENDER HILFSTEXT IM DISPLAY ZEILE 3

- [01] Einstellung des korrekten Passwortes
- [02] Eingabe erweiterter Setup Menü?
- [03] Auswahl Temperatur-Eingang  
Auswahl Stromeingang
- [04] Wähle 0-20 mA Eingangsbereich  
Wähle 4-20 mA Eingangsbereich
- [05] Wähle TE Sensor Typ  
Wähle Ni Sensor Typ  
Wähle Pt Sensor Typ
- [06] Wähle Pt10 als Sensor Typ  
Wähle Pt20 als Sensor Typ  
Wähle Pt50 als Sensor Typ  
Wähle Pt100 als Sensor Typ  
Wähle Pt200 als Sensor Typ  
Wähle Pt250 als Sensor Typ  
Wähle Pt300 als Sensor Typ  
Wähle Pt400 als Sensor Typ  
Wähle Pt500 als Sensor Typ  
Wähle Pt1000 als Sensor Typ
- [07] Wähle Ni50 als Sensor Typ  
Wähle Ni100 als Sensor Typ  
Wähle Ni120 als Sensor Typ  
Wähle Ni1000 als Sensor Typ
- [08] Wähle TC-B als Sensor Typ  
Wähle TC-E als Sensor Typ  
Wähle TC-J als Sensor Typ  
Wähle TC-K als Sensor Typ  
Wähle TC-L als Sensor Typ  
Wähle TC-N als Sensor Typ  
Wähle TC-R als Sensor Typ  
Wähle TC-S als Sensor Typ  
Wähle TC-T als Sensor Typ  
Wähle TC-U als Sensor Typ  
Wähle TC-W3 als Sensor Typ  
Wähle TC-W5 als Sensor Typ  
Wähle TC-Lr als Sensor Typ
- [09] Wähle 2-Leiter Sensoranschluss  
Wähle 3-Leiter Sensoranschluss  
Wähle 4-Leiter Sensoranschluss
- [11] Wähle Celsius als Temperatureinheit  
Wähle Fahrenheit als Temperatureinheit
- [12] Wähle 0-20 mA Ausgangsbereich  
Wähle 4-20 mA Ausgangsbereich  
Wähle 20-0 mA Ausgangsbereich  
Wähle 20-4 mA Ausgangsbereich
- [13] Wähle Keine Fehlerwirkung - Ausgang undefiniert bei Fehler  
Wähle Downscale bei Fehler  
Wähle NAMUR NE43 Downscale bei Fehler  
Wähle NAMUR NE43 Upscale bei Fehler
- [14] Einstellung Temperatur für Analogausgang LOW
- [15] Einstellung Temperatur für Analogausgang HIGH
- [16] Aktivierung Power Rail Statussignal?
- [17] Eingabe SIL Einstellungen  
Eingabe Simulationsmodus  
Eingabe Power Rail Einstellungen  
Prozesskalibrierung ausführen  
Eingabe Sprachauswahl  
Eingabe Passwort Einstellung  
Eingabe Display Einstellung  
Memory Operationen Ausführen
- [18] Lade gespeicherte Konfiguration in das Gerät  
Konfiguration in der Displayfront speichern
- [19] Einstellung LCD Kontrast
- [20] Einstellung LCD Hintergrundbeleuchtung
- [21] Schreibe eine 5-Zeichen Geräte TAG Nummer
- [22] Analoge Eingangswert wird im Display angezeigt  
Analoge Ausgangswert wird im Display angezeigt  
Geräte TAG Nummer wird im Display angezeigt  
Wechselnde Information im Display
- [23] Ermögliche Passwortschutz
- [24] Eingabe Neuen Passworts
- [25] Wähle Sprache
- [26] Wähle Kanal für Kalibrierung
- [27] Kalibriere Input Low zum Prozesswert
- [28] Eingabe des Wertes für den unteren Kalibrierungspunkt
- [29] Kalibriere Input High zum Prozesswert?
- [30] Eingabe des Wertes für den oberen Kalibrierungspunkt
- [31] Verwende Prozesskalibrierungswerte?
- [32] Wähle Kanal für Simulierung
- [33] Eingabe den Eingangs-Simulationswert
- [34] Aktivierung der SIL Konfiguration verriegeln?  
0-20 mA ist nicht gültiger Ausgangsbereich im SIL Betrieb
- [35] Wähle Ansprechzeit für Analogausgang in Sekunden
- [36] Wähle Interner Temperatur Sensor  
Wähle CJC-Stecker (Zubehör)
- [37] ... Benutzt der Kanal Prozesskompensierte Kalibrierungswerte?
- [38] Konfiguration SIL Status (offen / verriegeln)
- [40] Sensor Drahtbruch
- [41] Sensor Kurzschluss
- [42] Eingang unterschritten
- [43] Eingang überschritten
- [44] Eingangs-Fehler - Verbindungen kontrollieren und Versorgung kurz unterbrechen
- [45] Fehler im analogen Ausgang - Verbindungen kontrollieren und Versorgung kurz unterbrechen
- [46] FLASH Memory Fehler - Konfiguration kontrollieren
- [47] Ungültige Konfiguration oder Version
- [48] Hardware-Fehler
- [49] CJC Fehler - Geräte-Temperatur kontrollieren
- [50] CJC Fehler - CJC Stecker Terminal kontrollieren
- [51] Keine Kommunikation

# **APPENDIX**

**IECEX INSTALLATION DRAWING  
ATEX INSTALLATION DRAWINGS  
UK, FR, DE, DK  
FM INSTALLATION DRAWING  
SAFETY MANUAL**

## IECEx Installation drawing

**9113**

For safe installation of 9113B the following must be observed. The module shall only be installed by qualified personnel who are familiar with the national and international laws, directives and standards that apply to this area.

Year of manufacture can be taken from the first two digits in the serial number.

**4501**

For Installation in Zone 2 / Division 2 the following must be observed.

The 4501 programming module is to be used solely with PR electronics modules. It is important that the module is undamaged and has not been altered or modified in any way. Only 4501 modules free of dust and moisture shall be installed.

IECEx Certificate: .....KEM 09.0052 X

Marking  
 Ex nA nC IIC T4 Gc  
 [Ex ia Ga] IIC/IIB/IIA  
 [Ex ia Da] IIIC

Standards  
 IEC60079-15 :2005, IEC60079-11:2006, IEC60079-0: 2007  
 IEC60079-26: 2006, IEC61241-0: 2004, IEC61241-11:2005

Hazardous area  
 Zone 0,1,2, 20, 21, 22

Non Hazardous area  
 or Zone 2

$-20 \leq T_a \leq +60^{\circ}\text{C}$

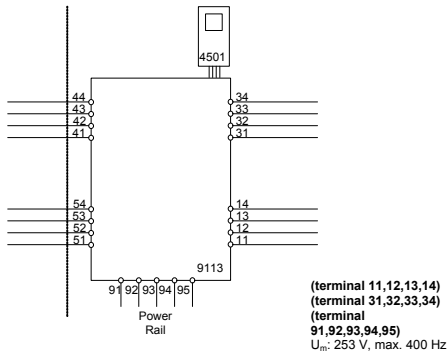

LERBAKKEN 10, 8410 RØNDE DENMARK

**Ex input****CH1 (terminal 41,42,43,44)****CH2 (terminal 51,52,53,54)**

U<sub>o</sub>: 8.7 V  
I<sub>o</sub>: 18.4 mA  
P<sub>o</sub>: 40 mW  
Lo/Ro 892 μH/Ω

	IIC	IIB	IIA
C <sub>o</sub>	5 μF	50 μF	1000 μF
L <sub>o</sub>	100 mH	300 mH	700 mH

U<sub>i</sub>: 10 V  
I<sub>i</sub>: 30 mA  
C<sub>i</sub>: 30 nF  
L<sub>i</sub>: 820 nH

**Status Relay. terminal (33,34)**

Voltage max.: 125 VAC / 110 VDC  
Power max.: 62.5 VA / 32 W  
Current max.: 0.5 A AC / 0.3 ADC

**Zone 2 installation:**

Voltage max.: 32 VAC / 32 VDC  
Power max.: 16 VA / 32 W  
Current max.: 0.5 A AC / 1 ADC

**Installation notes:**

For installation in Zone 2, the module must be installed in an outer enclosure having an IP protection of at least IP54 conforming to the requirements of IEC60079-15.

For installation on Power Rail in Zone 2, only Power Rail type 9400 supplied by Power Control Unit type 9410 is allowed.

In type of protection "intrinsic safety iD" the parameters for intrinsic safety for gas group IIB are applicable.

After the sensor circuits (Terminals 41..44, 51..54) have been installed in a type of protection, other than "intrinsic safety" the module shall not be re-installed in type of protection "intrinsic safety"

Do not separate connectors when energized and an explosive gas mixture is present.

Do not mount or remove modules from the Power Rail when an explosive gas mixture is present.

LERBAKKEN 10, 8410 RØNDE DENMARK

 Hazardous area  
 Zone 0,1,2, 20, 21, 22

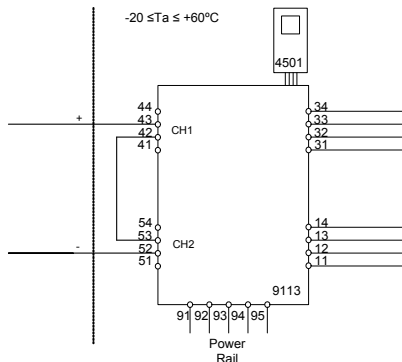
 Non Hazardous area  
 or Zone 2

**Ex input**
**CH1 (terminal 43 +)**
**CH2 (terminal 52 -)**
 $U_o:$  17.4 V

 $I_o:$  18.4 mA

 $P_o:$  80 mW

 $Lo/Ro$  445  $\mu\text{H}/\Omega$ 

(terminal 11,12,13,14)

(terminal 31,32,33,34)

(terminal

**91,92,93,94,95)**
 $U_m:$  253 V, max. 400 Hz

	IIC	IIB	IIA
$C_o$	0.3 $\mu\text{F}$	1.6 $\mu\text{F}$	8 $\mu\text{F}$
$L_o$	80 mH	250 mH	600 mH

 $U_i:$  10 V

 $I_i:$  30 mA

 $C_i:$  15 nF

 $L_i:$  1.7  $\mu\text{H}$

## ATEX Installation drawing

**9113**

For safe installation of 9113B the following must be observed. The module shall only be installed by qualified personnel who are familiar with the national and international laws, directives and standards that apply to this area.

Year of manufacture can be taken from the first two digits in the serial number.

**4501**

For Installation in Zone 2 / Division 2 the following must be observed.

The 4501 programming module is to be used solely with PRElectronics modules. It is important that the module is undamaged and has not been altered or modified in any way. Only 4501 modules free of dust and moisture shall be installed.

ATEX Certificate: .....KEMA 07ATEX 0148 X

Marking:.....



II 3 G Ex nA nC IICT4  
II (1) G [Ex ia] IIC/IIB/IIA  
II (1) D [Ex iaD]

Hazardous area  
Zone 0,1,2, 20, 21, 22

Non Hazardous area  
or Zone 2  
 $-20 \leq T_a \leq +60^{\circ}\text{C}$

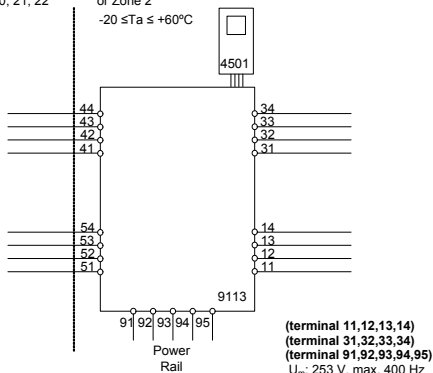

LERBAKKEN 10, 8410 RØNDE DENMARK

**Ex input****CH1 (terminal 41,42,43,44)****CH2 (terminal 51,52,53,54)**

U<sub>o</sub>: 8.7 V  
I<sub>o</sub>: 18.4 mA  
P<sub>o</sub>: 40 mW  
L<sub>o</sub>/R<sub>o</sub>: 892 μH/Ω

	IIC	IIB	IIA
C <sub>o</sub>	5 μF	50 μF	1000 μF
L <sub>o</sub>	100 mH	300 mH	700 mH

U<sub>i</sub>: 10 V  
I<sub>i</sub>: 30 mA  
C<sub>i</sub>: 30 nF  
L<sub>i</sub>: 820 nH

**Status Relay. terminal (33,34)**

Voltage max.: 125 VAC / 110 VDC  
Power max.: 62.5 VA / 32 W  
Current max.: 0.5 A AC / 0.3 ADC

**Zone 2 installation:**

Voltage max.: 32 VAC / 32 VDC  
Power max.: 16 VA / 32 W  
Current max.: 0.5 A AC / 1 ADC

**Installation notes:**

For installation in Zone 2, the module must be installed in an outer enclosure having an IP protection of at least IP54 conforming to the requirements of EN60079-15.

For installation on Power Rail in Zone 2, only Power Rail type 9400 supplied by Power Control Unit type 9410 (Type Examination Certificate KEMA 07ATEX0152 X) is allowed.

In type of protection "intrinsic safety iD" the parameters for intrinsic safety for gas group IIB are applicable.

After the sensor circuits (Terminals 41..44, 51..54) have been installed in a type of protection, other than "intrinsic safety" the module shall not be re-installed in type of protection "intrinsic safety"

Do not separate connectors when energized and an explosive gas mixture is present.

Do not mount or remove modules from the Power Rail when an explosive gas mixture is present.

LERBAKKEN 10, 8410 RØNDE DENMARK

 Hazardous area  
 Zone 0,1,2, 20, 21, 22

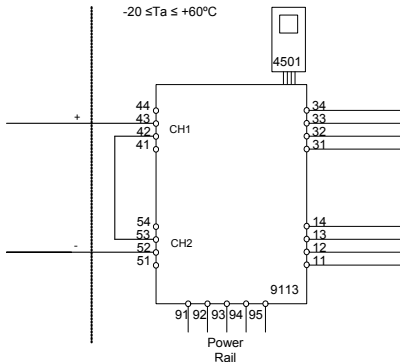
 Non Hazardous area  
 or Zone 2  
 $-20 \leq T_a \leq +60^\circ\text{C}$ 

**Ex input**
**CH1 (terminal 43)**
**CH2 (terminal 52)**
 $U_o:$  17,4 V

 $I_o:$  18.4 mA

 $P_o:$  80 mW

 $L_o/R_o$  445  $\mu\text{H}/\Omega$ 

(terminal 11,12,13,14)

(terminal 31,32,33,34)

(terminal 91,92,93,94,95)

 $U_m:$  253 V, max. 400 Hz

	IIC	IIB	IIA
$C_o$	0.3 $\mu\text{F}$	1.6 $\mu\text{F}$	8 $\mu\text{F}$
$L_o$	80 mH	250 mH	600 mH

 $U_i:$  10 V

 $I_i:$  30 mA

 $C_i:$  15 nF

 $L_i:$  1.7  $\mu\text{H}$

## Schéma d'installation ATEX

**9113**

Pour une installation sûre du 9113B vous devez observer ce qui suit. Le module sera seulement installé par un personnel qualifié qui est informé des lois, des directives et des normes nationales et internationales qui s'appliquent à ce secteur. L'année de la fabrication est indiquée dans les deux premiers chiffres dans le numéro de série.

**4501**

Pour l'installation dans la zone 2 / Division 2 on doit observer ce qui suit. Le module de programmation 4501 doit être employé seulement avec des modules de PR electronics. Il est important que le module soit intact et n'ait pas été changé ou n'ait pas été modifié de quelque façon que se soit. Le module 4501 doit être exempt des zones de poussières et d'humidité lorsqu'il est installé.

Certificat ATEX : .....KEMA 07ATEX 0148 X

Marquage : .....



II 3 G Ex nA nC IICT4  
 II (1) G [Ex ia] IIC/IIIB/IIA  
 II (1) D [Ex iaD]

Zone dangereuse  
 Zone 0,1,2, 20, 21, 22

Zone non dangereuse  
 ou Zone 2  
 $-20 \leq T_a \leq +60^{\circ}\text{C}$

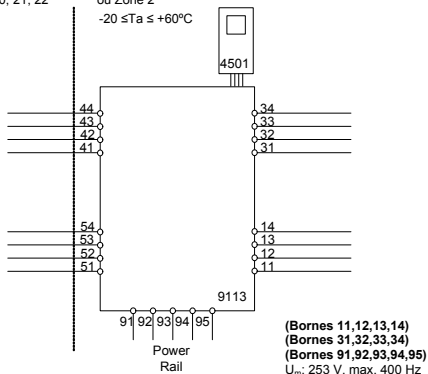

LERBAKKEN 10, 8410 RØNDE DENMARK

**Entrée Ex****Voie 1 (bornes 41,42,43,44)****Voie 2 (bornes 51,52,53,54)**

$U_0$ : 8,7 V  
 $I_0$ : 18.4 mA  
 $P_0$ : 40 mW  
 $L_0/R_0$ : 892  $\mu$ H/ $\Omega$

	IIC	IIB	IIA
$C_0$	5 $\mu$ F	50 $\mu$ F	1000 $\mu$ F
$L_0$	100 mH	300 mH	700 mH

$U_i$ : 10 V  
 $I_i$ : 30 mA  
 $C_i$ : 30 nF  
 $L_i$ : 820 nH

**Relais d'état, bornes (33,34)**

Tension max. : 125 Vca / 110 Vcc  
Puissance max. : 62,5 VA / 32 W  
Courant max. : 0,5 A ca / 0,3 Acc

Installation en Zone 2 :

Tension max. : 32 Vca / 32 Vcc  
Puissance max. : 16 VA / 32 W  
Courant max. : 0,5 A ca / 1 A cc

**Notes d'installation :**

Pour l'installation dans la zone 2, le module doit être installé dans une enceinte externe ayant une protection d'étanchéité au moins d'IP54, selon les exigences d'EN60079-15.

Pour l'installation avec le rail d'alimentation dans la zone 2, on doit utiliser seulement le bloc d'alimentation du rail type 9400 ainsi que le contrôleur de puissance type 9410 (Attestation d'examen de type KEMA 07ATEX0152 X).

Selon le type de protection « sécurité intrinsèque iD » les paramètres pour la sécurité intrinsèque pour le gaz IIB s'appliquent.

Après les circuits de sonde (bornes 41..44, 51..54) ont été installés dans les autres types de protection autre que « la sécurité intrinsèque », le module ne peut pas être réinstallé dans le type de protection « sécurité intrinsèque ».

Ne déconnecter pas les connecteurs une fois activé et dans un environnement en présence de gaz. Ne montez pas ou n'enlevez pas les modules du rail d'alimentation est présence d'un mélange de gaz.

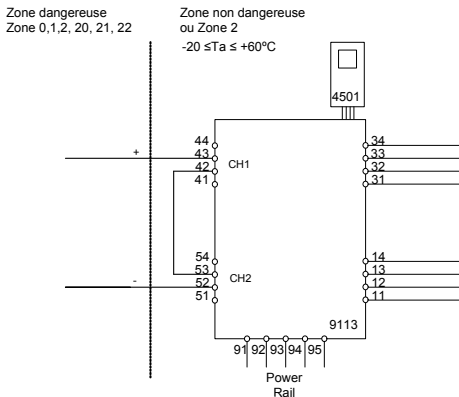
**Entrée Ex**
**Voie 1 (borne 43)**
**Voie 2 (borne 52)**

$U_o$ : 17,4 V  
 $I_o$ : 18,4 mA  
 $P_o$ : 80 mW  
 $Lo/Ro$ : 445  $\mu\text{H}/\Omega$

**(Bornes 11,12,13,14)**  
**(Bornes 31,32,33,34)**  
**(Bornes 91,92,93,94,95)**  
 $U_m$ : 253 V, max. 400 Hz

	IIC	IIB	IIA
$C_o$	0,3 $\mu\text{F}$	1,6 $\mu\text{F}$	8 $\mu\text{F}$
$L_o$	80 mH	250 mH	600 mH

$U_i$ : 10 V  
 $I_i$ : 30 mA  
 $C_i$ : 15 nF  
 $L_i$ : 1..7  $\mu\text{H}$

## ATEX Installationszeichnung

**9113**

Für die sichere Installation von 9113B ist Folgendes zu beachten: Das Gerät darf nur von qualifiziertem Personal eingebaut werden, das mit den nationalen und internationalen Gesetzen, Richtlinien und Standards auf diesem Gebiet vertraut ist.  
Das Baujahr kann aus den ersten beiden Ziffern der Seriennummer ersehen werden.

**4501**

Für die Installation in Zone 2 / Division 2 ist Folgendes zu beachten:  
Das aufsteckbare Frontdisplay 4501 zur Programmierung ist ausschließlich mit PR electronics-Geräten zu verwenden. Es ist wichtig, dass das Display unbeschädigt ist, nicht umgebaut oder in irgendeiner Weise verändert wurde. Das 4501 darf nur frei von Staub und Feuchtigkeit installiert werden.

ATEX-Zertifikat: ..... KEMA 07ATEX 0148 X

Markierung:.....



II 3 G Ex nA nC IIC T4  
II (1) G [Ex ia] IIC/II B/IIA  
II (1) D [Ex iaD]

Ex-Bereich  
Zone 0,1,2, 20, 21, 22

Nicht-Ex-Bereich  
oder Zone 2

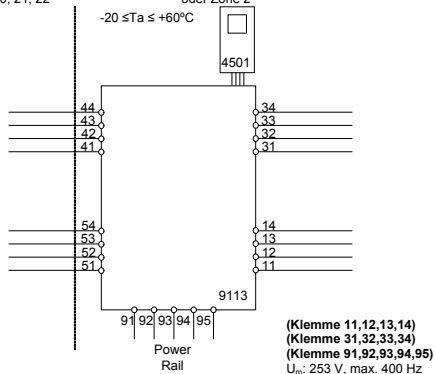

LERBAKKEN 10, 8410 RØNDE DENMARK

**Ex-Eingang****Kanal 1 (Klemme 41,42,43,44)****Kanal 2 (Klemme 51,52,53,54)**

U<sub>o</sub>: 8,7 V  
I<sub>o</sub>: 18,4 mA  
P<sub>o</sub>: 40 mW  
Lo/Ro 892 µH/Ω

	IIC	IIB	IIA
C <sub>o</sub>	5 µF	50 µF	1000 µF
L <sub>o</sub>	100 mH	300 mH	700 mH

U<sub>i</sub>: 10 V  
I<sub>i</sub>: 30 mA  
C<sub>i</sub>: 30 nF  
L<sub>i</sub>: 820 nH

**Statusrelais, Klemme (33,34)**

Spannung max: 125 VAC / 110 VDC  
Leistung max: 62,5 VA / 32 W  
Strom max: 0,5 A AC / 0,3 ADC

Zone 2-Installation:

Spannung max: 32 VAC / 32 VDC  
Leistung max: 16 VA / 32 W  
Strom max: 0,5 A AC / 1 ADC

**Installationsvorschriften:**

Für die Installation in Zone 2 muss das Gerät in einem Gehäuse der IP-Schutzart von mindestens IP54 in Übereinstimmung mit den Anforderungen von EN60079-15 eingebaut werden.

Für die Installation auf Power Rail in Zone 2 ist nur Power Rail Typ 9400 – in Verbindung mit dem Power Control Unit Typ 9410 (Baumusterprüfbescheinigung KEMA 07ATEX0152 X) - erlaubt.

Bei der Schutzart "Eigensicherheit iD" gelten die Parameter für die Eigensicherheit der Gas-Gruppe IIB.

Sind die Fühlerkreisläufe (Klemmen 41...44, 51...54) erst einmal in einer anderen Schutzart als "Eigensicherheit" installiert worden, darf das Gerät nach einem evtl. Ausbau nicht mit Schutzart "Eigensicherheit" wieder eingebaut werden.

Nicht die Anschlüsse trennen, solange ein Energie geladenes explosives Gasgemisch vorhanden ist. Montieren oder entfernen Sie nicht Geräte oder Baugruppen auf bzw. von der Power Rail, wenn ein explosives Gasgemisch vorhanden ist.

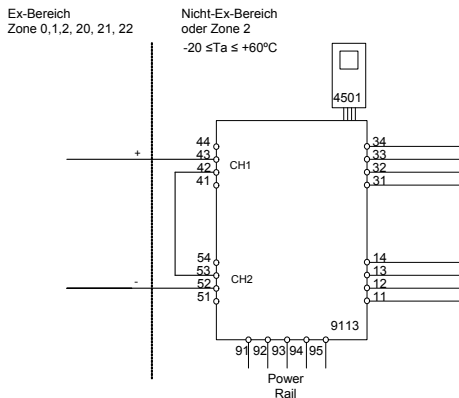
**Ex-Eingang**
**Kanal 1 (Klemme 43)**
**Kanal 2 (Klemme 52)**
 $U_o$ : 17,4 V

 $I_o$ : 18,4 mA

 $P_o$ : 80 mW

 $L_o/R_o$ : 445  $\mu\text{H}/\Omega$ 
**(Klemme 11,12,13,14)**
**(Klemme 31,32,33,34)**
**(Klemme 91,92,93,94,95)**
 $U_m$ : 253 V, max. 400 Hz

	IIC	IIB	IIA
$C_o$	0,3 $\mu\text{F}$	1,6 $\mu\text{F}$	8 $\mu\text{F}$
$L_o$	80 mH	250 mH	600 mH

 $U_i$ : 10 V

 $I_i$ : 30 mA

 $C_i$ : 15 nF

 $L_i$ : 1,7  $\mu\text{H}$

## ATEX Installationstegning

**9113**

For sikker installation af 9113B skal følgende overholdes: Modulet må kun installeres af kvalificerede personer, som er bekendt med national og international lovgivning, direktiver og standarder i det land, hvor modulet skal installeres. Produktionsår fremgår af de to første cifre i serienummeret.

**4501**

For installation i zone 2 skal følgende overholdes: Den aftagelige displayfront til programmering 4501 er udelukkende beregnet til brug på PR electronics moduler. Det er vigtigt, at displayet er ubeskadiget, ikke ombygget eller på anden måde forandret. 4501 må kun anvendes, hvis det er fri for støv og/eller fugt.



ATEX-certifikat: .....KEMA 07ATEX 0148 X

Mærkning:.....



II 3 G Ex nA nC IIC T4  
II (1) G [Ex ia] IIC/IIB/IIA  
II (1) D [Ex iaD]

Ex-område  
Zone 0,1,2, 20, 21, 22

Ikke Ex-område  
eller Zone 2  
-20 ≤ Ta ≤ +60°C

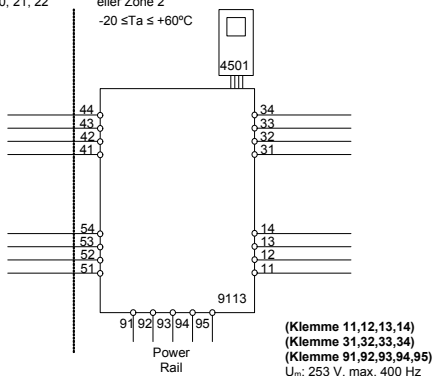

LERBAKKEN 10, 8410 RØNDE DENMARK

**Ex-indgang****Kanal 1 (klemme 41,42,43,44)****Kanal 2 (klemme 51,52,53,54)**

$U_o$ : 8,7 V  
 $I_o$ : 18,4 mA  
 $P_o$ : 40 mW  
 $L_o/R_o$ : 892  $\mu$ H/ $\Omega$

	IIC	IIB	IIA
$C_o$	5 $\mu$ F	50 $\mu$ F	1000 $\mu$ F
$L_o$	100 mH	300 mH	700 mH

$U_i$ : 10 V  
 $I_i$ : 30 mA  
 $C_i$ : 30 nF  
 $L_i$ : 820 nH

**Statusrelæ, klemme (33,34)**

Max. spænding: 125 VAC / 110 VDC  
Max. forbrug: 62,5 VA / 32 W  
Max. strøm: 0,5 A AC / 0,3 ADC

## Zone 2-installation:

Max. spænding: 32 VAC / 32 VDC  
Max. forbrug: 16 VA / 32 W  
Max. strøm: 0,5 A AC / 1 ADC

**Installationsforskrifter:**

For installation i zone 2 skal modulet installeres i et hus, som har en IP-beskyttelse på mindst IP54 i henhold til kravene i EN60079-15.

Ved installation på Power Rail type 9400 i zone 2 er det kun tilladt at forsyne Power Rail ved brug af 9410 Power Control Unit (Typeafprøvningsattest KEMA 07ATEX0152 X).

Ved beskyttelsesmetode „egensikker iD” er parametrene for egensikker gasgruppe IIB gældende.

Har sensorkredsløb (klemme 41...44, 51...54) først en gang været installeret som en anden beskyttelsesmetode end "egensikker", må modulet ikke geninstalleres som beskyttelsesmetode egensikker.

Monter/demonter ikke stik, når forsyning er tilsluttet og der forefindes en eksplosionsfarlig gasblanding.

Monter/demonter ikke modulet på Power Rail, når der forefindes en eksplosionsfarlig gasblanding.

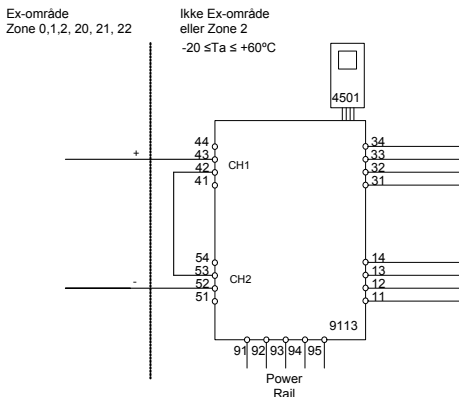
**Ex-indgang**
**Kanal 1 (klemme 43)**
**Kanal 2 (klemme 52)**

$U_o$ : 17,4 V  
 $I_o$ : 18,4 mA  
 $P_o$ : 80 mW  
 $Lo/Ro$ : 445  $\mu$ H/ $\Omega$

**(Klemme 11,12,13,14)**  
**(Klemme 31,32,33,34)**  
**(Klemme 91,92,93,94,95)**  
 $U_m$ : 253 V, max. 400 Hz

	IIC	IIB	IIA
$C_o$	0,3 $\mu$ F	1,6 $\mu$ F	8 $\mu$ F
$L_o$	80 mH	250 mH	600 mH

$U_i$ : 10 V  
 $I_i$ : 30 mA  
 $C_i$ : 15 nF  
 $L_i$ : 1,7 $\mu$ H

## FM Installation drawing

**9113**

For safe installation of 9113B the following must be observed. The module shall only be installed by qualified personnel who are familiar with the national and international laws, directives and standards that apply to this area.  
Year of manufacture can be taken from the first two digits in the serial number.

**4501**

For Installation in Zone 2 / Division 2 the following must be observed.  
The 4501 programming module is to be used solely with PR electronics modules. It is important that the module is undamaged and has not been altered or modified in any way.  
Only 4501 modules free of dust and moisture shall be installed.

FM Certificate: .....3038279

### Hazardous area

 Class I/II/III, Division 1, Group A,B,C,D,E,F,G  
or Class I, Zone 0/1 Group IIC

### Non Hazardous Area or

 Class I, Division 2, Group A,B,C,D T4  
or Class I, Zone 2 Group IIC T4

 Intrinsically safe apparatus  
entity parameters:

$$V_{max}(U_i) \geq V_t(U_o)$$

$$I_{max}(I_i) \geq I_t(I_o)$$

$$P_i \geq P_o$$

$$C_a \geq C_{cable} + C_i$$

$$L_a \geq L_{cable} + L_i$$

The sum of capacitance and inductance of cable and intrinsic safe equipment must be less or equal to  $C_a$  and  $L_a$

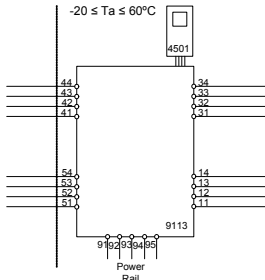

(terminal 11,12,13,14)  
(terminal 31,32,33,34)  
(terminal 91,92,93,94,95)  
 $U_m$ : 253 V, max 400 Hz

LERBAKKEN 10, 8410 RØNDE DENMARK

**Ex input**
**CH1 (terminal 41,42,43,44)**
**CH2 (terminal 51,52,53,54)**

 Vt (U<sub>o</sub>): 8.7 V

 It (I<sub>o</sub>): 18.4 mA

 P<sub>o</sub>: 40 mW

 L<sub>o</sub>/R<sub>o</sub> 892 μH/Ω

	II C / Group A,B	II B / Group C,E,F	II A / Group D,G
C <sub>g</sub> / C <sub>o</sub>	5 μF	50 μF	1000 μF
L <sub>g</sub> / L <sub>o</sub>	100 mH	300 mH	700 mH

 U<sub>i</sub>: 10 V

 I<sub>i</sub>: 30 mA

 C<sub>i</sub>: 30 nF

 L<sub>i</sub>: 820 nH

**Status Relay. terminal (33,34)**

Voltage max: 125 VAC / 110 VDC

Power max: 62.5 VA / 32 W

Current max: 0.5 A AC / 0.3 ADC

Zone 2 installation:

Voltage max: 32 VAC / 32 VDC

Power max: 16 VA / 32 W

Current max: 0.5 A AC / 1 ADC

**Installation notes:**

The installation and wiring shall be in accordance with the National Electrical Code NFPA 70, Article 500 or 505.

The module must be supplied from a Power Supply having double or reinforced insulation.

The use of stranded wires is not permitted for mains wiring except when wires are fitted with cable ends.

For installation on the 9400 Power Rail the power must be supplied from Power Control Module Unit 9410.

For installation in Zone 2 or Division 2, the module must be installed in a suitable outer enclosure having an IP protection of at least IP54.

The module is galvanically isolated and does not require grounding.

Install in pollution degree 2 or better.

Use 60 / 75 °C Copper Conductors with wire size AWG: (26-14).

**Warning:** Substitution of components may impair intrinsic safety.

**Warning:** To prevent ignition of the explosive atmospheres, disconnect power before servicing and do not separate connectors when energized and an explosive gas mixture is present.

**Warning:** Do not mount or remove modules from the Power Rail when an explosive gas mixture is present.

**Hazardous area**

 Class I/II/III, Division 1, Group A,B,C,D,E,F,G  
 or Class I, Zone 0/1 Group IIC

**Non Hazardous Area or**

 Class I, Division 2, Group A,B,C,D T4  
 or Class I, Zone 2 Group IIC T4

 Intrinsically safe apparatus  
 entity parameters:

$$V_{max}(U_i) \geq V_t(U_o)$$

$$I_{max}(I_i) \geq I_t(I_o)$$

$$P_i \geq P_o$$

$$C_a \geq C_{cable} + C_i$$

$$L_a \geq L_{cable} + L_i$$

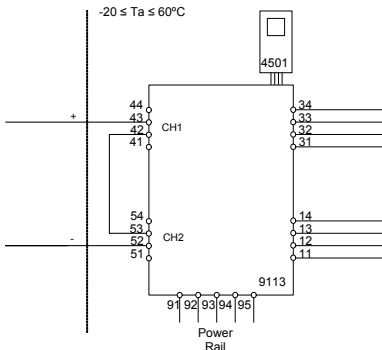
 The sum of capacitance and  
 inductance of cable and  
 intrinsic safe equipment must  
 be less or equal to  $C_a$  and  $L_a$ 

**Ex input**
**CH1 (terminal 42,43)**
**CH2 (terminal 52,53)**
 $V_t(U_o): 17.4\text{ V}$ 
 $I_t(I_o): 18.4\text{ mA}$ 
 $P_o: 80\text{ mW}$ 
 $L_o/R_o: 445\text{ }\mu\text{H}/\Omega$ 
**(terminal 11,12,13,14)**
**(terminal 31,32,33,34)**
**(terminal 91,92,93,94,95)**
 $U_m: 253\text{ V, max. } 400\text{ Hz}$ 

	IIC / Group A,B	IIB / Group C,E,F	IIA / Group D,G
$C_a / C_o$	0.3 $\mu\text{F}$	1.6 $\mu\text{F}$	8 $\mu\text{F}$
$L_a / L_o$	80 mH	250 mH	600 mH

 $U_i: 10\text{ V}$   
 $I_i: 30\text{ mA}$   
 $C_i: 15\text{ nF}$   
 $L_i: 1.7\text{ }\mu\text{H}$

# **SAFETY MANUAL**

## **TEMPERATURE / mA CONVERTER 9113**

**This safety manual is valid for the following product versions:  
9113-002**

**0 CONTENTS**

1	Observed standards.....	3
2	Acronyms and abbreviations .....	3
3	Purpose of the product.....	3
4	Assumptions and restrictions for use of the product .....	4
4.1	Basic safety specifications .....	4
4.2	Safety accuracy .....	4
4.2.1	Minimum span .....	4
4.2.2	Range limitations .....	4
4.3	Associated equipment.....	4
4.3.1	RTD sensor wiring .....	4
4.3.2	Sensor errors .....	5
4.3.3	Process calibration .....	5
4.3.4	Analogue output .....	5
4.4	Failure rates .....	5
4.5	Safe parameterisation.....	5
4.6	Installation in hazardous areas .....	5
5	Functional specification of the safety function .....	5
6	Functional specification of the non-safety functions.....	5
7	Safety parameters .....	6
8	Hardware and software configuration.....	6
9	Failure category.....	6
10	Periodic proof test procedure .....	7
11	Procedures to repair or replace the product.....	7
12	Maintenance.....	7
13	Documentation for routing diagram.....	7
13.1	In general .....	7
13.2	Further explanations .....	8
13.2.1	Password protection.....	8
13.2.2	Sensor/cable fault information via display front 4501 .....	8
13.3	Advanced functions.....	8
13.3.1	Memory (MEM) .....	8
13.3.2	Display setup (DISP) .....	8
13.3.3	Password (PASS) .....	8
13.3.4	Language (LANG).....	8
13.3.5	Process calibration (CAL) .....	9
13.3.6	Power rail (RAIL) .....	9
13.3.7	Simulation (SIM).....	9
13.3.8	Safety integrity level (SIL) .....	9
14	Safe parameterisation - user responsibility .....	10
14.1	Safety-related configuration parameters.....	10
14.1.1	Parameters related only to Channel 1 .....	10
14.1.2	Parameters related only to Channel 2 (only for type 9113BB) .....	13
14.1.3	Parameters related to both channels .....	13
14.2	Verification procedure.....	13
14.2.1	If no password is set .....	14
14.2.2	If password is set.....	17
14.2.3	If any parameter is found to be incorrect during verification .....	17
14.3	Functional test.....	17

15	Fault reaction and restart condition.....	17
16	User interface.....	18
16.1	Scrolling help texts in display line 3 .....	18
16.2	Routing diagram .....	19
16.3	Routing diagram - Advanced settings (ADV.SET).....	21
17	Connections diagram.....	22

## 1 Observed standards

Standard	Description
IEC 61508	Functional Safety of electrical / electronic / programmable electronic safety-related systems
IEC 61508-2:2000	Part 2: Requirements for electrical / electronic / programmable electronic safety-related systems
IEC 61508-3:1998	Part 3: Software requirements
IEC 61326-3-1:2008	Immunity requirements for safety-related systems

## 2 Acronyms and abbreviations

Acronym / Abbreviation	Designation	Description
Element		Term defined by IEC 61508 as "part of a subsystem comprising a single component or any group of components that performs one or more element safety functions"
PFD	Probability of Failure on Demand	This is the likelihood of dangerous safety function failures occurring on demand.
PFH	Probability of dangerous Failure per Hour	The term "Probability" is misleading, as IEC 61508 defines a Rate.
SFF	Safe Failure Fraction	Safe Failure Fraction summarises the fraction of failures which lead to a safe state and the fraction of failures which will be detected by diagnostic measures and lead to a defined safety action.
SIF	Safety Integrity Function	Function that provides fault detection (to ensure the necessary safety integrity for the safety functions)
SIL	Safety Integrity Level	The international standard IEC 61508 specifies four discrete safety integrity levels (SIL 1 to SIL 4). Each level corresponds to a specific probability range regarding the failure of a safety function.

## 3 Purpose of the product

Conversion and scaling of temperature (Pt, Ni and TC) and current signals from hazardous area.

The device can be mounted in the safe area and in zone 2 / div. 2 and receive signals from zone 0, 1, 2, 20, 21 and 22 / Class I/II/III, Div. 1, Gr. A-G.

Error events, including cable breakage, are monitored and signalled via the individual status relay and/or a collective electronic signal via the power rail.

The 9113 has been designed, developed and certified for use in SIL 2 applications according to the requirements of IEC 61508.

## 4 Assumptions and restrictions for use of the product

### 4.1 Basic safety specifications

Operational temperature range.....	-20...+60°C
Storage temperature range.....	-20...+85°C
Power supply type, min.....	Double or reinforced
Supply voltage.....	19.2...31.2 VDC
External loop supply voltage.....	5...26 VDC + external drop
Mounting area.....	Zone 2 / Division 2 or safe area
Mounting environment.....	Pollution degree 2 or better

### 4.2 Safety accuracy

The analogue output corresponds to the applied input within the safety accuracy.  
 Safety accuracy..... ±2%

#### 4.2.1 Minimum span

For temperature measurements, the selected range (OUT.HI - OUT.LO) shall be larger or equal to the values below:

Input type	Minimum span for safety accuracy
Pt100, Pt200, Pt1000	28°C
Pt500, Ni100, Ni120, Ni1000	43°C
Pt50, Pt400, Ni50	57°C
Pt250, Pt300	85°C
Pt20	142°C
Pt10	283°C
TC: E, J, K, L, N, T, U	91°C
TC: B, R, S, W3, W5, LR	153°C

#### 4.2.2 Range limitations

TC type B shall not be used below +400°C

### 4.3 Associated equipment

#### 4.3.1 RTD sensor wiring

If a 2-wire or a 3-wire connection for RTD is selected, the end user must ensure that the applied sensor wiring does not introduce failures exceeding the requirements for the safety application.

#### 4.3.2 Sensor errors

If Sensor error detection is disabled, if current input range 0...20 mA is selected or if input type Pt10, Pt20, or Pt50 is selected, the end user must ensure that the applied sensor including wiring has a failure rate qualifying it for the safety application without sensor error detection enabled.

For Pt10, Pt20 and Pt50 input types, this only relates to short-circuited sensor detection.

#### 4.3.3 Process calibration

If a process calibration is taken into SIL-mode operation, it is mandatory that the accuracy of the device (and sensor, if applicable) are tested by the end user after SIL-mode is entered, in addition to the normal functional test. Refer to section 14 - Safe parameterisation - user responsibility.

#### 4.3.4 Analogue output

The connected safety PLC shall be able to detect and handle the fault indications on the analogue output of the 9113 converter by having a NAMUR NE43-compliant current input.

#### 4.4 Failure rates

The basic failure rates from the Siemens standard SN 29500 are used as the failure rate database.

Failure rates are constant, wear-out mechanisms are not included.

External power supply failure rates are not included.

#### 4.5 Safe parameterisation

The user is responsible for verifying the correctness of the configuration parameters. (See section 14 Safe parameterisation - user responsibility).

Manual override may not be used for safety applications.

#### 4.6 Installation in hazardous areas

The IECEx Installation drawing, ATEX Installation drawing and FM Installation drawing shall be followed if the products are installed in hazardous areas.

### 5 Functional specification of the safety function

Conversion of current signals (0...20 mA or 4...20 mA), RTD sensor signals or thermocouple sensor signals from hazardous areas to a 4...20 mA current output signal, in two separately configurable channels, within specified accuracy.

For RTD sensors, cable resistances of up to 50  $\Omega$  per wire can be compensated if 3- or 4-wire connection is configured.

For thermocouple sensors, cold junction temperature errors can be compensated, either by an internally mounted temperature sensor, or by an accessory connector with a built-in temperature sensor. The selection of CJC measurement must be done and verified by the end user.

### 6 Functional specification of the non-safety functions

The status relay (terminal 33 and 34), error signal on power rail (terminal 91) and LED outputs are not suitable for use in any Safety Instrumented Function.

## 7 Safety parameters

Probability of dangerous Failure per Hour (PFH)	6.10E-08
	Note <sup>1</sup>
Probability of failure on demand (PFD) - 1 year proof test interval	3.96E-04
Proof test interval (10% of loop PFD)	3 years
Safe Failure Fraction	90.7 %
Demand response time	Signal input: < 0.5 seconds Temperature input: < 1.1 seconds
Demand mode	High
Demand rate	3000 seconds
Mean Time To Repair (MTTR)	24 hours
Diagnostic test interval	30 seconds
Hardware Fault Tolerance (HFT)	0
Component Type	B
SIL capability	SIL 2
Description of the "Safe State"	Output $\leq$ 3.6 mA or output $\geq$ 21 mA

Note1: The 9113 contains no lifetime limiting components, therefore the PFH figures are valid for up to 12 years, according to IEC 61508.

## 8 Hardware and software configuration

All configurations of software and hardware versions are fixed from factory, and cannot be changed by end-user or reseller.

This manual only covers products labelled with the product version (or range of versions) specified on the front page.

## 9 Failure category

Failure category	Failure rates (1/h)
Fail Safe Detected	0.000E-0
Fail Safe Undetected	2.34E-7
Fail Dangerous Detected	3.67E-7
Fail Dangerous Undetected	6.10E-8

## 10 Periodic proof test procedure

Step	Action
1	Bypass the safety PLC or take other appropriate action to avoid a false trip
2	Connect a simulator identical to the input setup
3	Apply input value corresponding to 0/100% output range to each channel
4	Observe whether the output channel acts as expected
5	Restore the input terminals to full operation
6	Remove the bypass from the safety PLC or otherwise restore normal operation

This test will detect approximately 95% of possible “du” (dangerous undetected) failures in the device. The proof test is equivalent to the functional test.

## 11 Procedures to repair or replace the product

Any failures that are detected and that compromise functional safety should be reported to the sales department at PR electronics A/S.

Repair of the device and replacement of circuit breakers must be done by PR electronics A/S only.

## 12 Maintenance

No maintenance required.

## 13 Documentation for routing diagram

The routing diagram is shown in section 16.2.

### 13.1 In general

When configuring the 9113, you will be guided through all parameters and you can choose the settings which fit the application. For each menu there is a scrolling help text which is automatically shown in line 3 on the display.

Configuration is carried out by use of the 3 function keys:

- ⏪ will increase the numerical value or choose the next parameter
- ⏩ will decrease the numerical value or choose the previous parameter
- ⏹ will accept the chosen value and proceed to the next menu

When configuration is completed, the display will return to the default state 1.0.

Pressing and holding ⏹ will return to the previous menu or return to the default state (1.0) without saving the changed values or parameters.

If no key is activated for 1 minute, the display will return to the default state (1.0) without saving the changed values or parameters.

### 13.2 Further explanations

#### 13.2.1 Password protection

Access to the configuration can be blocked by assigning a password. The password is saved in the device in order to ensure a high degree of protection against unauthorised modifications to the configuration. Default password 2008 allows access to all configuration menus. Password protection is mandatory in SIL applications.

#### 13.2.2 Sensor/cable fault information via display front 4501

When the function is enabled and supported by selected input type, sensor or cable faults are displayed as SE.BR (sensor break) or SE.SH (cable short-circuited). Sensor fault is shown independently for each channel.

In case of sensor or cable fault the backlight flashes. This can be reset by pressing the  key. When the sensor or cable fault has been remedied, the device will return to normal operation.

### 13.3 Advanced functions

The device gives access to a number of advanced functions which can be reached by answering "Yes" to the point "adv.set".

#### 13.3.1 Memory (MEM)

In the memory menu a non-SIL configuration can be either saved or loaded from the local memory of the 4501 display unit. Choose SAVE to store the current configuration in the 4501 memory. Press LOAD to read a previously stored configuration in the 4501 memory and store it in the device. It is only possible to load a configuration stored from the same type of device and from the same version, or earlier.

#### 13.3.2 Display setup (DISP)

The brightness contrast and the backlight can be adjusted.

Tag numbers with 5 alphanumeric can be entered for both channels.

Functional readout in line 2 (ch.1) and 3 (Ch.2) of the display can be selected: choose between readout of input value, output current or tag no. When selecting "ALT" the readout alternates between input value, output current and tag no.

#### 13.3.3 Password (PASS)

Here you can choose a password between 0000 and 9999 in order to protect the device against unauthorised modifications to the configuration. The device is delivered default without password.

#### 13.3.4 Language (LANG)

In this menu you can choose between 7 different language versions of help texts that will appear in the menu. You can choose between UK, DE, FR, IT, ES, SE and DK.

**13.3.5 Process calibration (CAL)**

A process calibration can be made by the end user. A known process signal must be applied for both low and high end of the input measurement range. The known input of the applied low end signal must be entered in the CAL.LO menu and confirmed by pressing OK before removing or changing the applied signal to the high end signal. The known input of the applied high end signal must be entered in the CAL.HI menu and confirmed by pressing OK before removing. It is possible to enable or disable the use of the latest process calibration.

**13.3.6 Power rail (RAIL)**

In this menu it can be chosen if errors in the device are transmitted to the central surveillance in the PR 9410 power control device.

**13.3.7 Simulation (SIM)**

It is possible to override the actual measured input signal by a simulated value. Only one channel can be simulated at a time. Leaving either of the simulation menus, or disconnecting the 4501 device, will disable the simulation mode and bring the output back to correspond to the actual measured value. Simulation is not possible in SIL-mode.

**13.3.8 Safety integrity level (SIL)**

See section 14 - Safe parameterisation - user responsibility

**14 Safe parameterisation - user responsibility****14.1 Safety-related configuration parameters****14.1.1 Parameters related only to Channel 1**

Name	Function
CH1.TYP	Selected input type: TEMP = Temperature CURR = Current
I.RANGE	Selected fixed input range for current measurements (for CH1.TYP = CURR): 0_20 = 0...20 mA (no sensor error detection!) 4_20 = 4...20 mA
CONNEX	Selected sensor connection type for RTD measurements (for SENSOR = Ni or Pt): 2W = 2-wire 3W = 3-wire 4W = 4-wire If 2W or 3W is selected, the end user must ensure that the applied sensor wiring does not introduce failures exceeding the requirements for the safety application.
UNIT	Selected temperature unit (for CH1.TYP = TEMP): °C = degrees Celsius °F = degrees Fahrenheit
SENSOR	Selected temperature sensor type (for CH1.TYP = TEMP): TC = Thermocouple Ni = Ni RTD sensor Pt = Pt RTD sensor
Pt.TYPE	Pt sensor type (for SENSOR = Pt): 10 = Pt10 20 = Pt20 50 = Pt50 100 = Pt100 200 = Pt200 250 = Pt250 300 = Pt300 400 = Pt400 500 = Pt500 1000 = Pt1000 (No short circuit detection!)

Name	Function
Ni.TYPE	Ni sensor type (for SENSOR = Ni): 50 = Ni50 100 = Ni100 120 = Ni120 1000 = Ni1000
TC.TYPE	Thermocouple type (for SENSOR = TC): TC.B = Thermocouple type B TC.E = Thermocouple type E TC.J = Thermocouple type J TC.K = Thermocouple type K TC.L = Thermocouple type L TC.N = Thermocouple type N TC.R = Thermocouple type R TC.S = Thermocouple type S TC.T = Thermocouple type T TC.U = Thermocouple type U TC.W3 = Thermocouple type W3 TC.W5 = Thermocouple type W5 TC.Lr = Thermocouple type Lr
CJC	CJC type for SENSOR = TC: INT = Internal CJC sensor measurement CONN = CJC connector measurement (accessory)
O.RANGE	Fixed output range for current output: 0-20 = 0...20 mA Not valid when EN.SIL = YES (Safety applications) 4-20 = 4...20 mA 20-0 = 20...0 mA Not valid when EN.SIL = YES (Safety applications) 20-4 = 20...4 mA

Name	Function
OUT.ERR	<p>Fixed output value on detected sensor error:            NONE = Sensor error detection NOT enabled, output at sensor error is undefined.</p> <p>The end user must ensure that the applied sensor including wiring has a failure rate qualifying it for the safety application without the detection enabled.</p> <p>0 mA = Output is 0 mA at sensor error            3.5 mA = Output is 3.5 mA at sensor error (NE43 downscale)            23 mA = Output is 23 mA at sensor error (NE4 upscale)</p>
OUT.LO	<p>Selected temperature value for 0% output for CH1.TYP = TEMP in units defined by the UNIT parameter (°C or °F)</p> <p>Range is defined by the selected temperature sensor (SENSOR and TC.TYPE, Ni.TYPE or Pt.TYPE), but value must be less than OUT.HI - minimum span.</p>
OUT.HI	<p>Selected temperature value for 100% output for CH1.TYP = TEMP in units defined by the UNIT parameter (°C or °F).</p> <p>Range is defined by the selected temperature sensor (SENSOR and TC.TYPE, Ni.TYPE or Pt.TYPE), but must be larger than OUT.LO + minimum span.</p>
RESP	<p>Analogue output response time in seconds.</p> <p>Range is 0.0 to 60.0 seconds.</p>
USE.CAL	<p>Use the applied process calibration values:</p> <p>NO = The last performed process calibration on Channel1 is not used. The channel operates with accuracy as specified.</p> <p>YES = The last performed process calibration on Channel1 is in operation. The required accuracy must be verified by user.</p> <p>End user must verify by test that the applied process calibration does not introduce failures exceeding the requirements for the safety application.</p>

**14.1.2 Parameters related only to Channel 2 (only for type 9113BB)**

Name	Function
CH1.TYP	Functions as described for Channel 1 (14.1.1)
I.RANGE	
CONNEX	
UNIT	
SENSOR	
Pt.TYPE	
Ni.TYPE	
TC.TYPE	
CJC	
O.RANGE	
OUT.ERR	
OUT.LO	
OUT.HI	
RESP	
USE.CAL	

**14.1.3. Parameters related to both channels**

Name	Function
NEW.PAS	Password for protection of the device configuration from un-authorized access. Range from 0 to 9999.

The above safety-related configuration parameters are marked in red text in the routing diagrams and must be verified by the user in a SIL configuration.

**14.2. Verification procedure**

The verification is done using the display / programming front PR 4501 and following the procedure described below.

**14.2.1 If no password is set**

	<b>Action</b>	<b>Display shows</b>
1	Press OK	ADV.SET
2	Set (ADV.SET) to Yes and press OK	SETUP
3	Set SETUP to SIL and press OK	EN.SIL
4	Set EN.SIL to YES and press OK	NEW.PAS
5	Set password to a number between 0 and 9999 and press OK (At this time the device starts operating in SIL mode with the entered configuration parameters!)	CONFIG Verify OPEN->LOCK*
6	Press OK to confirm verification of the OPEN->LOCK in the display	CH1.TYP
7	Verify input type for Channel 1 and press OK	I.RANGE
8	Verify fixed input range and press OK (ONLY IF CH1.TYP = CURR)	CONNEC
9	Verify sensor connection type and press OK (ONLY IF SENSOR = Ni or Pt and CH1.TYP = TEMP)	UNIT
10	Verify temperature unit and press OK (ONLY IF CH1.TYP = TEMP)	SENSOR
11	Verify temperature sensor type and press OK ( ONLY IF CH1.TYP = TEMP)	Pt.TYPE
12	Verify Pt sensor type and press OK (ONLY IF SENSOR = Pt and CH1.TYP = TEMP)	Ni.TYPE
13	Verify Ni sensor type and press OK (ONLY IF SENSOR = Ni and CH1.TYP = TEMP)	TC.TYPE
14	Verify Thermocouple type and press OK (ONLY IF SENSOR = TC and CH1.TYP = TEMP)	CJC

\* Open is shown briefly in the display.

	Action	Display shows
15	Verify CJC type and press OK (ONLY IF SENSOR = TC and CH1.TYP = TEMP)	O.RANGE
16	Verify fixed output range and press OK	OUT.ERR
17	Verify fixed output value on detected sensor error and press OK (ONLY IF CH1.TYP = TEMP, or IF I.RANGE = 4-20 mA)	OUT.LO
18	Verify temperature for 0% output and press OK (ONLY IF CH1.TYP = TEMP)	OUT.HI
19	Verify temperature for 100% output and press OK (ONLY IF CH1.TYP = TEMP)	RESP
20	Verify analogue output response time and press OK	CH2.TYP
21	Verify input type for Channel 2 and press OK	I.RANGE
22	Verify fixed input range and press OK (ONLY IF CH2.TYP = CURR)	CONNEC
23	Verify sensor connection type and press OK (ONLY IF SENSOR = Ni or Pt and CH2.TYP = TEMP)	UNIT
24	Verify temperature unit and press OK (ONLY IF CH2.TYP = TEMP)	SENSOR
25	Verify temperature sensor type and press OK ( ONLY IF CH2.TYP = TEMP)	Pt.TYPE
26	Verify Pt sensor type and press OK (ONLY IF SENSOR = Pt and CH2.TYP = TEMP)	Ni.TYPE

	Action	Display shows
27	Verify Ni sensor type and press OK (ONLY IF SENSOR = Ni and CH2.TYP = TEMP)	TC.TYPE
28	Verify Thermocouple type and press OK (ONLY IF SENSOR = TC and CH2.TYP = TEMP)	CJC
29	Verify CJC type and press OK (ONLY IF SENSOR = TC and CH2.TYP = TEMP)	O.RANGE
30	Verify fixed output range for current output	OUT.ERR
31	Verify fixed output value on detected sensor error and press OK (ONLY IF CH2.TYP = TEMP, or IF I.RANGE = 4-20 mA or 20-4 mA)	OUT.LO
32	Verify temperature for 0% output and press OK (ONLY IF CH2.TYP = TEMP)	OUT.HI
33	Verify temperature for 100% output and press OK (ONLY IF CH2.TYP = TEMP)	RESP
34	Verify analogue output response time and press OK	CH1.CAL
35	Verify the use of applied process calibration values for Channel 1 and press OK	CH2.CAL
36	Verify the use of applied process calibration values for Channel 2 and press OK	PASSW.
37	Verify password and press OK	SIL.OK
38	Verify SIL mode within 1 second	

**14.2.2 If password is set**

	<b>Action</b>	<b>Display shows</b>
1	Press OK	PASSW
2	Enter password and press OK	ADV.SET
3	Set ADV.SET to Yes and press OK	SETUP
4	Set SETUP to SIL and press OK	EN.SIL
5	Set EN.SIL to YES and press OK (At this time the device starts operating in SIL mode with the entered configuration parameters!)	CONFIG Verify OPEN->LOCK*
6 to 38	As step 6 to 38 for 14.2.1	As step 6 to 38 for 14.2.1

\* Open is shown briefly in the display

**14.2.3 If any parameter is found to be incorrect during verification**

Remove SIL-mode (by entering the password and selecting SIL-mode OFF).

Go through the setup menu and correct the parameter(s).

Repeat step 1 to 38 (with correct parameters).

**14.3 Functional test**

The user is responsible to make a functional test after verification of the safety parameters. The procedure for periodic proof test described in section 10 shall be used.

In addition, if a process calibration is taken into SIL-mode operation (refer to section 13.3 - Advanced functions), it is mandatory that the accuracy of the device (and sensor, if applicable) are tested.

**15 Fault reaction and restart condition**

When the 9113 detects a fault the output will go to Safe State, in which the output will go to "de-energised".

If the fault is application-specific (cable error detection) the 9113 will restart when the fault has been corrected.

For device faults there are 2 ways of bringing the device out of Safe State.

1. Power cycle the device.
2. Bring the device out of SIL mode (choose "NO" in the menu point "EN.SIL"), and set it back to SIL mode again (choose "YES" in the menu point "EN.SIL" and verify the configuration).

## 16 User interface

### 16.1 Scrolling help texts in display line 3

- |      |  |      |   |
|------|--|------|---|
| [01] | Set correct password                               | [17] | Enter SIL setup   |
| [02] | Enter advanced setup menu?                         |      | Enter simulation mode                                     |
| [03] | Select temperature input                           |      | Enter RAIL setup  |
|      | Select current input                               |      | Perform process calibration                               |
| [04] | Select 0-20 mA input range                         |      | Enter language setup                                      |
|      | Select 4-20 mA input range                         |      | Enter password setup                                      |
| [05] | Select TC sensor type                              |      | Enter display setup                                       |
|      | Select Ni sensor type                              |      | Perform memory operations                                 |
|      | Select Pt sensor type                              | [18] | Load saved configuration into 9113                        |
| [06] | Select Pt10 sensor type                            |      | Save 9113 configuration in 4501                           |
|      | Select Pt20 sensor type                            | [19] | Adjust LCD contrast                                       |
|      | Select Pt50 sensor type                            | [20] | Adjust LCD backlight                                      |
|      | Select Pt100 sensor type                           | [21] | Write a 5-character channel TAG                           |
|      | Select Pt200 sensor type                           | [22] | Show analogue input value in display                      |
|      | Select Pt250 sensor type                           |      | Show analogue output value in display                     |
|      | Select Pt300 sensor type                           |      | Show TAG in display                                       |
|      | Select Pt400 sensor type                           |      | Alternate shown information in display                    |
|      | Select Pt500 sensor type                           | [23] | Enable password protection?                               |
|      | Select Pt1000 sensor type                          | [24] | Set new password  |
| [07] | Select Ni50 sensor type                            | [25] | Select language   |
|      | Select Ni100 sensor type                           | [26] | Select channel to calibrate                               |
|      | Select Ni120 sensor type                           | [27] | Calibrate input low to process value?                     |
|      | Select Ni1000 sensor type                          | [28] | Set value for low calibration point                       |
| [08] | Select TC-B sensor type                            | [29] | Calibrate input high to process value?                    |
|      | Select TC-E sensor type                            | [30] | Set value for high calibration point                      |
|      | Select TC-J sensor type                            | [31] | Use process calibration values?                           |
|      | Select TC-K sensor type                            | [32] | Select channel to simulate                                |
|      | Select TC-L sensor type                            | [33] | Set the input simulation value                            |
|      | Select TC-N sensor type                            | [34] | Enable SIL configuration lock?                            |
|      | Select TC-R sensor type                            |      | 0-20 mA is not a valid output range for SIL operation     |
|      | Select TC-S sensor type                            | [35] | Set Analog output response time in seconds                |
|      | Select TC-T sensor type                            | [36] | Select internal temperature sensor                        |
|      | Select TC-U sensor type                            |      | Select CJC connector (accessory)                          |
|      | Select TC-W3 sensor type                           | [37] | ...is channel using process-compensated calibration data? |
|      | Select TC-W5 sensor type                           | [38] | Configuration SIL status (Open / Locked)                  |
|      | Select TC-Lr sensor type                           | [40] | Sensor wire breakage                                      |
| [09] | Select 2-wire sensor connection                    | [41] | Sensor short circuit                                      |
|      | Select 3-wire sensor connection                    | [42] | Input underrange  |
|      | Select 4-wire sensor connection                    | [43] | Input overrange   |
| [11] | Select Celsius as temperature unit                 | [44] | Input error - check input connections and reset power     |
|      | Select Fahrenheit as temperature unit              | [45] | Output error - check connections and reset power          |
| [12] | Select 0-20 mA output range                        | [46] | Flash memory error - check configuration                  |
|      | Select 4-20 mA output range                        | [47] | Invalid configuration type or version                     |
|      | Select 20-0 mA output range                        | [48] | Hardware error  |
|      | Select 20-4 mA output range                        | [49] | CJC sensor error - check device temperature               |
| [13] | Select no error action - output undefined at error | [50] | CJC error - check CJC connector block                     |
|      | Select downscale at error                          | [51] | No communication  |
|      | Select NAMUR NE43 downscale at error               |      |   |
|      | Select NAMUR NE43 upscale at error                 |      |   |
| [14] | Set temperature for analogue output low            |      |   |
| [15] | Set temperature for analogue output high           |      |   |
| [16] | Enable Rail status signal output?                  |      |   |



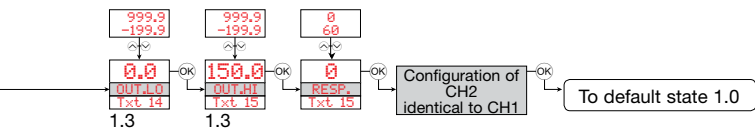

### 16.3 Routing diagram - Advanced settings (ADV.SET)

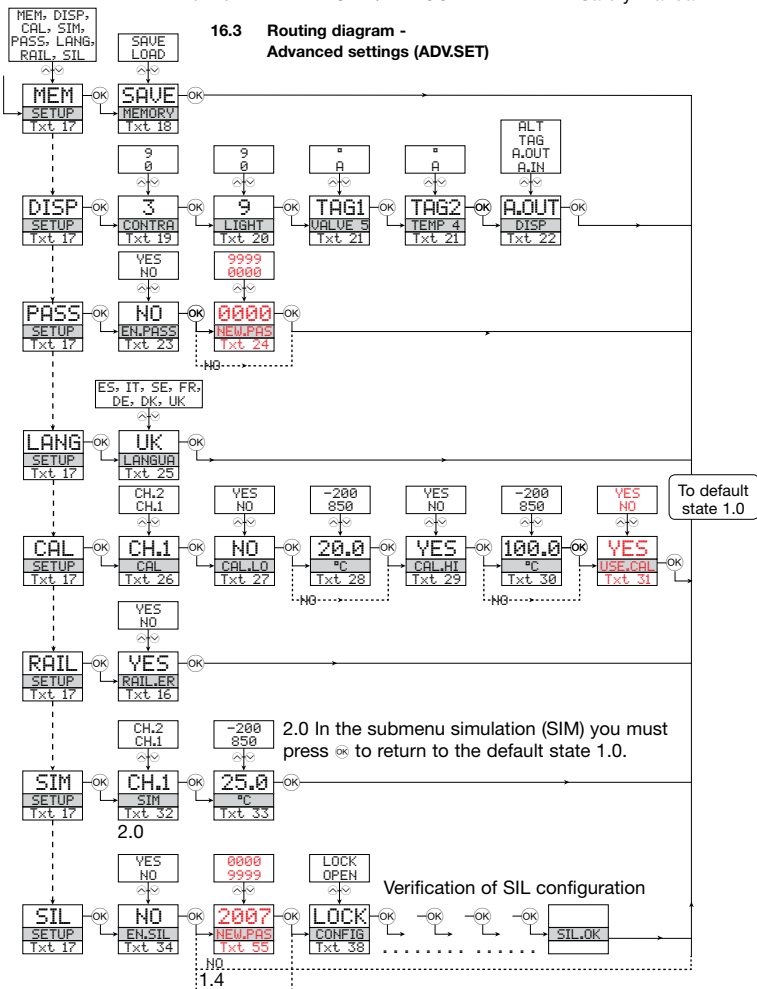

## 17 Connections diagram

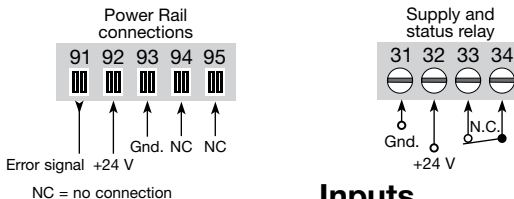

## Inputs

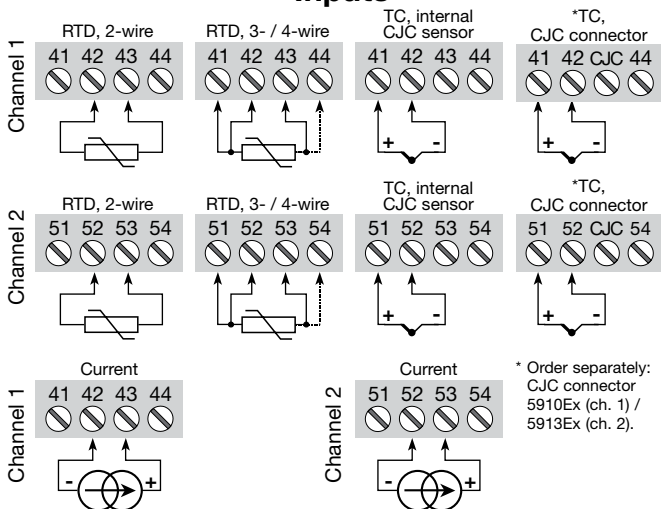

## Outputs

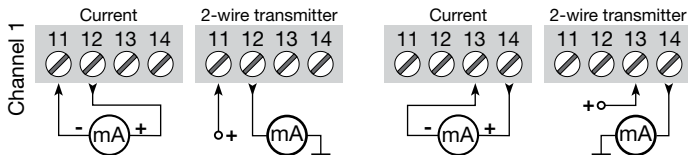



**Displays** Programmable displays with a wide selection of inputs and outputs for display of temperature, volume and weight, etc. Feature linearisation, scaling, and difference measurement functions for programming via PReset software.



**Ex interfaces** Interfaces for analogue and digital signals as well as HART® signals between sensors / I/P converters / frequency signals and control systems in Ex zone 0, 1 & 2 and for some devices in zone 20, 21 & 22.



**Isolation** Galvanic isolators for analogue and digital signals as well as HART® signals. A wide product range with both loop-powered and universal isolators featuring linearisation, inversion, and scaling of output signals.



**Temperature** A wide selection of transmitters for DIN form B mounting and DIN rail devices with analogue and digital bus communication ranging from application-specific to universal transmitters.



**Universal** PC or front programmable devices with universal options for input, output and supply. This range offers a number of advanced features such as process calibration, linearisation and auto-diagnosis.



## Subsidiaries

### France

PR electronics Sarl  
Zac du Chêne, Activillage sales@preelectronics.fr  
4, allée des Sorbiers tel. +33 (0) 4 72 14 06 07  
F-69673 Bron Cedex fax +33 (0) 4 72 37 88 20

### Germany

PR electronics GmbH sales@preelectronics.de  
Im Erlengrund 26 tel. +49 (0) 208 62 53 09-0  
D-46149 Oberhausen fax +49 (0) 208 62 53 09-99

### Italy

PR electronics S.r.l. sales@preelectronics.it  
Via Giuliotti, 8 tel. +39 02 2630 6259  
IT-20132 Milano fax +39 02 2630 6283

### Spain

PR electronics S.L. sales@preelectronics.es  
Avda. Meridiana 354, 9<sup>a</sup> B tel. +34 93 311 01 67  
E-08027 Barcelona fax +34 93 311 08 17

### Sweden

PR electronics AB sales@preelectronics.se  
August Barks gata 6A tel. +46 (0) 3149 9990  
S-421 32 Västra Frölunda fax +46 (0) 3149 1590

### UK

PR electronics UK Ltd sales@preelectronics.co.uk  
Middle Barn, Apuldram tel. +44 (0) 1243 776 450  
Chichester fax +44 (0) 1243 774 065  
West Sussex, PO20 7FD

### USA

PR electronics Inc sales@preelectronics.com  
11225 West Bernardo Court tel. +1 858 521 0167  
Suite A San Diego, California 92127 fax +1 858 521 0945

## Head office

Denmark www.preelectronics.com  
PR electronics A/S sales@preelectronics.dk  
Lerbakken 10 tel. +45 86 37 26 77  
DK-8410 Rønde fax +45 86 37 30 85

