



Configuration Manual

PROFIBUS® PA

5 3 5 0

PROFIBUS® PA / FOUNDATION™
Fieldbus Transmitter

No. 5350Q102(0420)
From ser. no. 030640001

Approvals



SIGNALS THE BEST

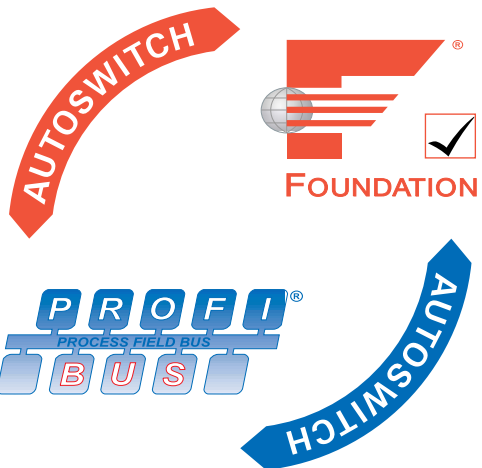

CONTENTS

Introduction	3
This configuration manual	3
The Fieldbus Software	3
Driver for Siemens PDM software	3
Parameter lists abbreviations	3
1.0 The Physical Block (PA Slot 0), Profibus	3
1.1 Diagnosis	3
1.2 Diagnosis of the Device Characteristics	3
1.3 Physical Block (PA Slot 0) Parameter List, Profibus	4
2.0 The Transducer Block	5
2.1 The Transducer Block	5
2.2 The data of the Transducer Block Parameter List are grouped as follows:	5
2.3 Default configuration	5
2.4 Your application set up.	5
2.5 AI_Transducer Block Configuration Flowchart	6
2.6 - Transducer Block Examples Setup	9
2.6.1 Measurement of RTD with one sensor:	9
2.6.2 Measurement of RTD with two sensors:	9
2.6.3 Measurement of thermocouple with one sensor:	9
2.6.4 Measurement of thermocouple with two sensors:	10
2.6.5 Measurement of combined sensors (Sensor 1 = TC and Sensor 2 = RTD):	10
2.6.6 Measurement of resistance (linear) with one sensor:	10
2.6.7 Measurement of resistance (linear) with two sensors:	11
2.6.8 Measurement of potentiometer (linear) with one sensor:	11
2.6.9 Measurement of potentiometer (linear) with two sensors:	11
2.6.10 Measurement of voltage (linear) with one sensor:	12
2.6.11 Measurement of voltage (linear) with two sensors:	12
2.6.12 Measurement of 2 potentiometers (with Linear interpolation linearisation):	12
2.6.13 Measurement of TC (with Custom Polynomial Linearisation) on sensor 1	13
2.7 AI_Transducer and PR_CUST_LIN Block, Schematic	14
2.8 AI_TRANSDUCER Block (PA Slot 3) Parameter List	15
2.8.1 Sensor characterising parameters	15
2.8.2 RTD / Resistor specific parameters	16
2.8.3 Thermocouple specific parameters	16
2.8.4 Output conditioning parameters	17
2.8.5 Output parameters	17
2.8.6 Diagnostic parameters	18
2.8.7 Sensor error detection parameters	18
2.8.8 Sensor calibration, Description	19
2.8.9 Sensor Calibration Parameters	19
2.9 PR_CUST_LIN Block (PA Slot 4) Parameter List	21
2.9.1 Linear interpolation linearisation, Description	21
2.9.2 Linear Interpolation Linearisation, Parameter List.	21
2.9.3 Custom polynomial linearisation, Description	22
2.9.4 Custom Polynomial Linearisation, Parameter List	23
2.10 PR_CUST_PRIV Block (PA Slot 5) Reserved Parameter List	23
2.10.1 Description, PR_CUST_PRIV Block	23
3.0 Analogue Input Blocks, Profibus	24
3.1 Analogue Input Blocks Overview, Profibus	24
3.2 Analogue Input Blocks (PA Slot 1 & 2) Parameter List, Profibus	25

Introduction

This configuration manual

contains the necessary information for configuration of the temperature transmitter PR5350 via a host system with application software for either Foundation™ Fieldbus or Profibus® PA. The autoswitch function of the modules ensures automatic switch to the connected protocol.

The Fieldbus Software

has been developed by PR electronics A/S according to the specifications of the Fieldbus Foundation and the PROFIBUS Nutzerorganisation.

The files for Profibus® PA are:

- PREL5350.gsd - Geräte Stamm Datei (Device Description Data)
- PR5350D.bmp - Icon for diagnostic mode
- PR5350N.bmp - Icon for normal mode
- PR5350S.bmp - Icon for special operation mode

PR electronics fieldbus transmitters are delivered with a CD that contains the files needed to configure the transmitters from a fieldbus host. These files can also be downloaded from our homepage www.prelectronics.com.

Please follow the instructions for the application software in question when installing the files.

Driver for Siemens PDM software

PR electronics has developed Device Description Language files for the Siemens PDM application software for Profibus® PA.

The files for Siemens PDM are:

- PREL5350.devices Installation file
- PREL5350.ddl Device Description file

These files can be delivered to interested customers at request.

Please follow the instructions for the Siemens PMD application software when installing the files.

Parameter lists abbreviations

In the Store column:

SRC = Static Revision Counter; N = No; D = Dynamic;
Cst = Constant. The parameter doesn't change in a device

In the RO / R/W column:

RO = Read Only; R /W = Read Write; * = Mixed of RO and R/W; ** = Don't care

1.0 The Physical Block (PA Slot 0), Profibus

1.1 Diagnosis

In order to provide some information about the device to the control application and the human interface, there are diagnosis parameters in the device. The diagnosis parameters have a bit string data type and there is a mask parameter indicating which diagnosis is supported by the device.

1.2 Diagnosis of the Device Characteristics

In the Physical block the DIAGNOSIS parameter has the information about the "alerts" into the device (for instance, device not initialized, power up, factory init, hardware failure, etc). The DIAGNOSIS_MASK has the diagnosis supported by the device.

1.3 Physical Block (PA Slot 0) Parameter List, Profibus

PARAMETER	Rel. Index	Description	Type	Store	Size	R/W	Min	Max	Default
ST_REV	1	Is incremented each time that there is a change in a static parameter in the physical block.	Un-signed 16	N	2	RO			0
TAG_DESC	2	Tag name of the block. This parameter must be unique in the configuration.	OCTET_STRING	SRC	32	R/W			' '
STRATEGY	3	This can be used to group a Function Block. It is a user supplied parameter for identification purpose.	Un-signed 16	SRC	2	R/W			0
ALERT_KEY	4	Current state of alarm blocks	Un-signed 8	SRC	1	R/W			0
TARGET_MODE	5	Current desired mode of the block.	Un-signed 8	SRC	1	R/W			-
MODE_BLK	6	A block has static block parameters, that are not changed by the process. Values are assigned to this parameter during the configuration or optimisation. The value of ST_REV must increase by 1 after every change of a static block parameter. This provides a check of the parameter revision.	DS-37	D	3	RO			Block specific
ALARM_SUM	7	Current state of the blocks alarms.	DS-42	D	8	RO			0,0,0,0
SOFTWARE_REVISION	8	Software revision of the device	VISBLE_STRING	Cst	16	RO			
HARDWARE_REVISION	9	Physical revision of the device.	VISBLE_STRING	Cst	16	RO			
DEVICE_MAN_ID	10	PR manufacturer identification number.	Un-signed 16	Cst	2	RO			0x006D
DEVICE_ID	11	Manufacturer device number	VISBLE_STRING	Cst	16	RO			»Pretop 5350 »
DEVICE_SER_NUM	12	Device serial number	VISBLE_STRING	Cst	16	RO			
DIAGNOSIS	13	Bit string indicating the diagnosis of the device. See Diagnosis	OCTET_STRING	D	4	RO			
DIAGNOSIS_EXTENSION	14	Not used.	OCTET_STRING	D	6	RO			
DIAGNOSIS_MASK	15	Not used.	OCTET_STRING	Cst	4	RO			
DIAGNOSIS_MASK_EXTENSION	16	Not used.	OCTET_STRING	Cst	6	RO			
DEVICE_CERTIFICATION	17	PA device certification	VISBLE_STRING	Cst	32	RO			
WRITE_LOCKING	18	If Locked, no writes from anywhere are allowed, except to clear WRITE_LOCK. Cyclic block inputs will continue to be updated.	Un-signed 16	N	2	R/W			
FACTORY_RESET	19	Factory reset: 1: Restart with default 2506: Restart processor 2712: Recover default address to the device	Un-signed 16	SRC	2	R/W			
DESCRIPTOR	20	It is a user supplied description of the block in the application.	OCTET_STRING	SRC	32	R/W			
DEVICE_MESSAGE	21	It is a user supplied Message of the block in the application..	OCTET_STRING	SRC	32	R/W			
DEVICE_INSTAL_DATE	22	Date of the device installation.	OCTET_STRING	SRC	16	R/W			
LOCAL_OP_ENA	23	Not Used.	Un-signed 8	N	1	R/W			1
IDENT_NUMBER_SELECT	24	0: Profile specific Ident_Num 1: Manufacture specific Ident_Number 2: Manufacture specific Ident_Number of V2.0 3: Ident_Number of Multi_Variable device	Un-signed 8	SRC	1	R/W			
HW_WRITE_PROTECTION	25	Unimplemented							
RESERVED	26-32	Reserved to PNO (PROFIBUS Nutzerorganisation)							

2.0 The Transducer Block

2.1 The Transducer Block

contains all of the manufacturer-specific parameters that define how the PR5350 Transmitter functions. Selections such as setting of input type, engineering units, defining the dual functionality when using the dual input, and so forth, are performed in the Transducer Block.

The transducer block in PR5350 allows the user to select a large number of sophisticated functions. Therefore, the configuration of the transmitter must be carried out with the greatest possible care.

2.2 The data of the Transducer Block Parameter List are grouped as follows:

2.8 AI_TRANSDUCER Block

- 2.8.1 Sensor characterising parameters
- 2.8.2 RTD / resistor specific parameters
- 2.8.3 Thermocouple specific parameters
- 2.8.4 Output conditioning parameters
- 2.8.5 Output parameters
- 2.8.6 Diagnostic parameters
- 2.8.7 Sensor error detection parameters
- 2.8.9 Sensor calibration parameters

2.9 PR_CUST_LIN Block

- 2.9.2 Linear Interpolation Linearisation
- 2.9.4 Custom Polynomial linearisation

2.10 PR_CUST_PRIV Block

- 2.10.1 PR_CUST_PRIV Block

All product-specific parameters are set off in grey background in the TB Parameter List. In order to configure these parameters, the files mentioned in the introduction must be available to the application software.

2.3 Default configuration

PR electronics delivers the transmitters with a default configuration which will suit the customer's demand in many cases. The configuration task has thus been reduced considerably. The individual default configurations are shown in the TB Parameter List, but in short the default configuration is as follows:

- Pt100 acc. to the standard EN 60 751 (2.8.1 LIN_TYPE, value 102)
- °C (2.8.1 PRIMARY_VALUE_UNIT, value 1001)
- 3-wire connection (2.8.2 SENSOR_CONNECTION, value 1)
- Only sensor 1 (2.8.4 SENSOR_MEAS_TYPE, value 220)
- No sensor error detection (2.8.7 SENSOR_WIRE_CHECK_1, value 3)

2.4 Your application set up.

In the Transducer block all parameters marked R / W can be adapted to suit any measurement in temperature, ohm or mV. The way of presenting the file data mentioned in the introduction varies greatly from one piece of application software to the other. Some programs show drop down menus in which the parameters must be selected via text lines, while other programs require the user to type in the numerical value of the parameter selection.

2.5 AI_Transducer Block Configuration Flowchart

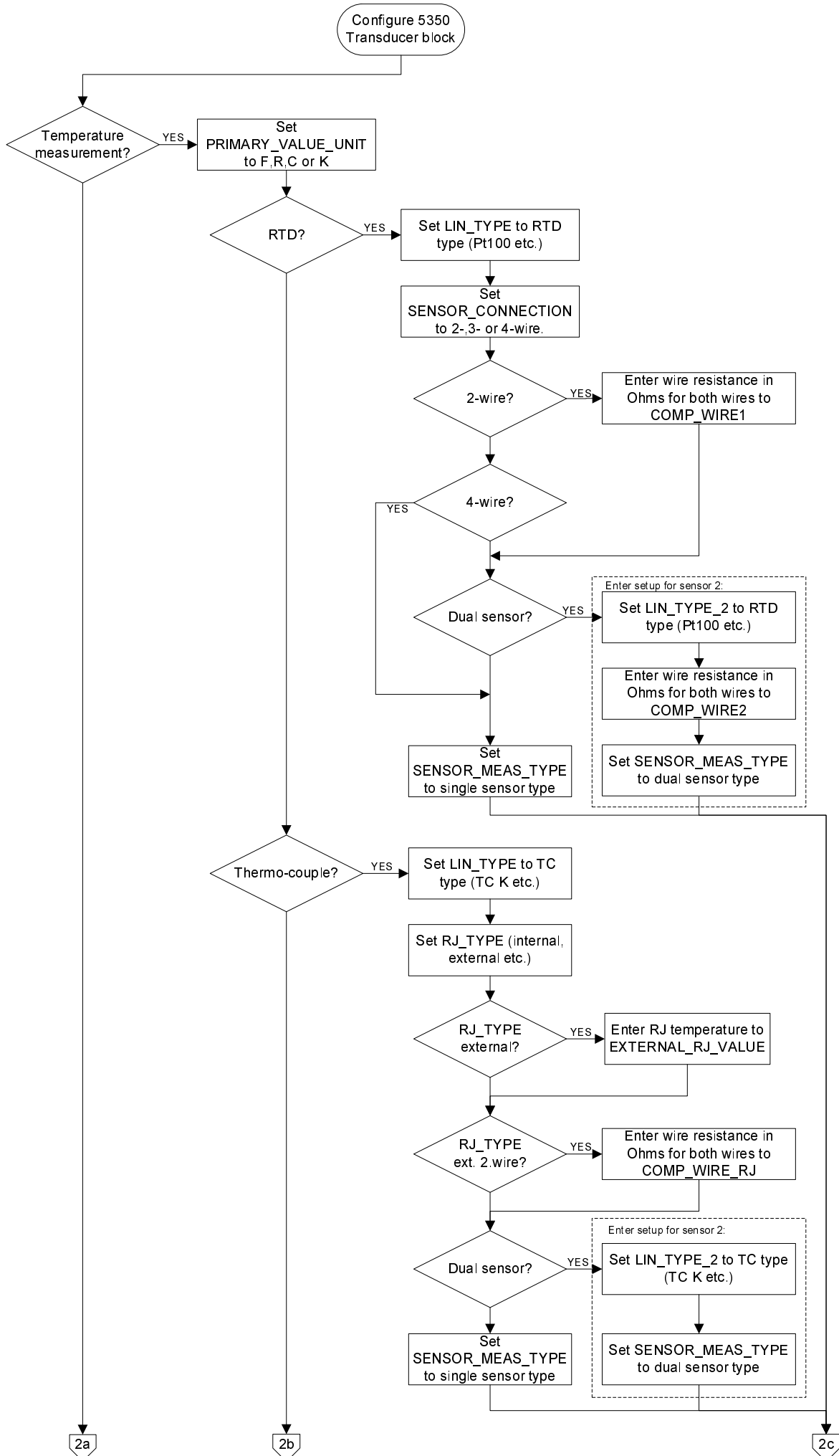

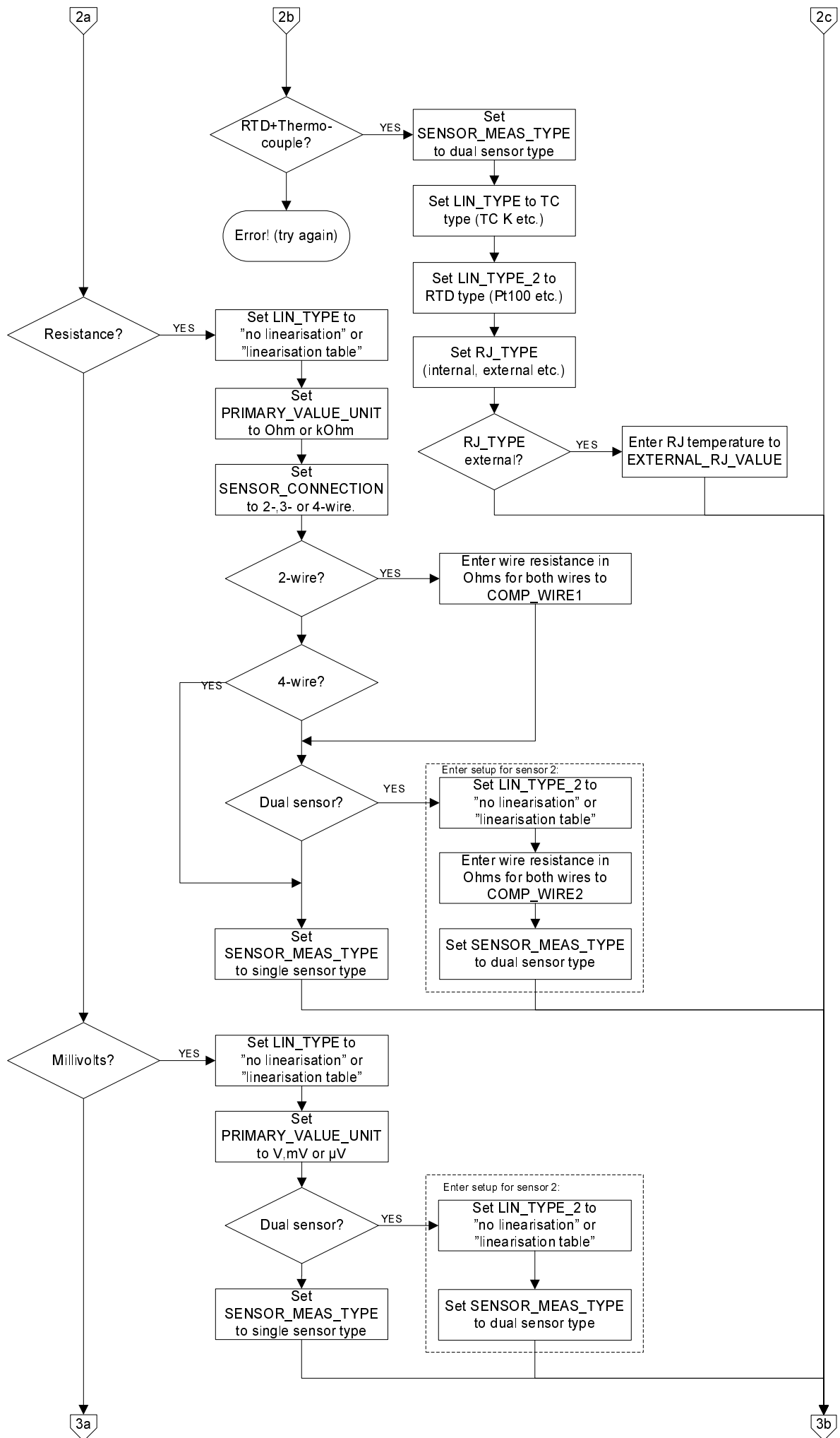

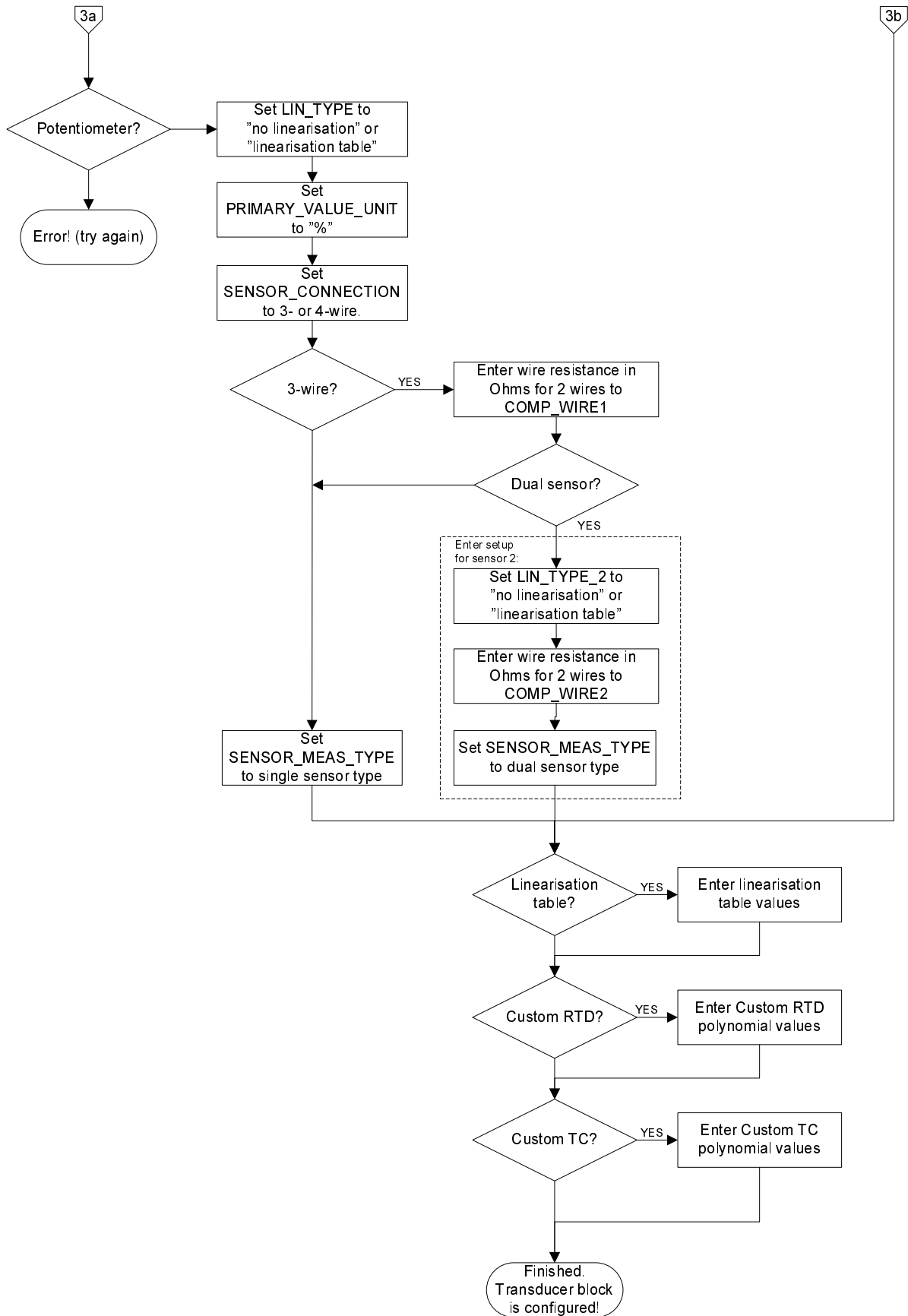

2.6 - Transducer Block Examples Setup

2.6.1 Measurement of RTD with one sensor:

PRIMARY_VALUE_UNIT = K, °C, °F or °R
 LIN_TYPE = Any RTD
 LIN_TYPE_2 = N/A (ignored in setup check)
 SENSOR_MEAS_TYPE = PV = SV_1, SV_2 not available
 SENSOR_CONNECTION . . . = 2-, 3- or 4-wire
 SENSOR_CONNECTION_2 . = N/A (ignored in setup check)
 RJ_TYPE = N/A (ignored in setup check)
 Connections:

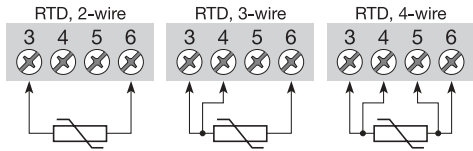

2.6.2 Measurement of RTD with two sensors:

PRIMARY_VALUE_UNIT = K, °C, °F or °R
 LIN_TYPE = Any RTD
 LIN_TYPE_2 = Any RTD
 SENSOR_MEAS_TYPE = Anything, but not "PV = SV_1, SV_2 not available"
 SENSOR_CONNECTION . . . = 2- or 3-wire
 SENSOR_CONNECTION_2 . = Default set to 2-wire
 RJ_TYPE = N/A (ignored in setup check)
 Connections:

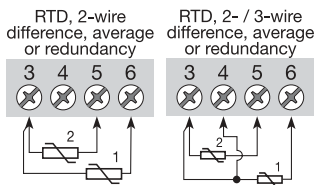

2.6.3 Measurement of thermocouple with one sensor:

PRIMARY_VALUE_UNIT = K, °C, °F or °R
 LIN_TYPE = Any TC
 LIN_TYPE_2 = N/A (ignored in setup check)
 SENSOR_MEAS_TYPE = PV = SV_1, SV_2 not available
 SENSOR_CONNECTION . . . = N/A (ignored in setup check)
 SENSOR_CONNECTION_2 . = N/A (ignored in setup check)
 RJ_TYPE = No Reference Junction, Internal, External (constant value),
 Sensor 2-wire or Sensor 3-wire

Connections:

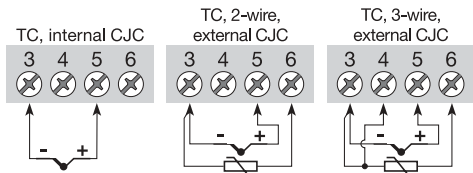

2.6.4 Measurement of thermocouple with two sensors:

- PRIMARY_VALUE_UNIT = K, °C, °F or °R
- LIN_TYPE = Any TC
- LIN_TYPE_2 = Any TC
- SENSOR_MEAS_TYPE = Anything, but not "PV = SV_1, SV_2 not available"
- SENSOR_CONNECTION . . . = N/A (ignored in setup check)
- SENSOR_CONNECTION_2 . . = N/A (ignored in setup check)
- RJ_TYPE = No RJ, Internal, External (constant value) or Sensor 2-wire

Connections:

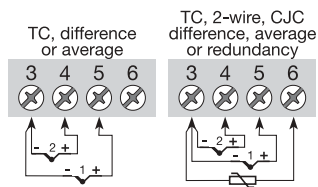

2.6.5 Measurement of combined sensors (Sensor 1 = TC and Sensor 2 = RTD):

- PRIMARY_VALUE_UNIT = K, °C, °F or °R
- LIN_TYPE = Any TC
- LIN_TYPE_2 = Any RTD
- SENSOR_MEAS_TYPE = Anything, but not "PV = SV_1, SV_2 not available"
- SENSOR_CONNECTION . . . = N/A (ignored in setup check)
- SENSOR_CONNECTION_2 . . = 2- or 3-wire
- RJ_TYPE = No Reference Junction, Internal, External (constant value)

Connections:

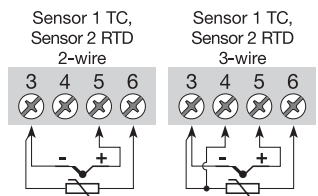

2.6.6 Measurement of resistance (linear) with one sensor:

- PRIMARY_VALUE_UNIT = Ohm or kOhm
- LIN_TYPE = No linearisation
- LIN_TYPE_2 = N/A (ignored in setup check)
- SENSOR_MEAS_TYPE = PV = SV_1, SV_2 not available
- SENSOR_CONNECTION . . . = 2-, 3- or 4-wire
- SENSOR_CONNECTION_2 . . = N/A (ignored in setup check)
- RJ_TYPE = N/A (ignored in setup check)

Connections:

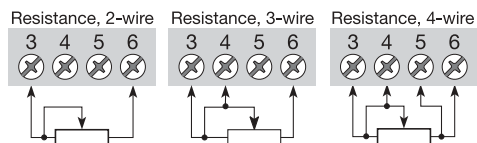

2.6.7 Measurement of resistance (linear) with two sensors:

- PRIMARY_VALUE_UNIT = Ohm or kOhm
- LIN_TYPE = No linearisation
- LIN_TYPE_2 = No linearisation
- SENSOR_MEAS_TYPE = Anything, but not "PV = SV_1, SV_2 not available"
- SENSOR_CONNECTION . . . = 2- or 3-wire
- SENSOR_CONNECTION_2 . = Default set to 2-wire
- RJ_TYPE = N/A (ignored in setup check)

Connections:

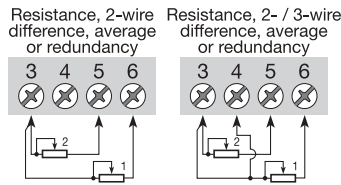

2.6.8 Measurement of potentiometer (linear) with one sensor:

- PRIMARY_VALUE_UNIT = %
- LIN_TYPE = No linearisation
- LIN_TYPE_2 = N/A (ignored in setup check)
- SENSOR_MEAS_TYPE = PV = SV_1, SV_2 not available
- SENSOR_CONNECTION . . . = 3- or 4-wire
- SENSOR_CONNECTION_2 . = N/A (ignored in setup check)
- RJ_TYPE = N/A (ignored in setup check)

Connections:

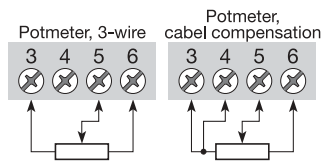

2.6.9 Measurement of potentiometer (linear) with two sensors:

- PRIMARY_VALUE_UNIT = %
- LIN_TYPE = No linearisation
- LIN_TYPE_2 = No linearisation
- SENSOR_MEAS_TYPE = Anything, but not "PV = SV_1, SV_2 not available"
- SENSOR_CONNECTION . . . = Default set to 3-wire
- SENSOR_CONNECTION_2 . = Default set to 3-wire
- RJ_TYPE = N/A (ignored in setup check)

Connections:

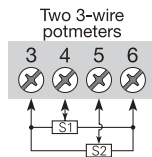

2.6.10 Measurement of voltage (linear) with one sensor:

- PRIMARY_VALUE_UNIT = μ V, mV or V
- LIN_TYPE = No linearisation
- LIN_TYPE_2 = N/A (ignored in setup check)
- SENSOR_MEAS_TYPE = PV = SV_1, SV_2 not available
- SENSOR_CONNECTION . . . = N/A (ignored in setup check)
- SENSOR_CONNECTION_2 . . = N/A (ignored in setup check)
- RJ_TYPE = N/A (ignored in setup check)

Connections:

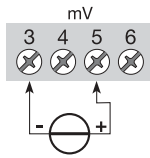

2.6.11 Measurement of voltage (linear) with two sensors:

- PRIMARY_VALUE_UNIT = μ V, mV or V
- LIN_TYPE = No linearisation
- LIN_TYPE_2 = No linearisation
- SENSOR_MEAS_TYPE = Anything, but not "PV = SV_1, SV_2 not available"
- SENSOR_CONNECTION . . . = N/A (ignored in setup check)
- SENSOR_CONNECTION_2 . . = N/A (ignored in setup check)
- RJ_TYPE = N/A (ignored in setup check)

Connections:

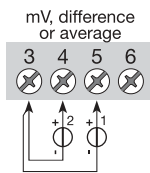

2.6.12 Measurement of 2 potentiometers (with Linear interpolation linearisation):

- PRIMARY_VALUE_UNIT = %
- LIN_TYPE = Table Linearisation
- LIN_TYPE_2 = Table Linearisation (same table as sensor 1)
- SENSOR_MEAS_TYPE = Anything, but not "PV = SV_1, SV_2 not available"
- SENSOR_CONNECTION . . . = Default set to 3-wire
- SENSOR_CONNECTION_2 . . = Default set to 3-wire
- RJ_TYPE = N/A (ignored in setup check)

Connections:

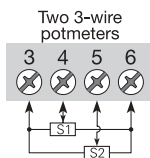

The coordinates (x,y) describing the linear interpolation linearisation must be entered in PR_CUST_LIN Block (PA Slot 4). See 2.9.2 Linear Interpolation Linearisation, Parameter List for further details.

Example:

The coordinates for converting the signal from a logarithmic potentiometer to a linear signal.

- TAB_ACTUAL_NUMBER = 10 (number of linearisation points to follow up to max 50)
- TAB_XY_VALUE1 = 0,0; -100
- TAB_XY_VALUE2 = 0,1; 0
- TAB_XY_VALUE3 = 0,2; 100
- TAB_XY_VALUE4 = 0,4; 200

TAB_XY_VALUE5 = 0,8; 300
 TAB_XY_VALUE6 = 1,6; 400
 TAB_XY_VALUE7 = 3,2; 500
 TAB_XY_VALUE8 = 6,4; 600
 TAB_XY_VALUE9 = 12,8; 700
 TAB_XY_VALUE10 = 25,6; 800

(Output will readout 325% with 1,0% potentiometer value)

2.6.13 Measurement of TC (with Custom Polynomial Linearisation) on sensor 1

PRIMARY_VALUE_UNIT = K, °C, °F or °R
 LIN_TYPE = Custom defined TC
 LIN_TYPE_2 = N/A (ignored in setup check)
 SENSOR_MEAS_TYPE = PV = SV_1, SV_2 not available
 SENSOR_CONNECTION = N/A (ignored in setup check)
 SENSOR_CONNECTION_2 = N/A (ignored in setup check)
 RJ_TYPE = No Reference Junction, Internal, External (constant value) or Sensor 2-wire or Sensor 3-wire

Connections:

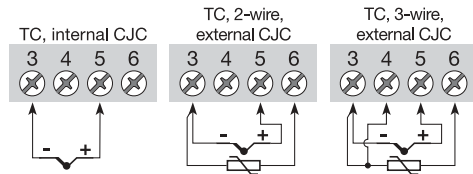

Now enter the Custom TC parameters in PR_CUST_LIN Block (PA Slot 4). See 2.9.4 Custom Polynomial Linearisation, Parameter List for further details.

Remember to enter values for the RJ polynomial if RJ_TYPE is any value other than “No reference Junction”.

Example:

The parameters and coefficients for converting a special TC to a linear temperature signal.

CUSTOM_TC_NAME = Custom TC Example
 CUSTOM_TC_POLY_COUNT = 5
 CUSTOM_TC_MIN_IN = -6500.0
 CUSTOM_TC_MIN_OUT = -100.0
 CUSTOM_TC_MAX_OUT = 1200.0

CUSTOM_TC_POLY_X	max. input limit in μV for POLY_X	4 th degree coefficient for POLY_X	3 th degree coefficient for POLY_X	2 th degree coefficient for POLY_X	1 st degree coefficient for POLY_X	0 degree coefficient for POLY_X
CUSTOM_TC_POLY_1	-3200.0	-3.84E-13	-5.65E-9	-3.36E-5	-6.10E-2	-8.44E1
CUSTOM_TC_POLY_2	3500.0	-8.13E-15	7.29E-11	-4.18E-7	2.53E-2	-1.08E-2
CUSTOM_TC_POLY_3	10000.0	-1.35E-15	1.50E-11	1.41E-7	2.26E-2	4.18
CUSTOM_TC_POLY_4	30000.0	3.49E-18	2.19E-12	-1.53E-7	2.68E-2	-9.26
CUSTOM_TC_POLY_5	70000.0	6.27E-17	-8.76E-12	5.34E-7	8.69E-3	1.65E2

	3 th degree coefficient	2 th degree coefficient	1 st degree coefficient	0 degree coefficient
CUSTOM_TC_RJ_POLY	-1.11E-4	2.65E-2	3.94E1	3.94E-1

A TC input of 5000 μV and an RJ temperature of 25°C will make POLY_3 the active and the output will be:

$$U_{RJ} = -3.94 \cdot 10^{-1} + 3.94 \cdot 10^1 \cdot 25 + 2.65 \cdot 10^{-2} \cdot 25^2 - 1.11 \cdot 10^{-4} \cdot 25^3 = 1000 \mu\text{V}$$

This voltage is to be added to the TC voltage (5000 + 1000), and the resulting temperature will be:

$$4.18 + 2.26 \cdot 10^{-2} \cdot 6000 + 1.41 \cdot 10^{-7} \cdot 6000^2 + 1.50 \cdot 10^{-11} \cdot 6000^3 - 1.35 \cdot 10^{-15} \cdot 6000^4 = 146.3 \text{ } ^\circ\text{C}$$

See 2.9.3 Custom polynomial linearisation, Description for formula and further details.

2.7 AI_Transducer and PR_CUST_LIN Block, Schematic

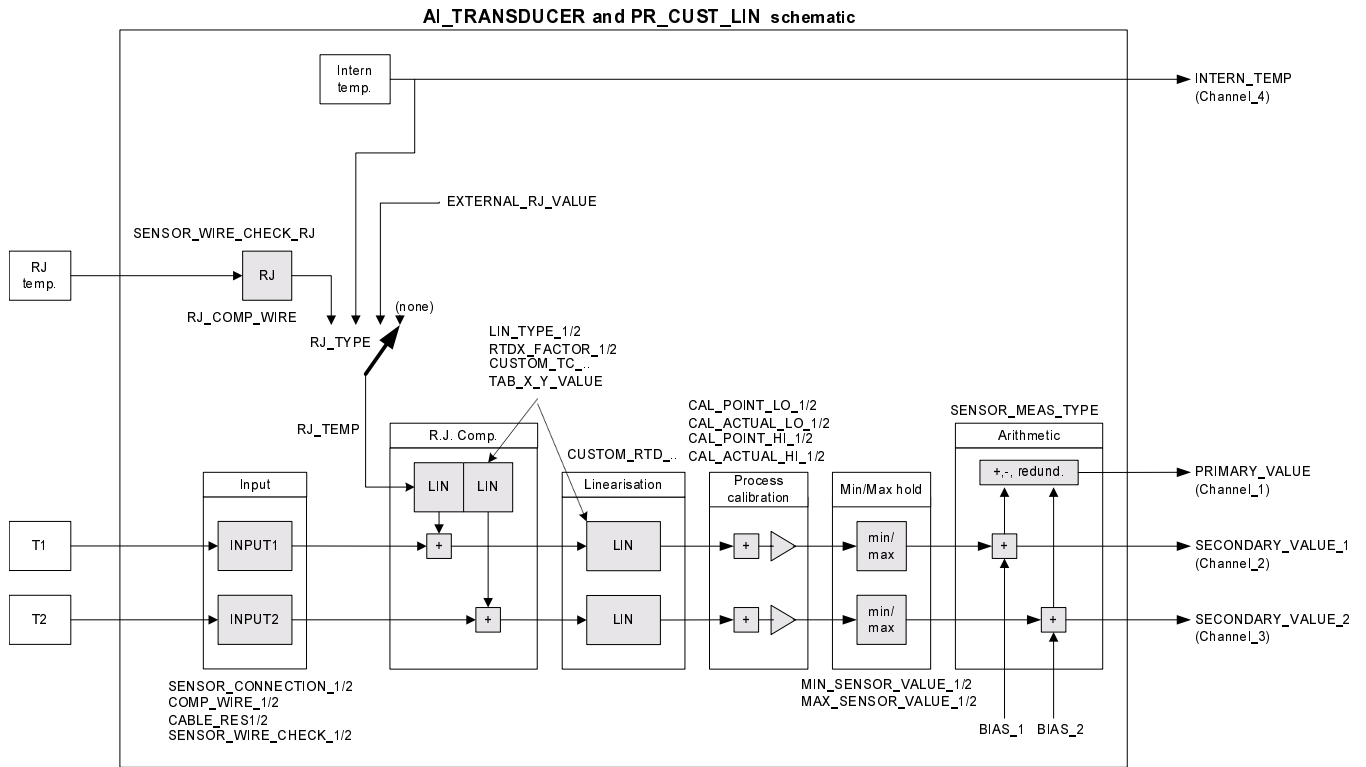

2.8 AI_TRANSDUCER Block (PA Slot 3) Parameter List

2.8.1 Sensor characterising parameters

Parameter	Rel. Index PA	Description	Type	Store	Size byte	RO / R/W	Min.	Max.	Default
PRIMARY_VALUE_UNIT	9	Selects the unit code of the PRIMARY_VALUE and other values. 1000 = K (Kelvin) 1001 = °C (degree Celsius) 1002 = °F (degree Fahrenheit) 1003 = Rk (Rankine) 1240 = V (volt) 1243 = mV millivolt 1244 = µV microvolt 1281 = Ohm Ohm 1284 = kOhm kiloOhm 1342 = % (percent)	Un-signed 16	SRC	2	R/W			1001 (°C)
LIN_TYPE	14	Select the type of sensor 1: 0 = no linearisation 1 = linearisation table 100 = RTD Pt10 a = 0.003850 (IEC 60751) 101 = RTD Pt50 a = 0.003850 (IEC 60751) 102 = RTD Pt100 a = 0.003850 (IEC 60751) 103 = RTD Pt200 a = 0.003850 (IEC 60751) 104 = RTD Pt500 a = 0.003850 (IEC 60751) 105 = RTD Pt1000 a = 0.003850 (IEC 60751) 106 = RTD Pt10 a = 0.003916 (JIS C1604-81) 107 = RTD Pt50 a = 0.003916 (JIS C1604-81) 108 = RTD Pt100 a = 0.003916 (JIS C1604-81) 122 = RTD Ni50 a = 0.006180 (DIN 43760) 123 = RTD Ni100 a = 0.006180 (DIN 43760) 124 = RTD Ni120 a = 0.006180 (DIN 43760) 125 = RTD Ni1000 a = 0.006180 (DIN 43760) 126 = RTD Cu10 a = 0.004270 127 = RTD Cu100 a = 0.004270 128 = TC Type B, Pt30Rh-Pt6Rh (IEC 584) 129 = TC Type C (W5), W5-W26Rh (ASTM E 988) 130 = TC Type D (W3), W3-W25Rh (ASTM E 988) 131 = TC Type E, Ni10Cr-Cu45Ni (IEC 584) 133 = TC Type J, Fe-Cu45Ni (IEC 584) 134 = TC Type K, Ni10Cr-Ni5 (IEC 584) 135 = TC Type N, Ni14CrSi-NiSi (IEC 584) 136 = TC Type R, Pt13Rh-Pt (IEC 584) 137 = TC Type S, Pt10Rh-Pt (IEC 584) 138 = TC Type T, Cu-Cu45Ni (IEC 584) 139 = TC Type L, Fe-CuNi (DIN 43710) 140 = TC Type U, Cu-CuNi (DIN 43710) 240 = Custom-defined TC 241 = Custom-defined RTD 242 = Custom-defined RTD PtX a=0.003850 (X factor of Pt1) 243 = Custom-defined RTD NiX a=0.006180 (X factor of Ni1) 244 = Custom-defined RTD CuX a=0.004270 (X factor of Cu1) 245 = Custom-defined RTD PtX a=0.003916 (X factor of Pt1)	Un-signed 8	SRC	1	R/W			102 (Pt100)
UPPER_SENSOR_LIMIT	21	Physical upper limit function of sensor1 (e.g. Pt 100 = 850°C) and input range. The unit of UPPER_SENSOR_LIMIT is the PRIMARY_VALUE_UNIT.	Float	N	4	RO			850
LOWER_SENSOR_LIMIT	22	Physical lower limit function of sensor1 (e.g. Pt 100 = -200°C) and input range. The unit of LOWER_SENSOR_LIMIT is the PRIMARY_VALUE_UNIT.	Float	N	4	RO			-200
LOWER_SENSOR_LIMIT_2	63	Physical lower limit function of sensor2 (e.g. Pt 100 = -200°C) and input range. The unit of LOWER_SENSOR_LIMIT is the PRIMARY_VALUE_UNIT.	Float	N	4	RO			-200
UPPER_SENSOR_LIMIT_2	64	Physical upper limit function of sensor2 (e.g. Pt 100 = +850°C) and input range. The unit of UPPER_SENSOR_LIMIT is the PRIMARY_VALUE_UNIT.	Float	N	4	RO			850
LIN_TYPE_2	65	Select the type of sensor 2: See LIN_TYPE for selection and supported types	Un-signed 8	SRC	1	R/W			102

AI_TRANSDUCER Block (PA Slot 3) Parameter List

2.8.2 RTD / Resistor specific parameters

Parameter	Rel. Index PA	Description	Type	Store	Size byte	RO / R/W	Min.	Max.	Default
SENSOR_CONNECTION	36	Connection to sensor 1, select for 2-, 3- and 4-wire connection. Ignored if sensor 1 is not a resistive sensor. Defined codes: 0 = 2 wires 1 = 3 wires 2 = 4 wires	Unsigned 8	SRC	1	R/W			1
COMP_WIRE1	37	Value in OHM to compensate line resistance when Sensor 1 is a resistive sensor, connected with 2 wires.	Float	SRC	4	R/W	0	100	0
COMP_WIRE2	38	Value in OHM to compensate line resistance when Sensor 2 is a resistive sensor, connected with 2 wires.	Float	SRC	4	R/W	0	100	0
SENSOR_CONNECTION_2	62	Connection to sensor 2, select for 2-, 3- and 4-wire connection. Ignored if sensor 2 is not a resistive sensor. Defined codes: 0 = 2 wires 1 = 3 wires	Unsigned 8	SRC	1	R/W			0
CABLE_RES1	87	For 3- or 4-wire resistance measurements. Indicates the measured cable resistance in the wire connected to terminal 3. For 3-wire measurements it is multiplied by 2	Float	D	4	RO			0,0
CABLE_RES2	88	For 4-wire resistance measurements. Indicates the measured cable resistance in the wire connected to terminal 6.	Float	D	4	RO			0,0
RTDX_FACTOR_1	89	Indicates the X factor for custom defined PtX, NiX, CuX for LIN_TYPE	Unsigned 16	SRC	2	R/W			100
RTDX_FACTOR_2	90	Indicates the X factor for custom defined PtX, NiX, CuX for LIN_TYPE_2	Unsigned 16	SRC	2	R/W			100

2.8.3 Thermocouple specific parameters

Parameter	Rel. Index PA	Description	Type	Store	Size byte	RO / R/W	Min.	Max.	Default
RJ_TEMP	33	Reference junction temperature. The unit of RJ_TEMP is the PRIMARY_VALUE_UNIT. If PRIMARY_VALUE_UNIT is no temperature unit (e.g. mV) RJ_TEMP is stated in °C.	Float	D	4	RO			0
RJ_TYPE	34	Select reference junction from internal to fixed value. Ignored for sensors which are not thermocouple types. Defined codes: 0 = No reference: Compensation is not used (e.g. for TC type B). 1 = Internal: Reference junction temperature is measured by the device itself, via an internally mounted sensor. 2 = External: The fixed value EXTERNAL_RJ_VALUE is used for compensation. The reference junction must be kept at a constant temperature (e.g. by a reference junction thermostat). 3 = Sensor, 2-w.: Reference junction temperature is measured by external 2-wire connected Pt100 sensor. 4 = Sensor, 3-w.: Reference junction temperature is measured by external 3-wire connected Pt100 sensor.	Unsigned 8	SRC	1	R/W			0
EXTERNAL_RJ_VALUE	35	Fixed temperature value of an external reference junction. The unit of EXTERNAL_RJ_VALUE is the PRIMARY_VALUE_UNIT. If PRIMARY_VALUE_UNIT is no temperature unit (e.g. mV) EXTERNAL_RJ_VALUE is stated in °C.	Float	SRC	4	R/W	-40 (°C)	135 (°C)	0
RJ_COMP_WIRE	66	Value in OHM to compensate line resistance when External RJ sensor, connected with 2 wires is used.	Float	SRC	4	R/W	0	100	0

AI_TRANSDUCER Block (PA Slot 3) Parameter List

2.8.4 Output conditioning parameters

Parameter	Rel. Index PA	Description	Type	Store	Size byte	RO / R/W	Min.	Max.	Default
SENSOR_MEAS_TYPE	12	Mathematical function to calculate PRIMARY_VALUE (PV). Defined codes: 0: PV = SV_1 1: PV = SV_2 128: PV = SV_1 - SV_2 Difference 129: PV = SV_2 - SV_1 Difference 192: PV = $\frac{1}{2} * (SV_1 + SV_2)$ Average 193: PV = $\frac{1}{2} * (SV_1 + SV_2)$ Average, but SV_1 or SV_2 if the other is wrong (input_fault_x \neq 0) 220: PV = SV_1, SV_2 not available. Used for single sensor applications. If selected, Sensor 2 will not be measured. All parameters exclusively related to Sensor 2 are not available, and no alarms will be generated for Sensor 2. 221: PV = SV_1, but SV_2 if SV_1 is wrong (INPUT_FAULT_1 \neq 0) 222: PV = SV_2, but SV_1 if SV_2 is wrong (INPUT_FAULT_2 \neq 0)	Un-signed 8	SRC	1	R/W			220
BIAS_1	19	Bias that can be algebraically added to process value of sensor 1, SV1. The unit of BIAS_1 is the PRIMARY_VALUE_UNIT.	Float	SRC	4	R/W			0
BIAS_2	20	Bias that can be algebraically added to process value of sensor 2, SV2. The unit of BIAS_2 is the PRIMARY_VALUE_UNIT.	Float	SRC	4	R/W			0
MAX_SENSOR_VALUE_1	29	Holds the maximum SECONDARY_VALUE_1. The unit is defined in SECONDARY_VALUE_1.	Float	N	4	R/W			0
MIN_SENSOR_VALUE_1	30	Holds the minimum SECONDARY_VALUE_1. The unit is defined in SECONDARY_VALUE_1.	Float	N	4	R/W			0
MAX_SENSOR_VALUE_2	31	See. MAX_SENSOR_VALUE_1	Float	N	4	R/W			0
MIN_SENSOR_VALUE_2	32	See. MIN_SENSOR_VALUE_1	Float	N	4	R/W			0

2.8.5 Output parameters

Parameter	Rel. Index PA	Description	Type	Store	Size byte	RO / R/W	Min.	Max.	Default
PRIMARY_VALUE	8	Process value, function determined by SENSOR_MEAS_TYPE of SECONDARY_VALUE_1/2. The unit of PRIMARY_VALUE is the PRIMARY_VALUE_UNIT. FF Channel 1 Output, PA Channel 280	DS-33	D	5	RO			0
SECONDARY_VALUE_1	10	Process value connected to sensor 1 corrected by BIAS_1. The unit of SECONDARY_VALUE_1 is the PRIMARY_VALUE_UNIT. FF Channel 2 Output, PA Channel 282	DS-33	D	5	RO			0
SECONDARY_VALUE_2	11	Process value connected to sensor 2 corrected by BIAS_2. The unit of SECONDARY_VALUE_2 is the PRIMARY_VALUE_UNIT. FF Channel 3 Output, PA Channel 283	DS-33	D	5	RO			0
INTERN_TEMP	69	Internal electronics temperature. The unit of INTERN_TEMP is the PRIMARY_VALUE_UNIT. If PRIMARY_VALUE_UNIT is no temperature unit (e.g. mV) INTERN_TEMP is stated in °C. FF Channel 4 Output, PA Channel 341	DS-33	D	5	RO			0

AI_TRANSDUCER Block (PA Slot 3) Parameter List

2.8.6 Diagnostic parameters

Parameter	Rel. Index PA	Description	Type	Store	Size byte	RO / R/W	Min.	Max.	Default
INPUT_FAULT_GEN	24	Input malfunction: Diagnosis object for errors that concern all values 0 = device OK Bit: 0 = Rj error 1 = Hardware error 2 – 4 = reserved 5 – 7 = manufacturer-specific	Un-signed 8	D	1	RO			0
INPUT_FAULT_1	25	Input malfunction: Diagnosis object for errors that concern SV_1 0 = Input OK Bit: 0 = underrange 1 = overrange 2 = lead breakage 3 = short circuit 4 – 5 = reserved 6 – 7 = manufacturer-specific	Un-signed 8	D	1	RO			0
INPUT_FAULT_2	26	Input malfunction: Diagnosis object for errors that concern SV_2 0 = Input OK Bit definition see INPUT_FAULT_1	Un-signed 8	D	1	RO			0
RJ_FAULT	67	Input malfunction: Diagnosis object for errors that concern RJ sensor. 0 = Input OK Bit: 0 = underrange 1 = overrange 2 = lead breakage 3 = short circuit	Un-signed 8	D	1	RO			0
HW_ERROR	86	Diagnostic bit value indicating hardware status 0 = hardware OK Bit: 0 = Input power supply error 1 = Input initialisation error 2 = Input communication error 3 = Internal temperature sensor error 4 = Device not factory calibrated 5 – 6 = reserved 7 = Watchdog initiated cold start occurred	Un-signed 8	D	1	RO			0

2.8.7 Sensor error detection parameters

Parameter	Rel. Index PA	Description	Type	Store	Size byte	RO / R/W	Min.	Max.	Default
SENSOR_WIRE_CHECK_1	27	Enables lead breakage and short circuit detection for Sensor 1. List of valid values: 0 =Lead breakage and short circuit detection enable. 1 =Lead breakage detection enable, short circuit detection disable. 2 =Lead breakage detection disable, short circuit detection enable. 3 =Lead breakage and short circuit detection disable.	Un-signed 8	SRC	1	R/W			3
SENSOR_WIRE_CHECK_2	28	Enables lead breakage and short circuit detection for Sensor 2. Valid values: see SENSOR_WIRE_CHECK_1.	Un-signed 8	SRC	1	R/W			3
SENSOR_WIRE_CHECK_RJ	68	Enables lead breakage and short circuit detection for RJ Sensor. Valid values: see SENSOR_WIRE_CHECK_1.	Un-signed 8	SRC	1	R/W			3

AI_TRANSDUCER Block (PA Slot 3) Parameter List

2.8.8 Sensor calibration, Description

Sensor calibration is a very useful function when the transmitter output needs to be adjusted to the sensor signal, e.g. when the temperature sensor does not correspond to the ideal values for the selected temperature range. The results depend on the accuracy of the calibrator or reference equipment. In the following a temperature sensor calibration is described, however the principle can be used for all input types.

SENSOR_CAL_METHOD_1 / 2 defines the use of either "Factory trim Standard" (the factory defined values calculated according to the valid norms) or "User Trim Standard" (the sensor calibrated values) in the transmitter for sensor 1 and 2 respectively. During sensor calibration SENSOR_CAL_METHOD_1 / 2 must be set to "Factory trim Standard" = 103.

The sensor calibration function in PR5350 will change the slope of the linearisation curve so the curve is adjusted to the connected sensor. To obtain accurate temperature measurement in the range e.g. 0...100 °C apply to the sensor a temperature e.g. of 5 °C as the low temperature and e.g. 95 °C as the high temperature through a precise temperature calibrator.

At sensor calibration the succeeding procedure must be followed precisely (Example: sensor 1):

1. SENSOR_CAL_METHOD_1 = 103
2. Apply the low temperature of the calibrator to the sensor
3. CAL_POINT_LO_1 = 5.00 (type in the low temperature of the calibrator)
4. CAL_ACTUAL_LO_1 = 1.00 (The measurement of the deviation starts by typing in a random value)
5. Apply the high temperature of the calibrator to the sensor
6. CAL_POINT_HI_1 = 95.00 (type in the high temperature of the calibrator)
7. CAL_ACTUAL_HI_1 = 1.00 (The measurement of the deviation starts by typing in a random value and PR5350 calculates the curve slope according to the measured deviations.)
8. SENSOR_CAL_METHOD_1 = 104 (the sensor calibration just carried out is used)

2.8.9 Sensor Calibration Parameters

Parameter	Rel. Index PA	Description	Type	Store	Size byte	RO / R/W	Min.	Max.	Default
CAL_POINT_LO_1	70	The low calibration value applied to sensor 1 The value from either a calibrator or a reference equipment.	Float	SRC	4	R/W			-10 ³⁸
CAL_ACTUAL_LO_1	71	Entering any value will force the device to automatically measure and store the actual low point value. Must be entered with the applied CAL_POINT_LO_1 value	Float	SRC	4	R/W			-10 ³⁸
CAL_POINT_HI_1	72	The high calibration value applied to sensor 1 The value from either a calibrator or a reference equipment.	Float	SRC	4	R/W			10 ³⁸
CAL_ACTUAL_HI_1	73	Entering any value will force the device to automatically measure and store the actual high point value. Must be entered with the applied CAL_POINT_HI_1 value	Float	SRC	4	R/W			10 ³⁸
SENSOR_CAL_METHOD_1	74	Enables or disables the last sensor calibration for sensor 1 103 = Factory trim standard (calibration values disabled) 104 = User trim standard (calibration values enabled)	Unsigned 8	SRC	1	R/W			103
SENSOR_CAL_LOC_1	75	The last location of the calibrated sensor	OCTET_STRING	SRC	32	R/W			" "
SENSOR_CAL_DATE_1	76	The last date on which the calibration was performed	7 * Unsigned 8	SRC	7	R/W			0,0,0,0,1,1,103
SENSOR_CAL_WHO_1	77	The name of the person responsible for the last sensor calibration	OCTET_STRING	SRC	32	R/W			" "
CAL_POINT_LO_2	78	The low calibration value applied to sensor 2 The value from either a calibrator or a reference equipment.	Float	SRC	4	R/W			-10 ³⁸
CAL_ACTUAL_LO_2	79	Entering any value will force the device to automatically measure and store the actual low point value. Must be entered with the applied CAL_POINT_LO_2 value	Float	SRC	4	R/W			-10 ³⁸

Parameter	Rel. Index PA	Description	Type	Store	Size byte	RO / R/W	Min.	Max.	Default
CAL_POINT_HI_2	80	The high calibration value applied to sensor 2 The value from either a calibrator or a reference equipment.	Float	SRC	4	R/W			10 ³⁸
CAL_ACTUAL_HI_2	81	Entering any value will force the device to automatically measure and store the actual high point value. Must be entered with the applied CAL_POINT_HI_2 value	Float	SRC	4	R/W			10 ³⁸
SENSOR_CAL_METHOD_2	82	Enables or disables the last sensor calibration for sensor 2 103 = Factory trim standard (calibration values disabled) 104 = User trim standard (calibration values enabled)	Unsigned 8	SRC	1	R/W			103
SENSOR_CAL_LOC_2	83	The last location of the calibrated sensor	OCTET_STRING	SRC	32	R/W			» »
SENSOR_CAL_DATE_2	84	The last date on which the calibration was performed	7 * Unsigned 8	SRC	7	R/W			0,0,0,0,1,1,103
SENSOR_CAL_WHO_2	85	The name of the person responsible for the last sensor calibration	OCTET_STRING	SRC	32	R/W			» »

2.9 PR_CUST_LIN Block (PA Slot 4) Parameter List

2.9.1 Linear interpolation linearisation, Description

LinType 1 = "Linearisation Table" generates a customer specific linear interpolation linearisation. Linear interpolation linearisation can be used on mV, ohmic and potentiometer signals. The linear interpolation linearisation is defined by straight lines drawn between the entered X / Y (input / output) coordinates. The linearisation table must consist of 10 to 50 coordinate sets. The X values of the coordinates must be entered in ascending order. The lowest and highest X values function as the lower and the upper limit respectively. All X values must be entered as μV , Ohm or % for Voltage, Resistance or Potentiometer measurements in that order. The table output will be converted to actual chosen PRIMARY_VALUE_UNIT (Example: 1000 / 3000 as X / Y values: output will read 3,00 if PRIMARY_VALUE_UNIT is set to "mV" and 1 mV is connected to input).

2.9.2 Linear Interpolation Linearisation, Parameter List.

Parameter	Rel. Index PA	Description	Type	Store	Size byte	RO / R/W	Min.	Max.	Default
TAB_MIN_NUMBER	29	Minimum number of linearisation points allowed (10)	Un-signed 8	N	1	RO			10
TAB_MAX_NUMBER	30	Maximum number of linearisation points allowed (50)	Un-signed 8	N	1	RO			50
TAB_ACTUAL_NUMBER	31	Number of linearisation points in the linearisation table.	Un-signed 8	SRC	1	R/W			11
TAB_X_Y_VALUE1	32	Linearisation x,y coordinate 1	Float array	SRC	8	R/W			0, 0
TAB_X_Y_VALUE2	33	Linearisation x,y coordinate 2	Float array	SRC	8	R/W			1000, 100
TAB_X_Y_VALUE3	34	Linearisation x,y coordinate 3	Float array	SRC	8	R/W			2000, 200
TAB_X_Y_VALUE4	35	Linearisation x,y coordinate 4	Float array	SRC	8	R/W			3000, 300
TAB_X_Y_VALUE5	36	Linearisation x,y coordinate 5	Float array	SRC	8	R/W			4000, 400
TAB_X_Y_VALUE6	37	Linearisation x,y coordinate 6	Float array	SRC	8	R/W			5000, 500
TAB_X_Y_VALUE7	38	Linearisation x,y coordinate 7	Float array	SRC	8	R/W			6000, 600
TAB_X_Y_VALUE8	39	Linearisation x,y coordinate 8	Float array	SRC	8	R/W			7000, 700
TAB_X_Y_VALUE9	40	Linearisation x,y coordinate 9	Float array	SRC	8	R/W			8000, 800
TAB_X_Y_VALUE10	41	Linearisation x,y coordinate 10	Float array	SRC	8	R/W			9000, 900
TAB_X_Y_VALUE11	42	Linearisation x,y coordinate 11	Float array	SRC	8	R/W			10000, 1000
TAB_X_Y_VALUE12	43	Linearisation x,y coordinate 12	Float array	SRC	8	R/W			0, 0
TAB_X_Y_VALUE13	44	Linearisation x,y coordinate 13	Float array	SRC	8	R/W			0, 0
TAB_X_Y_VALUE14	45	Linearisation x,y coordinate 14	Float array	SRC	8	R/W			0, 0
TAB_X_Y_VALUE15	46	Linearisation x,y coordinate 15	Float array	SRC	8	R/W			0, 0
TAB_X_Y_VALUE16	47	Linearisation x,y coordinate 16	Float array	SRC	8	R/W			0, 0
TAB_X_Y_VALUE17	48	Linearisation x,y coordinate 17	Float array	SRC	8	R/W			0, 0
TAB_X_Y_VALUE18	49	Linearisation x,y coordinate 18	Float array	SRC	8	R/W			0, 0
TAB_X_Y_VALUE19	50	Linearisation x,y coordinate 19	Float array	SRC	8	R/W			0, 0
TAB_X_Y_VALUE20	51	Linearisation x,y coordinate 20	Float array	SRC	8	R/W			0, 0
TAB_X_Y_VALUE21	52	Linearisation x,y coordinate 21	Float array	SRC	8	R/W			0, 0
TAB_X_Y_VALUE22	53	Linearisation x,y coordinate 22	Float array	SRC	8	R/W			0, 0

Parameter	Rel. Index PA	Description	Type	Store	Size byte	RO / R/W	Min.	Max.	Default
TAB_X_Y_VALUE23	54	Linearisation x,y coordinate 23	Float array	SRC	8	R/W			0, 0
TAB_X_Y_VALUE24	55	Linearisation x,y coordinate 24	Float array	SRC	8	R/W			0, 0
TAB_X_Y_VALUE25	56	Linearisation x,y coordinate 25	Float array	SRC	8	R/W			0, 0
TAB_X_Y_VALUE26	57	Linearisation x,y coordinate 26	Float array	SRC	8	R/W			0, 0
TAB_X_Y_VALUE27	58	Linearisation x,y coordinate 27	Float array	SRC	8	R/W			0, 0
TAB_X_Y_VALUE28	59	Linearisation x,y coordinate 28	Float array	SRC	8	R/W			0, 0
TAB_X_Y_VALUE29	60	Linearisation x,y coordinate 29	Float array	SRC	8	R/W			0, 0
TAB_X_Y_VALUE30	61	Linearisation x,y coordinate 30	Float array	SRC	8	R/W			0, 0
TAB_X_Y_VALUE31	62	Linearisation x,y coordinate 31	Float array	SRC	8	R/W			0, 0
TAB_X_Y_VALUE32	63	Linearisation x,y coordinate 32	Float array	SRC	8	R/W			0, 0
TAB_X_Y_VALUE33	64	Linearisation x,y coordinate 33	Float array	SRC	8	R/W			0, 0
TAB_X_Y_VALUE34	65	Linearisation x,y coordinate 34	Float array	SRC	8	R/W			0, 0
TAB_X_Y_VALUE35	66	Linearisation x,y coordinate 35	Float array	SRC	8	R/W			0, 0
TAB_X_Y_VALUE36	67	Linearisation x,y coordinate 36	Float array	SRC	8	R/W			0, 0
TAB_X_Y_VALUE37	68	Linearisation x,y coordinate 37	Float array	SRC	8	R/W			0, 0
TAB_X_Y_VALUE38	69	Linearisation x,y coordinate 38	Float array	SRC	8	R/W			0, 0
TAB_X_Y_VALUE39	70	Linearisation x,y coordinate 39	Float array	SRC	8	R/W			0, 0
TAB_X_Y_VALUE40	71	Linearisation x,y coordinate 40	Float array	SRC	8	R/W			0, 0
TAB_X_Y_VALUE41	72	Linearisation x,y coordinate 41	Float array	SRC	8	R/W			0, 0
TAB_X_Y_VALUE42	73	Linearisation x,y coordinate 42	Float array	SRC	8	R/W			0, 0
TAB_X_Y_VALUE43	74	Linearisation x,y coordinate 43	Float array	SRC	8	R/W			0, 0
TAB_X_Y_VALUE44	75	Linearisation x,y coordinate 44	Float array	SRC	8	R/W			0, 0
TAB_X_Y_VALUE45	76	Linearisation x,y coordinate 45	Float array	SRC	8	R/W			0, 0
TAB_X_Y_VALUE46	77	Linearisation x,y coordinate 46	Float array	SRC	8	R/W			0, 0
TAB_X_Y_VALUE47	78	Linearisation x,y coordinate 47	Float array	SRC	8	R/W			0, 0
TAB_X_Y_VALUE48	79	Linearisation x,y coordinate 48	Float array	SRC	8	R/W			0, 0
TAB_X_Y_VALUE49	80	Linearisation x,y coordinate 49	Float array	SRC	8	R/W			0, 0
TAB_X_Y_VALUE50	81	Linearisation x,y coordinate 50	Float array	SRC	8	R/W			0, 0

2.9.3 Custom polynomial linearisation, Description

Polynomial linearisation can be used on mV and ohmic input signals. Polynomial linearisation is executed according to the function $f(x) = a_0 + a_1 \cdot x + a_2 \cdot x^2 + a_3 \cdot x^3 + a_4 \cdot x^4$, in which $a_0 \dots a_4$ equal the coefficients for a fourth order polynomial and x equals the input value. This function requires that the user can obtain or calculate the coefficients of up to 5 fourth order polynomials. Various computer programs such as Math Cad can calculate these coefficients. If the preceding text is unfamiliar one should use the function table linearisation in case of customer specific linearisation.

LIN_TYPE 240 = "Custom defined TC" generates a customer specific polynomial linearisation. The function is primarily suitable for specific thermo elements but also for millivolt signals if the user can accept to enter the input and the output values of the polynomial in μV and $^\circ\text{C}$ respectively.

LIN_TYPE 241 = "Custom defined RTD" generates a customer specific polynomial linearisation. The

function is particularly suitable for specific RTD sensors but also for non-linear ohmic signals if the user can accept to enter the input and output values of the polynomials in ohm and °C respectively. Please remember that polynomial linearisation is absolute. The output value is calculated continuously according to the applied input value and the function formula. The max. input range can be limited precisely to the input range in which the polynomial linearisation will be used. The PRIMARY_VALUE_UNIT defines the unit of the values provided by the AI_TRANSDUCER BLOCK. The parameter OUT_SCALE in the AI block can scale the values and change the unit to e.g. mV or ohm.

2.9.4 Custom Polynomial Linearisation, Parameter List

Parameter	Rel. Index PA	Description	Type	Store	Size byte	RO / R/W	Min.	Max.	Default
CUSTOM_TC_NAME	8	Name of Custom defined TC (LIN_TYPE = 240)	OCTET_STRING	SRC	20	R/W			*Linear TC; no RJ*
CUSTOM_TC_POLY_COUNT	9	Number of 4. order polynomial parts for Custom defined TC	Unsigned 8	SRC	1	R/W			5
CUSTOM_TC_MIN_IN	10	Minimum input limit in µV for Custom defined TC	Float	SRC	4	R/W			0
CUSTOM_TC_MIN_OUT	11	Minimum usable output value in °C of polynomial set for Custom defined TC	Float	SRC	4	R/W			0
CUSTOM_TC_MAX_OUT	12	Maximum usable output value in °C of polynomial set for Custom defined TC	Float	SRC	4	R/W			1500,00
CUSTOM_TC_POLY_1	13	Polynomial part 1 of Custom defined TC converting µV to °C. Consisting of: maximum input value in µV, a4..a0 polynomial coefficients.	6*Float	SRC	24	R/W			30000; 0; 0; 0; 0,01; 0
CUSTOM_TC_POLY_2	14	Polynomial part 2 of Custom defined TC converting µV to °C. Consisting of: maximum input value in µV, a4..a0 polynomial coefficients.	6*Float	SRC	24	R/W			60000; 0; 0; 0; 0,01; 0
CUSTOM_TC_POLY_3	15	Polynomial part 3 of Custom defined TC converting µV to °C. Consisting of: maximum input value in µV, a4..a0 polynomial coefficients.	6*Float	SRC	24	R/W			90000; 0; 0; 0; 0,01; 0
CUSTOM_TC_POLY_4	16	Polynomial part 4 of Custom defined TC converting µV to °C. Consisting of: maximum input value in µV, a4..a0 polynomial coefficients.	6*Float	SRC	24	R/W			120000; 0; 0; 0; 0,01; 0
CUSTOM_TC_POLY_5	17	Polynomial part 5 of Custom defined TC converting µV to °C. Consisting of: maximum input value in µV, a4..a0 polynomial coefficients.	6*Float	SRC	24	R/W			150000; 0; 0; 0; 0,01; 0
CUSTOM_TC_RJ_POLY	18	RJ Polynomial part of custom defined TC, converting °C to µV.: a3..a0 coefficients.	4*Float	SRC	16	R/W			0;0;0;0
CUSTOM_RTD_NAME	19	Name of Custom defined RTD (LIN_TYPE = 241)	OCTET_STRING	SRC	20	R/W			"Linear RTD"
CUSTOM_RTD_POLY_COUNT	20	Number of 4. order polynomial parts for Custom defined RTD	Unsigned 8	SRC	1	R/W			5
CUSTOM_RTD_MIN_IN	21	Minimum input limit in Ohm's for Custom defined RTD	Float	SRC	4	R/W			0
CUSTOM_RTD_MIN_OUT	22	Minimum usable output value of polynomial set for Custom defined RTD	Float	SRC	4	R/W			0
CUSTOM_RTD_MAX_OUT	23	Maximum useable output value of polynomial set for Custom defined RTD	Float	SRC	4	R/W			100,00
CUSTOM_RTD_POLY_1	24	Polynomial part 1 of Custom defined RTD converting Ohm to °C. Consisting of maximum input value in Ohms, a4..a0 polynomial coefficients.	6*Float	SRC	24	R/W			2000; 0; 0; 0; 0,01; 0
CUSTOM_RTD_POLY_2	25	Polynomial part 2 of Custom defined RTD converting Ohm to °C. Consisting of maximum input value in Ohms, a4..a0 polynomial coefficients.	6*Float	SRC	24	R/W			4000; 0; 0; 0; 0,01; 0
CUSTOM_RTD_POLY_3	26	Polynomial part 3 of Custom defined RTD converting Ohm to °C. Consisting of maximum input value in Ohms, a4..a0 polynomial coefficients.	6*Float	SRC	24	R/W			6000; 0; 0; 0; 0,01; 0
CUSTOM_RTD_POLY_4	27	Polynomial part 4 of Custom defined RTD converting Ohm to °C. Consisting of maximum input value in Ohms, a4..a0 polynomial coefficients.	6*Float	SRC	24	R/W			8000; 0; 0; 0; 0,01; 0
CUSTOM_RTD_POLY_5	28	Polynomial part 5 of Custom defined RTD converting Ohm to °C. Consisting of maximum input value in Ohms, a4..a0 polynomial coefficients.	6*Float	SRC	24	R/W			10000; 0; 0; 0; 0,01; 0

2.10 PR_CUST_PRIV Block (PA Slot 5) Reserved Parameter List

2.10.1 Description, PR_CUST_PRIV Block

The Block is private and reserved.

3.0 Analogue Input Blocks, Profibus

3.1 Analogue Input Blocks Overview, Profibus

Analog Input Function Blocks represent transmitters. The parameters are shown in Figure 1.

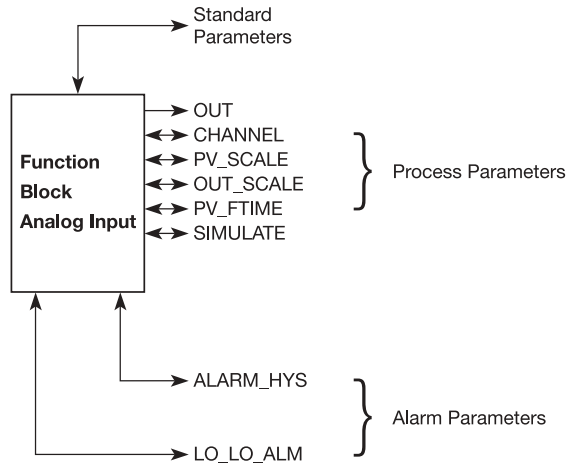

Figure 1: Summary of the parameter of Analog Input Function Blocks.

The structure of the MODE and the simulation feature of the AI is shown in Figure 2.

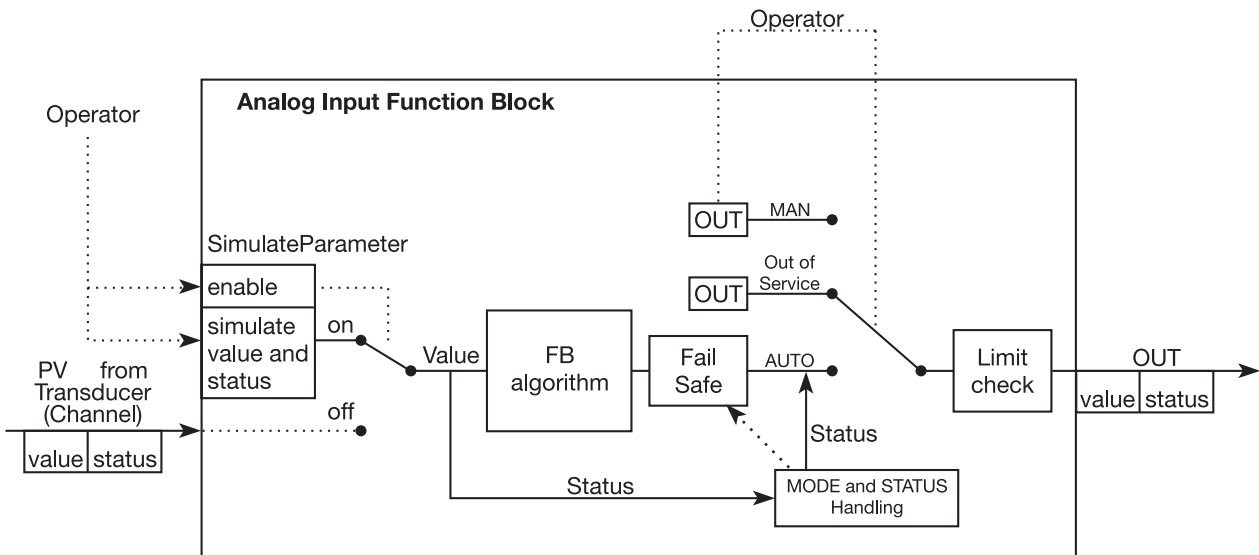

Figure 2: Simulation, Mode and Status diagram of Analog Input Function Block

The structure of the AI with Simulation, Mode and Status is shown in Figure 2. More details about the relationships between the AI parameters are visible in Figure 3.

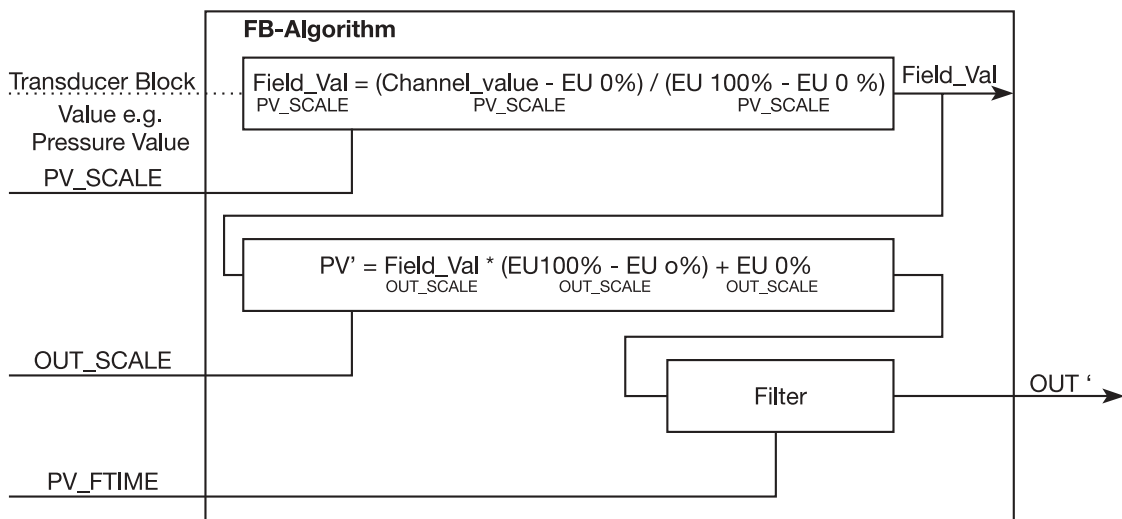

Figure 3: Parameter relationship of AI FB

3.2 Analogue Input Blocks (PA Slot 1 & 2) Parameter List, Profibus

Parameter	Rel. Index	Description	Type	Store	Size byte	RO / R/W	Min.	Max.	Default
ST_REV	1	Static Revision. Counter incremented with every parameter configuration change.	Unsigned 16	N	2	RO			0
TAG_DESC	2	A user-supplied description of the block.	Octet string	SRC	32	R/W			" "
STRATEGY	3	Grouping of Function Block. The STRATEGY field can be used to group blocks.	Unsigned 16	SRC	2	R/W			0
ALERT_KEY	4	Contains the identification number of the plant unit. It helps to identify the location (plant unit) of an event.	Unsigned 8	SRC	1	R/W			0
TARGET_MODE	5	Contains desired mode normally set by a control application or an operator.	Unsigned 8	SRC	1	R/W			-
MODE_BLK	6	Contains the current mode and the permitted and normal mode of the block.	DS-37	D	3	RO			128,152,8
ALARM_SUM	7	Contains the current states of the block alarms.	DS-42	D	8	RO			0:0:0:0
BATCH	8	Intended to be used in Batch applications in line with IEC61512 Part 1. Necessary in a distributed fieldbus system to identify used and available channels, in addition used to identify the current batch in case of alerts.	DS-67	SRC	10	R/W			0:0:0:0
OUT	10	Contains the current measurement value in a vendor-specific or configuration-adjusted engineering unit and the belonging state in AUTO MODE.	DS-33	D	5	RO **)			Measured of the variable state
PV_SCALE	11	Conversion of the Process Variable into percent using the high and low scale values. The engineering unit of PV_SCALE high and low scale values are directly related to the PV_UNIT of the configured Transducer Block (configured via Channel parameter). The PV_SCALE high and low scale values follow the changes of the PV_UNIT of the related Transducer Block automatically, i.e. a change of the Transducer Block PV_Unit causes no bump at OUT from AI.	2 * Float	SRC	8	R/W			100; 0
OUT_SCALE	12	Scale of the Process Variable. Contains the values of the lower limit and upper limit effective range, the code number of the engineering unit of Process Variable and the number of digits on the right hand side of the decimal point.	DS-36	SRC	11	R/W			100; 0; -; -
LIN_TYPE	13	Type of linearisation.	Unsigned 8	SRC	1	R/W			0
CHANNEL	14	Reference to the active Transducer Block which provides the measurement value to the Function Block.	Unsigned 16	SRC	2	R/W			1 : 281 2 : 283
PV_FTIME	16	Filter time of the Process Variable. Contains the time constant for the rise time of the FB output up to a value of 63.21% resulted from a jump on the input (PT1 filter). The engineering unit of the parameter is second.	Float	SRC	4	R/W			0
FSAFE_TYPE	17	Defines the reaction of the device if a fault is detected. The calculated ACTUAL MODE remains in AUTO.	Unsigned 8	SRC	1	R/W			1
FSAFE_VALUE	18	Default value for the OUT parameter, if sensor or sensor electronic fault is detected. The unit of this parameter is the same as the OUT unit.	Float	SRC	4	R/W			-
ALARM_HYS	19	Alarm hysteresis. To avoid triggering of many messages.	Float	SRC	4	R/W			0,5% of range
HI_HI_LIM	21	Value for the upper limit of alarms.	Float	SRC	4	R/W			Max value
HI_LIM	23	Value for the upper limit of warnings.	Float	SRC	4	R/W			Max value
LO_LIM	25	Value for the lower limit of warnings.	Float	SRC	4	R/W			Min value
LO_LO_LIM	27	Value for the lower limit of alarms.	Float	SRC	4	R/W			Min value
HI_HI_ALM	30	State of the upper limit of alarms.	DS-39	D	16	RO			0
HI_ALM	31	State of the upper limit of warnings.	DS-39	D	16	RO			0
LO_ALM	32	State of the lower limit of warnings.	DS-39	D	16	RO			0
LO_LO_ALM	33	State of the lower limit of alarms.	DS-39	D	16	RO			0
SIMULATE	34	For commissioning and test purposes the input value from the Transducer Block in the Analogue Input Function Block AI-FB can be modified. This means that the Transducer and AI-FB will be disconnected.	DS-50	SRC	6	R/W			Disabled
OUT_UNIT_TEXT	35	If a specific unit of OUT parameter is not in the code list the user has the possibility of writing the specific text in this parameter. The unit code is then equal to "textual unit definition".	Octet string	SRC	16	R/W			-

Head office

Denmark
PR electronics A/S
Lerbakken 10
DK-8410 Rønne

www.preelectronics.com
sales@preelectronics.dk
tel. +45 86 37 26 77
fax +45 86 37 30 85

Subsidiaries

France
PR electronics Sarl
Zac du Chêne, Activillage
2, allée des Sorbiers
F-69500 Bron

sales@preelectronics.fr
tel. +33 (0) 4 72 14 06 07
fax +33 (0) 4 72 37 88 20

Germany
PR electronics GmbH
Bamlerstraße 92
D-45141 Essen

sales@preelectronics.de
tel. +49 (0) 201 860 6660
fax +49 (0) 201 860 6666

Italy
PR electronics S.r.l.
Via Meli, 36
IT-20127 Milano

sales@preelectronics.it
tel. +39 02 2630 6259
fax +39 02 2630 6283

Spain
PR electronics S.L.
Avda. Meridiana 354, 6°-A
E-08027 Barcelona

sales@preelectronics.es
tel. +34 93 311 01 67
fax +34 93 311 08 17

Sweden
PR electronics AB
August Barks gata 6
S-421 32 Västra Frölunda

sales@preelectronics.se
tel. +46 (0) 3149 9990
fax +46 (0) 3149 1590

UK
PR electronics Ltd
20 Aubery Crescent, Largs
Ayrshire, KA30 8PR

sales@preelectronics.co.uk
tel. +44 (0) 1475 689 588
fax +44 (0) 1475 689 468

USA
PR electronics Inc.
16776 Bernardo Center Drive
Suite 203
San Diego, California 92128

sales@preelectronics.com
tel. +1 858 521 0167
fax +1 858 521 0945



Quality System
DS/EN ISO 9001

