



Displays Programmable displays with a wide selection of inputs and outputs for display of temperature, volume and weight, etc. Feature linearisation, scaling, and difference measurement functions for programming via PReset software.



Ex interfaces Interfaces for analogue and digital signals as well as HART® signals between sensors / I/P converters / frequency signals and control systems in Ex zone 0, 1 & 2 and for some modules in zone 20, 21 & 22.



Isolation Galvanic isolators for analogue and digital signals as well as HART® signals. A wide product range with both loop-powered and universal isolators featuring linearisation, inversion, and scaling of output signals.



Temperature A wide selection of transmitters for DIN form B mounting and DIN rail modules with analogue and digital bus communication ranging from application-specific to universal transmitters.



Universal PC or front programmable modules with universal options for input, output and supply. This range offers a number of advanced features such as process calibration, linearisation and auto-diagnostics.



- DK Side 1
- UK Page 13
- FR Page 25
- DE Seite 37



5 3 3 3

2-Wire Programmable Transmitter

No. 5333V110-IN (1008)
From ser. no. 080629052



SIGNALS THE BEST



Messtechnik Schaffhausen GmbH
CH-8260 Stein am Rhein
Telefon +41 52-672 50 00



Messen Prüfen Automatisieren www.mts.ch

2-TRÅDS PROGRAMMERBAR TRANSMITTER

PRetop 5333

Indholdsfortegnelse

EF-overensstemmelseserklæring	2
Anvendelse	3
Teknisk karakteristik	3
Montage / installation.....	3
Applikationer	4
Bestillingsskema: 5333	5
Elektriske specifikationer.....	5
Tilslutninger	8
Blokdiagram	9
Programmering.....	10
Mekaniske specifikationer.....	11
Montering af følerledninger	11
Appendix	48
ATEX Installation Drawings - 5333A, UK, FR, DE, DK.....	49
ATEX Installation Drawings - 5333D, UK, FR, DE, DK.....	53
FM Installation Drawing No. 5300Q502	61
CSA Installation Drawing No. 533XQC03	63

EF-OVERENSSTEMMELSESERKLÆRING

Som producent erklærer

PR electronics A/S
Lerbakken 10
DK-8410 Rønde

hermed at følgende produkt:

Type: 5333
Navn: 2-Tråds programmerbar transmitter

er i overensstemmelse med følgende direktiver og standarder:

EMC-direktivet 2004/108/EF og senere tilføjelser

EN 61326-1 : 2006

For specifikation af det acceptable EMC-niveau henvises til modulets elektriske specifikationer.

ATEX-direktivet 94/9/EF og senere tilføjelser

EN 60079-0 : 2006, EN 60079-11 : 2007,
EN 60079-15 : 2005 og EN 60079-26 : 2007
EN 61241-0 : 2006 og EN 61241-11 : 2006
ATEX-certifikat: KEMA 10ATEX0003 X (5333A)
ATEX-certifikat: KEMA 03ATEX1535 (5333D)

Bemyndiget organ

KEMA Quality B.V. (0344)
Utrechtseweg 310, 6812 AR Arnhem
P.O. Box 5185, 6802 ED Arnhem
The Netherlands



Kim Rasmussen
Producentens underskrift

Rønde, 10. februar 2010

2-TRÅDS PROGRAMMERBAR TRANSMITTER PRetop 5333

- *Indgang for RTD eller Ohm*
- *Høj målenøjagtighed*
- *3-leder tilslutning*
- *Programmerbar følerfejlsværdi*
- *Kan monteres i DIN form B følerhoved*

Anvendelse

- Temperaturlineariseret måling med Pt100...Pt1000 eller Ni100...Ni1000 føler.
- Omsætning af lineær modstandsændring til standard analogt strømsignal, f.eks. fra ventiler eller ohmske niveaustave.

Teknisk karakteristik

- PR5333 kan af brugeren i løbet af få sekunder programmeres til at måle inden for alle normerede RTD-temperaturområder.
- RTD- og modstandsindgangen har kabelkompensering for 3-leder tilslutning.

Montage / installation

- Kan monteres i DIN form B følerhoved. I ikke-eksplosionsfarlige områder kan 5333 monteres på en DIN-skinne med et specielt beslag.
- **NB:** Som Ex-barriere for 5333D anbefaler vi 5104B, 5114B eller 5116B.

APPLIKATIONER

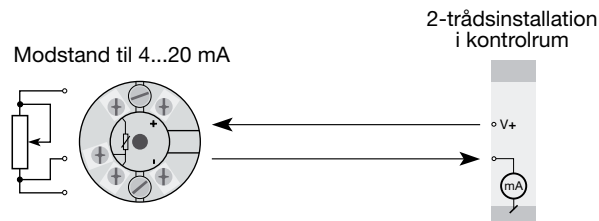
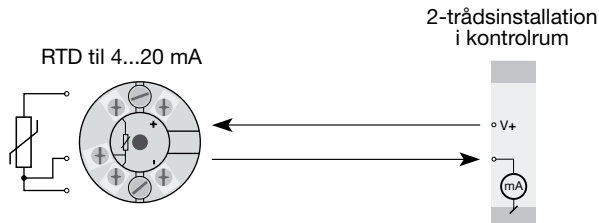

Bestillingsskema: 5333

Type	Version
5333	Standard : A CSA, FM & ATEX : D

Elektriske specifikationer

Specifikationsområde:

-40°C til +85°C

Fælles specifikationer:

Forsyningsspænding DC

Standard.....	8...35 V
CSA, FM & ATEX.....	8...30 V
Egefforbrug.....	25 mW...0,8 W
Spændingsdrop.....	8 VDC
Opvarmningstid.....	5 min.
Kommunikationsinterface.....	Loop Link
Signal- / støjforhold.....	Min. 60 dB
Reaktionstid (programmerbar)	0,33...60 s
Signaldynamik, indgang.....	19 bit
Signaldynamik, udgang.....	16 bit
Kalibreringstemperatur.....	20...28°C

Nøjagtighed, størst af generelle og basisværdier:

Generelle værdier		
Indgangstype	Absolut nøjagtighed	Temperaturkoefficient
Alle	$\leq \pm 0,1\%$ af span	$\leq \pm 0,01\%$ af span / °C

Basisværdier		
Indgangstype	Basisnøjagtighed	Temperaturkoefficient
RTD	$\leq \pm 0,3^\circ\text{C}$	$\leq \pm 0,01^\circ\text{C}/^\circ\text{C}$
Lin. R	$\leq \pm 0,2 \Omega$	$\leq \pm 20 \text{ m}\Omega / ^\circ\text{C}$

EMC-immunitetspåvirkning.....	$< \pm 0,5\%$ af span
-------------------------------	-----------------------

Virkning af forsyningsspændings-ændring	≤ 0,005% af span / VDC
Vibration	IEC 60068-2-6 Test FC
Lloyd's specifikation nr. 1	4 g / 2...100 Hz
Max. ledningskvadrat	1 x 1,5 mm ² flerkeret ledning
Luffugtighed	< 95% RH (ikke kond.)
Mål.....	Ø 44 x 20,2 mm
Kapslingsklasse (hus / klemme).....	IP68 / IP00
Vægt.....	50 g

Elektriske specifikationer indgang:

RTD- og lineær modstandsindgang:

RTD-type	Min. værdi	Max. værdi	Min. span	Standard
Pt100	-200°C	+850°C	25°C	IEC 60751
Ni100	-60°C	+250°C	25°C	DIN 43760
Lin. R	0 Ω	10000 Ω	30 Ω	-----

Max. nulpunktsforskydning (offset)	50% af valgt max. værdi
Kabelmodstand pr. leder (max.)	10 Ω
Følerstrøm	> 0,2 mA, < 0,4 mA
Virkning af følerkabelmodstand (3-leder)	< 0,002 Ω / Ω
Følerfejlsdetektering	Ja

Udgang:

Strømdugang:

Signalområde	4...20 mA
Min. signalområde	16 mA
Opdateringstid	135 ms
Belastningsmodstand	≤ (V _{forsyn} - 8) / 0,023 [Ω]
Belastningsstabilitet	< ±0,01% af span / 100 Ω

Følerfejlsdetektering:

Programmerbar	3,5...23 mA
NAMUR NE43 Upscale	23 mA
NAMUR NE43 Downscale	3,5 mA

Af span = Af det aktuelt valgte område

Ex-godkendelse - 5333A:

KEMA 10ATEX0003 X.....	II 3 GD Ex nA [nL] IIC T4...T6 eller II 3 GD Ex nL IIC T4...T6 eller II 3 GD Ex nA [ic] IIC T4...T6 eller II 3 GD Ex ic IIC T4...T6
ATEX Installation Drawing No.....	5333QA02

Ex- / I.S.-godkendelse - 5333D:

KEMA 03ATEX1535.....	II 1 G Ex ia IIC T4 eller T6 II 1 D Ex iaD
Max. omgivelsestemp. for T4.....	85°C
Max. omgivelsestemp. for T6	60°C
ATEX, må anvendes i zone.....	0, 1, 2, 20, 21 eller 22
ATEX Installation Drawing No.	5333QA01
FM, må anvendes i.....	IS, Class I, Div. 1, Group A, B, C, D IS, Class I, Zone 0, AEx ia IIC
FM Installation Drawing No.....	5300Q502
CSA, må anvendes i.....	IS, Class I, Div. 1, Group A, B, C, D, Ex ia IIC
CSA Installation Drawing No.	IS, Class I, Zone 0, AEx ia IIC 5333QC03

Marine-godkendelse:

Det Norske Veritas, Ships & Offshore	Standard for Certification No. 2.4
--	------------------------------------

GOST R godkendelse:

VNIIM & VNIIFTRI, Cert. no.....	Se www.prelectronics.dk
---------------------------------	-------------------------

Overholdte myndighedskrav:

EMC 2004/108/EF	EN 61326-1
ATEX 94/9/EF	EN 60079-0, EN 60079-11, EN 60079-15, EN 60079-26, EN 61241-0, EN 61241-11
FM	3600, 3611, 3610
CSA, CAN / CSA	C22.2 No. 157, E60079-11, UL 913

Standard:

TILSLUTNINGER

Indgang:

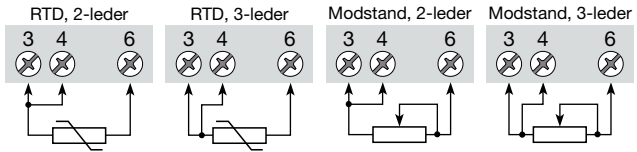

Udgang:

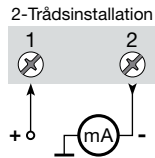

BLOKDIAGRAM

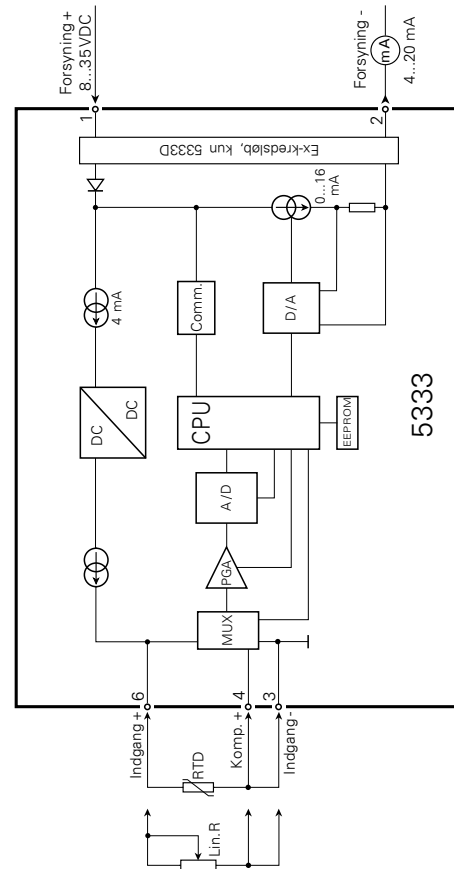

PROGRAMMERING

- Loop Link er et batteridrevet kommunikationsinterface, der er nødvendigt for programmering af PRetop 5333.
- Ved programmering henvises til tegningen nedenfor og hjælpefunktionen i PReset programmet.
- Loop Link må ikke benyttes til kommunikation med moduler installeret i Ex-område.

Bestilling: Loop Link

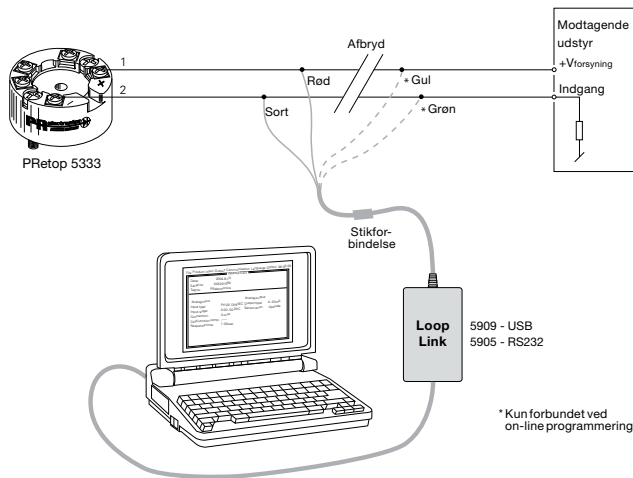

Mekaniske specifikationer

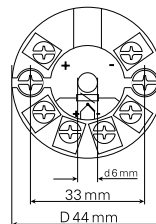

Montering af følerledninger

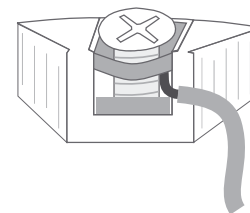

Ledninger monteres mellem metalpladerne

2-WIRE PROGRAMMABLE TRANSMITTER

PRetop 5333

Contents

EC declaration of conformity	14
Application	15
Technical characteristics	15
Mounting / installation.....	15
Applications.....	16
Order: 5333	17
Electrical specifications.....	17
Connections	20
Block diagram	21
Programming.....	22
Mechanical specifications.....	23
Mounting of sensor wires.....	23
Appendix	48
ATEX Installation Drawings - 5333A, UK, FR, DE, DK.....	49
ATEX Installation Drawings - 5333D, UK, FR, DE, DK.....	53
FM Installation Drawing No. 5300Q502.....	61
CSA Installation Drawing No. 533XQC03.....	63

EC DECLARATION OF CONFORMITY

As manufacturer

PR electronics A/S
Lerbakken 10
DK-8410 Rønde

hererby declares that the following product:

Type: 5333
Name: 2-Wire programmable transmitter

is in conformity with the following directives and standards:

The EMC Directive 2004/108/EC and later amendments

EN 61326-1 : 2006

For specification of the acceptable EMC performance level, refer to the electrical specifications for the module.

The ATEX Directive 94/9/EC and later amendments

EN 60079-0 : 2006, EN 60079-11 : 2007,
EN 60079-15 : 2005 and EN 60079-26 : 2007
EN 61241-0 : 2006 and EN 61241-11 : 2006
ATEX certificate: KEMA 10ATEX0003 X (5333A)
ATEX certificate: KEMA 03ATEX1535 (5333D)

Notified body

KEMA Quality B.V. (0344)
Utrechtseweg 310, 6812 AR Arnhem
P.O. Box 5185, 6802 ED Arnhem
The Netherlands



Kim Rasmussen
Manufacturer's signature

Rønde, 10 February 2010

2-WIRE PROGRAMMABLE TRANSMITTER PRetop 5333

- *RTD or Ohm input*
- *High measurement accuracy*
- *3-wire connection*
- *Programmable sensor error value*
- *For DIN form B sensor head mounting*

Application

- Linearised temperature measurement with Pt100...Pt1000 or Ni100...Ni1000 sensor.
- Conversion of linear resistance variation to a standard analogue current signal, for instance from valves or Ohmic level sensors.

Technical characteristics

- Within a few seconds the user can program PR5333 to measure temperatures within all RTD ranges defined by the norms.
- The RTD and resistance inputs have cable compensation for 3-wire connection.

Mounting / installation

- For DIN form B sensor head mounting. In non-hazardous areas the 5333 can be mounted on a DIN rail with a special fitting.
- **NB:** As Ex barrier for 5333D we recommend 5104B, 5114B, or 5116B.

APPLICATIONS

RTD to 4...20 mA

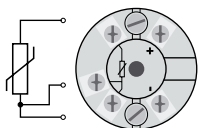

2-wire installation
in control room

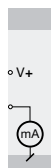

Resistance to 4...20 mA

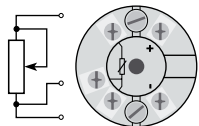

2-wire installation
in control room

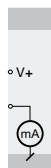

Order: 5333

Type	Version
53333	Standard : A CSA, FM & ATEX : D

Electrical specifications

Specifications range:

-40°C to +85°C

Common specifications:

Supply voltage, DC

Standard..... 8...35 V

CSA, FM & ATEX..... 8...30 V

Internal consumption 25 mW...0.8 W

Voltage drop 8 VDC

Warm-up time..... 5 min.

Communications interface Loop Link

Signal / noise ratio Min. 60 dB

Response time (programmable)..... 0.33...60 s

Signal dynamics, input..... 19 bit

Signal dynamics, output..... 16 bit

Calibration temperature..... 20...28°C

Accuracy, the greater of general and basic values:

General values		
Input type	Absolute accuracy	Temperature coefficient
All	≤ ±0.1% of span	≤ ±0.01% of span / °C

Basic values		
Input type	Basic accuracy	Temperature coefficient
RTD	≤ ±0.3°C	≤ ±0.01°C/°C
Lin. R	≤ ±0.2 Ω	≤ ±20 mΩ / °C

EMC immunity influence	< ±0.5% of span
------------------------------	-----------------

Effect of supply voltage variation..... ≤ 0,005% of span / VDC
 Vibration IEC 60068-2-6 Test FC
 Lloyd's specification no. 1..... 4 g / 2...100 Hz
 Max. wire size..... 1 x 1.5 mm² stranded wire
 Humidity < 95% RH (non-cond.)
 Dimensions..... Ø 44 x 20.2 mm
 Protection degree (enclosure / terminal)..... IP68 / IP00
 Weight 50 g

Electrical specifications, input:

RTD and linear resistance input:

RTD type	Min. value	Max. value	Min. span	Standard
Pt100	-200°C	+850°C	25°C	IEC 60751
Ni100	-60°C	+250°C	25°C	DIN 43760
Lin. R	0 Ω	10000 Ω	30 Ω	-----

Max. offset..... 50% of selec. max. value
 Cable resistance per wire (max.)..... 10 Ω
 Sensor current..... > 0.2 mA, < 0.4 mA
 Effect of sensor cable resistance
 (3-wire)..... < 0.002 Ω / Ω
 Sensor error detection Yes

Output:

Current output:

Signal range 4...20 mA
 Min. signal range..... 16 mA
 Updating time..... 135 ms
 Load resistance..... ≤ (V_{supply} - 8) / 0.023 [Ω]
 Load stability < ±0.01% of span / 100 Ω

Sensor error detection:

Programmable..... 3.5...23 mA
 NAMUR NE43 Upscale 23 mA
 NAMUR NE43 Downscale..... 3.5 mA

Of span = Of the presently selected range

Ex approval - 5333A:

KEMA 10ATEX0003 X.....  II 3 GD Ex nA [nL] IIC T4...T6 or
 II 3 GD Ex nL IIC T4...T6 or
 II 3 GD Ex nA [ic] IIC T4...T6 or
 II 3 GD Ex ic IIC T4...T6
 ATEX Installation Drawing No..... 5333QA02

Ex / I.S. approval - 5333D:

KEMA 03ATEX1535.....  II 1 G Ex ia IIC T4 or T6
 II 1 D Ex iaD
 Max. amb. temperature for T4 85°C
 Max. amb. temperature for T6 60°C
 ATEX, applicable in zone..... 0, 1, 2, 20, 21 or 22
 ATEX Installation Drawing No. 5333QA01

FM, applicable in..... IS, Class I, Div. 1, Group A, B, C, D
 IS, Class I, Zone 0, AEx ia IIC
 FM Installation Drawing No..... 5300Q502

CSA, applicable in..... IS, Class I, Div. 1, Group A, B, C, D,
 Ex ia IIC
 IS, Class I, Zone 0, AEx ia IIC
 CSA Installation Drawing No. 533XQC03

Marine approval:

Det Norske Veritas, Ships & Offshore Standard for Certification No. 2.4

GOST R approval:

VNIIM & VNIIFTRI, Cert. no..... See www.prelectronics.com

Observed authority requirements:

EMC 2004/108/EC EN 61326-1
 ATEX 94/9/EC..... EN 60079-0, EN 60079-11,
 EN 60079-15, EN 60079-26,
 EN 61241-0, EN 61241-11
 FM 3600, 3611, 3610
 CSA, CAN / CSA C22.2 No. 157, E60079-11, UL 913

Standard:

CONNECTIONS

Input:

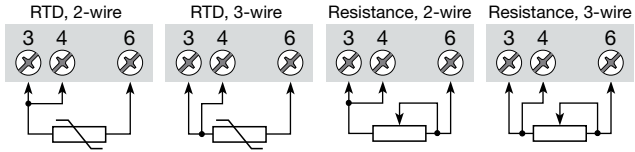

Output:

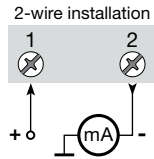

BLOCK DIAGRAM

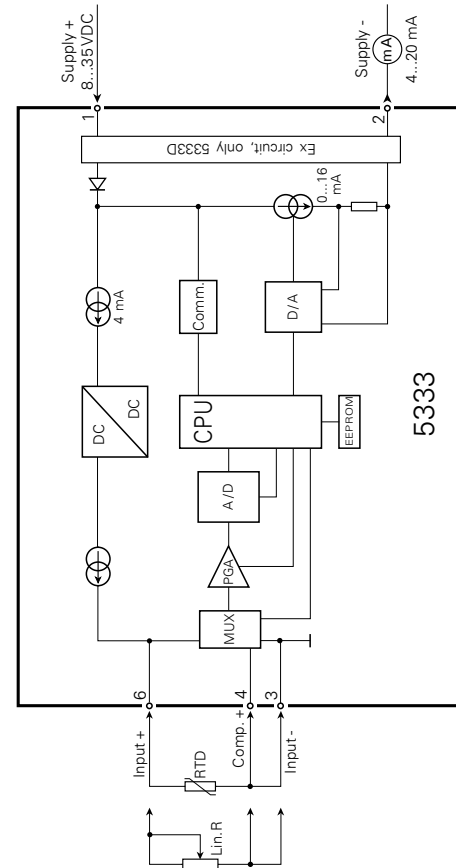

PROGRAMMING

- Loop Link is a communications interface that is needed for programming PRetop 5333.
- For programming please refer to the drawing below and the help functions in PReset.
- Loop Link is not approved for communication with modules installed in hazardous (Ex) areas.

Order: Loop Link

Mechanical specifications

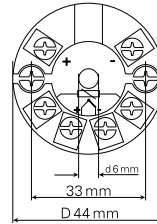

Mounting of sensor wires

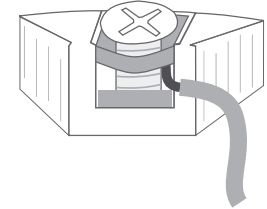

Wires must be mounted between the metal plates.

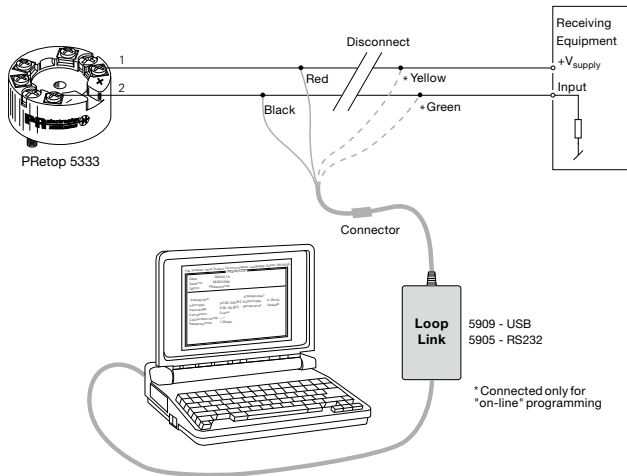

TRANSMETTEUR 2-FILS PROGRAMMABLE (Pt100)

PRetop 5333

Sommaire

Déclaration de conformité CE.....	26
Application	27
Caractéristiques techniques.....	27
Montage / installation.....	27
Applications.....	28
Référence : 5333.....	29
Spécifications.....	29
Connexions	32
Schéma de principe	33
Programmation.....	34
Dimensions mécaniques	34
Montage des fils du capteur	35
Appendix	48
ATEX Installation Drawings - 5333A, UK, FR, DE, DK.....	49
ATEX Installation Drawings - 5333D, UK, FR, DE, DK.....	53
FM Installation Drawing No. 5300Q502.....	61
CSA Installation Drawing No. 533XQC03.....	63

DECLARATION DE CONFORMITE CE

En tant que fabricant

PR electronics A/S
Lerbakken 10
DK-8410 Rønde

déclare que le produit suivant :

Type : 5333

Nom : Transmetteur 2-fils programmable

correspond aux directives et normes suivantes :

La directive CEM (EMC) 2004/108/CE et les modifications subséquentes

EN 61326-1 : 2006

Pour une spécification du niveau de rendement acceptable CEM (EMC)
renvoyer aux spécifications électriques du module.

La directive ATEX 94/9/CE et les modifications subséquentes

EN 60079-0 : 2006, EN 60079-11 : 2007,

EN 60079-15 : 2005 et EN 60079-26 : 2007

EN 61241-0 : 2006 et EN 61241-11 : 2006

Certificat ATEX : KEMA 10ATEX0003 X (5333A)

Certificat ATEX : KEMA 03ATEX1535 (5333D)

Organisme notifié

KEMA Quality B.V. (0344)
Utrechtseweg 310, 6812 AR Arnhem
P.O. Box 5185, 6802 ED Arnhem
The Netherlands



Kim Rasmussen
Signature du fabricant

Rønde, le 10 février 2010

TRANSMETTEUR 2-FILS PROGRAMMABLE (Pt100) PRetop 5333

- *Entrée RTD ou résistance*
- *Grande précision de mesure*
- *Connexion aux sondes à 3 fils*
- *Sécurité programmable*
- *Pour tête de sonde DIN B*

Application

- Mesure linéarisée de la température avec un capteur Pt100...Pt1000 ou Ni100...Ni1000.
- Conversion d'une résistance linéaire en un signal courant standard analogique pour mesurer par exemple le niveau ou la position d'une vanne.

Caractéristiques techniques

- Le PR5333 peut être programmé de manière simple et rapide.
- Compensation de ligne pour des entrées RTD et résistance avec un raccordement à 3 fils.

Montage / installation

- Pour tête de sonde DIN B. En zone non-dangereuse le 5333 peut être monté sur rail DIN avec un support spécifique.
- **N.B.** : Comme barrière S.I. pour le 5333D nous recommandons le PR5104B, 5114B ou 5116B.

APPLICATIONS

RTD en 4...20 mA

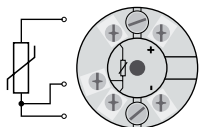

Installation 2-fils
en salle de contrôle

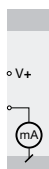

Résistance en 4...20 mA

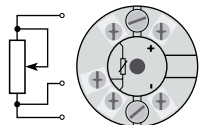

Installation 2-fils
en salle de contrôle

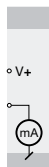

Référence : 5333

Type	Version
5333	Standard : A CSA, FM & ATEX : D

Spécifications

Plage de température:

-40°C à +85°C

Spécifications communes:

Tension d'alimentation cc

Standard..... 8...35 V

CSA, FM & ATEX..... 8...30 V

Consommation interne..... 25 mW...0,8 W

Chute de tension..... 8 Vcc

Temps de chauffe..... 5 min.

Kit de programmation Loop Link

Rapport signal / bruit Min. 60 dB

Temps de réponse (programmable) 0,33...60 s

Dynamique du signal d'entrée 19 bit

Dynamique du signal de sortie 16 bit

Température d'étalonnage 20...28°C

Précision, la plus grande des valeurs générales et de base:

Valeurs générales		
Type d'entrée	Précision absolue	Coefficient de température
Tous	≤ ±0,1% de l'EC	≤ ±0,01% de l'EC / °C

Valeurs de base		
Type d'entrée	Précision de base	Coefficient de température
RTD	≤ ±0,3°C	≤ ±0,01°C/°C
Résist. linéaire	≤ ±0,2 Ω	≤ ±20 mΩ / °C

Immunité CEM.....	< ±0,5% de l'EC
-------------------	-----------------

Effet d'une variation de la tension d'alimentation $\leq 0,005\%$ de l'EC / Vcc
 Vibration IEC 60068-2-6 Test FC
 Lloyd, spécification no 1 4 g / 2...100 Hz
 Taille max. des fils 1 x 1,5 mm² fil multibrins
 Humidité $< 95\%$ HR (sans cond.)
 Dimensions $\varnothing 44 \times 20,2$ mm
 Degré de protection (boîtier / bornier) IP68 / IP00
 Poids 50 g

Spécifications électriques, entrée :

Entrée RTD et entrée résistance linéaire :

Type RTD	Valeur min.	Valeur max.	Plage min.	Standard
Pt100	-200°C	+850°C	25°C	IEC 60751
Ni100	-60°C	+250°C	25°C	DIN 43760
R lin.	0 Ω	10000 Ω	30 Ω	-----

Décalage max. 50% de la valeur max. sélectionnée
 Résistance de ligne max. par fil 10 Ω
 Courant de sonde $> 0,2$ mA, $< 0,4$ mA
 Effet de la résistance de ligne (3-fils) $< 0,002$ Ω / Ω
 Détection de rupture sonde Oui

Sortie :

Sortie courant :

Gamme de mesure 4...20 mA
 Plage de mesure min. 16 mA
 Temps de scrutation 135 ms
 Résistance de charge $\leq (V_{alim.} - 8) / 0,023$ [Ω]
 Stabilité de charge $< \pm 0,01\%$ de l'EC / 100 Ω

Détection de rupture de sonde :

Programmable 3,5...23 mA
 NAMUR NE43 Haut d'échelle 23 mA
 NAMUR NE43 Bas d'échelle 3,5 mA

EC = Echelle configurée

Approbation Ex - 5333A:

KEMA 10ATEX0003 X  II 3 GD Ex nA [nL] IIC T4...T6 ou
 II 3 GD Ex nL IIC T4...T6 ou
 II 3 GD Ex nA [ic] IIC T4...T6 ou
 II 3 GD Ex ic IIC T4...T6
 ATEX Installation Drawing No. 5333QA02

Approbation Ex / S.I. - 5333D:

KEMA 03ATEX1535  II 1 G Ex ia IIC T4 ou T6
 II 1 D Ex iaD
 Température ambiante max. (T4) 85°C
 Température ambiante max. (T6) 60°C
 ATEX, applicable en zone 0, 1, 2, 20, 21 ou 22
 ATEX Installation Drawing No. 5333QA01

FM, applicable en IS, Class I, Div. 1, Group A, B, C, D
 IS, Class I, Zone 0, AEx ia IIC
 FM Installation Drawing No. 5300Q502

CSA, applicable en IS, Class I, Div. 1, Group A, B, C, D,
 Ex ia IIC
 IS, Class I, Zone 0, AEx ia IIC
 CSA Installation Drawing No. 533XQC03

Approbation marine:

Det Norske Veritas, Ships & Offshore Standard for Certification No. 2.4

Approbation GOST R :

VNIIM & VNIIFTRI, Cert. no. Voir www.prelectronics.fr

Agréments et homologations :

Standard :
 CEM 2004/108/CE EN 61326-1
 ATEX 94/9/CE EN 60079-0, EN 60079-11,
 EN 60079-15, EN 60079-26,
 EN 61241-0, EN 61241-11
 FM 3600, 3611, 3610
 CSA, CAN / CSA C22.2 No. 157, E60079-11, UL 913

CONNEXIONS

Entrée :

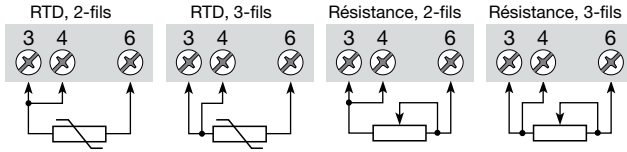

Sortie :

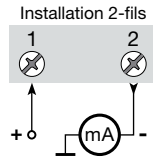

SCHEMA DE PRINCIPE

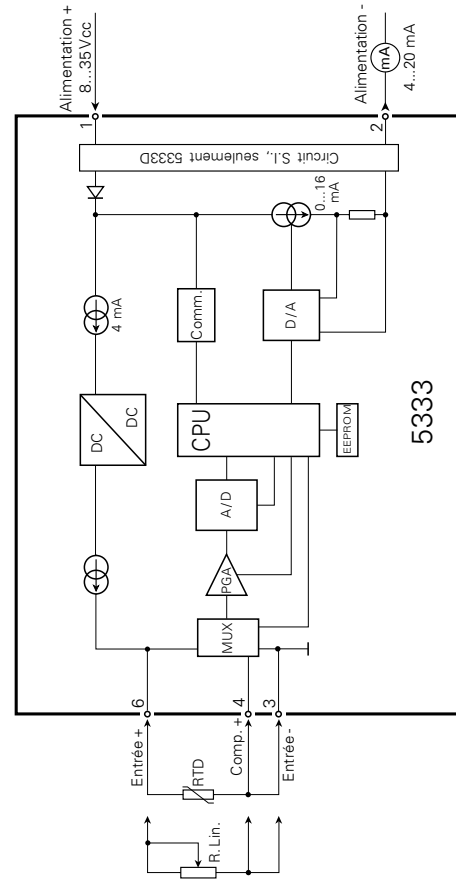

PROGRAMMATION

- Loop Link est un kit de programmation permettant de programmer le PRetop 5333.
- Pour le raccordement du Loop Link, veuillez vous reporter au schéma ci-dessous et à l'aide en ligne du logiciel PReset.
- Loop Link ne doit pas être utilisé pour communication avec des modules installés en zone dangereuse.

Numéro de référence : Loop Link

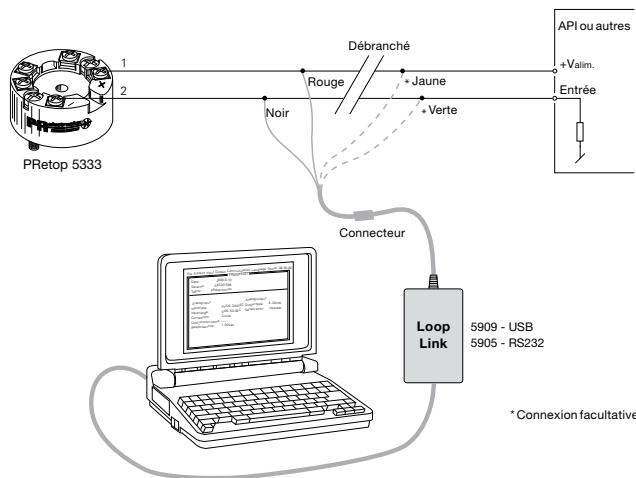

Dimensions mécaniques

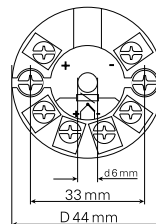

Montage des fils du capteur

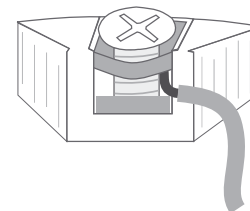

Les fils doivent être montés entre les plaques métalliques.

2-DRAHT PROGRAMMIERBARER MESSUMFORMER

PRetop 5333

Inhaltsverzeichnis

EG-Konformitätserklärung.....	38
Verwendung.....	39
Technische Merkmale.....	39
Montage / Installation.....	39
Anwendungen	40
Bestellangaben: 5333.....	41
Anschlüsse	44
Blockdiagramm	45
Programmierung.....	46
Abmessungen	47
Montage von Fühlerleitungen:.....	47
Appendix	48
ATEX Installation Drawings - 5333A, UK, FR, DE, DK.....	49
ATEX Installation Drawings - 5333D, UK, FR, DE, DK.....	53
FM Installation Drawing No. 5300Q502	61
CSA Installation Drawing No. 533XQC03	63

EG-KONFORMITÄTSERKLÄRUNG

Als Hersteller bescheinigt

PR electronics A/S
Lerbakken 10
DK-8410 Rønde

hiermit für das folgende Produkt:

Typ: 5333

Name: 2-Draht programmierbarer Messumformer

die Konformität mit folgenden Richtlinien und Normen:

Die EMV Richtlinien 2004/108/EG und nachfolgende Änderungen

EN 61326-1 : 2006

Zur Spezifikation des zulässigen Erfüllungsgrades, siehe die Elektrische Daten des Moduls.

Die ATEX Richtlinien 94/9/EG und nachfolgende Änderungen

EN 60079-0 : 2006, EN 60079-11 : 2007,

EN 60079-15 : 2005 und EN 60079-26 : 2007

EN 61241-0 : 2006 und EN 61241-11 : 2006

ATEX-Zertifikat: KEMA 10ATEX0003 X (5333A)

ATEX-Zertifikat: KEMA 03ATEX1535 (5333D)

Zulassungsstelle

KEMA Quality B.V. (0344)
Utrechtseweg 310, 6812 AR Arnhem
P.O. Box 5185, 6802 ED Arnhem
The Netherlands



Kim Rasmussen
Unterschrift des Herstellers

Rønde, 10. Februar 2010

2-DRAHT PROGRAMMIERBARER MESSUMFORMER PRetop 5333

- *Eingang für WTH oder Ω*
- *Hohe Messgenauigkeit*
- *3-Leiter-Anschluss*
- *Programmierbare Sensorfehlanzeige*
- *Für Einbau in Anschlusskopf DIN Form B*

Verwendung

- Linearisierte Temperaturmessung mit Pt100...Pt1000, Ni100...Ni1000 Sensor.
- Umwandlung von linearer Widerstandsänderung in ein analoges Standard-Stromsignal, z.B. von Ventilen oder Niveau-Messwertgeber.

Technische Merkmale

- PR5333 kann vom Benutzer innerhalb von wenigen Sekunden zur Messung in allen genormten WTH-Temperaturbereiche programmiert werden.
- Der WTH- und Widerstandseingang haben Leitungskompensation bei 3-Leiter-Anschluss.

Montage / Installation

- Für DIN Form B Sensorkopf Montage. Im sicheren Bereich kann der 5333 auf einer DIN-Schiene mittels einer spezieller Armatur montiert werden.
- **NB:** Als Ex-Sicherheitsbarriere für 5333D empfehlen wir 5104B, 5114B oder 5116B.

ANWENDUNGEN

WTH in 4...20 mA

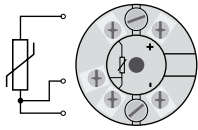

2-Draht-Installation
im Kontrollraum

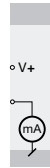

Widerstand in 4...20 mA

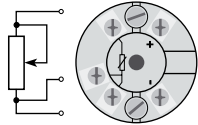

2-Draht-Installation
im Kontrollraum

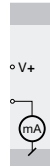

Bestellangaben: 5333

Typ	Version
5333	Standard : A CSA, FM & ATEX : D

Elektrische Daten:

Spezifikationsbereich:

-40°C bis +85°C

Gemeinsame Daten:

Versorgungsspannung DC

Standard.....	8...35 V
CSA, FM & ATEX.....	8...30 V
Eigenverbrauch	25 mW...0,8 W
Spannungsabfall.....	8 VDC
Aufwärmzeit.....	5 Min.
Kommunikationsschnittstelle	Loop Link
Signal- / Rauschverhältnis	Min. 60 dB
Ansprechzeit (programmierbar).....	0,33...60 s
Signaldynamik, Eingang.....	19 Bit
Signaldynamik, Ausgang.....	16 Bit
Kalibrierungstemperatur.....	20...28 °C

Genauigkeit, höherer Wert von allgemeinen und Grundwerten:

Allgemeine Werte		
Eingangsart	Absolute Genauigkeit	Temperaturkoeffizient
Alle	≤ ±0,1% d. Messsp.	≤ ±0,01% d. Messsp./°C

Grundwerte		
Eingangsart	Grund-Genauigkeit	Temperaturkoeffizient
WTH	≤ ±0,3°C	≤ ±0,01°C/°C
Lin. R	≤ ±0,2 Ω	≤ ±20 mΩ / °C

EMV-Immunitätseinwirkung..... < ±0,5% d. Messsp.

Einfluss von Änderung der Versorgungsspannung..... ≤ 0,005% d. Messsp. / VDC
 Vibration IEC 60068-2-6 Test FC
 Lloyd's Spezifikation Nr. 1 4 g / 2..100 Hz
 Max. Leitungsquerschnitt..... 1 x 1,5 mm² Litzendraht
 Luftfeuchtigkeit..... < 95% RF (nicht kond.)
 Maß Ø 44 x 20,2 mm
 Schutzart (Gehäuse / Anschluss)..... IP68 / IP00
 Gewicht 50 g

Elektrische Daten, Eingang:

WTH- und linearer Widerstandseingang:

WTH-Typ	Min. Wert	Max. Wert	Min. Spanne	Norm
Pt100	-200°C	+850°C	25°C	IEC 60751
Ni100	-60°C	+250°C	25°C	DIN 43760
Lin. R	0 Ω	10000 Ω	30 Ω	-----

Max. Nullpunktverschiebung (Offset)..... 50% des gewählten Max.-Wertes
 Leitungswiderstand pro Leiter (Max.)..... 10 Ω
 Fühlerstrom > 0,2 mA, < 0,4 mA
 Wirkung des Fühlerkabelwiderstandes (3-Leiter) < 0,002 Ω / Ω
 Fühlerfehlererkennung..... Ja

Ausgang:

Stromausgang:

Signalbereich..... 4..20 mA
 Min. Signalbereich..... 16 mA
 Aktualisierungszeit..... 135 ms
 Belastungswiderstand..... ≤ (U_{vers.} - 8) / 0,023 [Ω]
 Belastungsstabilität < ±0,01% d. Messsp. / 100 Ω

Fühlerfehlererkennung:

Programmierbar..... 3,5..23 mA
 NAMUR NE43 aufsteuernd 23 mA
 NAMUR NE43 zusteuernd..... 3,5 mA

d. Messspanne = der gewählten Messspanne

Ex-Zulassung - 5333A:

KEMA 10ATEX0003 X.....  II 3 GD Ex nA [nL] IIC T4...T6 oder
 II 3 GD Ex nL IIC T4...T6 oder
 II 3 GD Ex nA [ic] IIC T4...T6 oder
 II 3 GD Ex ic IIC T4...T6
 ATEX Installation Drawing No..... 5333QA02

Ex- / I.S.-Zulassung - 5333D:

KEMA 03ATEX1535.....  II 1 G Ex ia IIC T4 oder T6
 II 1 D Ex iaD
 Max. Umgebungstemp. für T4 85°C
 Max. Umgebungstemp. für T6 60°C
 ATEX,für Anwendung in Zone 0, 1, 2, 20, 21 oder 22
 ATEX Installation Drawing No. 5333QA01

FM, für Anwendung in..... IS, Class I, Div. 1, Group A, B, C, D
 IS, Class I, Zone 0, AEx ia IIC
 FM Installation Drawing No..... 5300Q502

CSA, für Anwendung in..... IS, Class I, Div. 1, Group A, B, C, D,
 Ex ia IIC
 IS, Class I, Zone 0, AEx ia IIC
 CSA Installation Drawing No. 533XQC03

Marine-Zulassung:

Det Norske Veritas, Ships & Offshore Standard for Certification No. 2.4

GOST R Zulassung:

VNIIM & VNIIFTRI, Cert. no..... Siehe www.prelectronics.de

Eingehaltene Richtlinien:

EMV 2004/108/EG..... EN 61326-1
 ATEX 94/9/EG..... EN 60079-0, EN 60079-11,
 EN 60079-15, EN 60079-26,
 EN 61241-0, EN 61241-11
 FM 3600, 3611, 3610
 CSA, CAN / CSA C22.2 No. 157, E60079-11, UL 913

Norm:

ANSCHLÜSSE

Eingang:

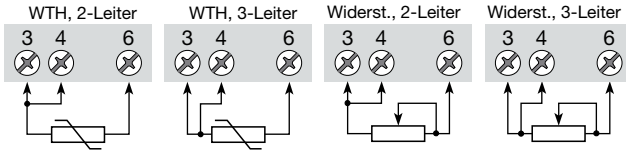

Ausgang:

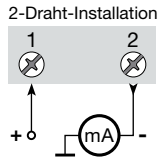

BLOCKDIAGRAMM

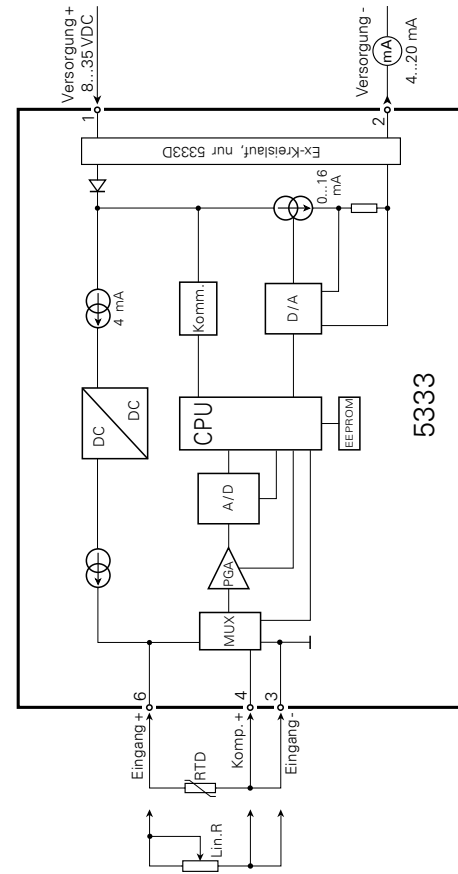

PROGRAMMIERUNG

- Loop Link ist eine batteriegespeiste Schnittstelle zur Programmierung des PRetop 5333.
- Bezüglich Programmierung verweisen wir auf die nachfolgende Zeichnung und die "Hilfe"-Funktion im PReset-Programm.
- Loop Link darf nicht zur Kommunikation mit Modulen, die in Ex-gefährdeten Bereichen installiert sind, benutzt werden.

Bestellangaben: Loop Link

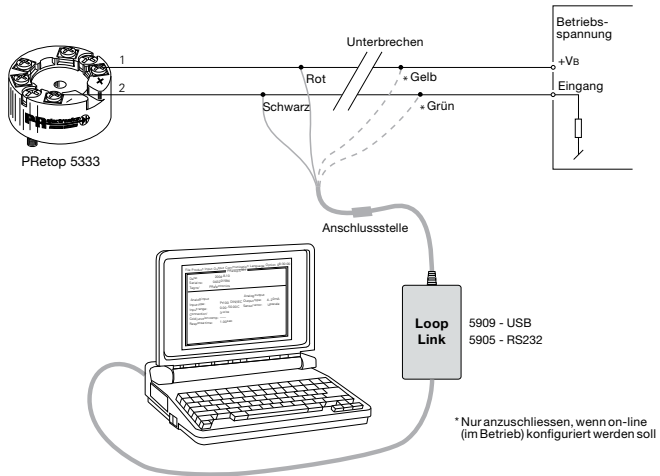

Abmessungen

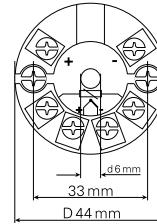

Montage von Fühlerleitungen:

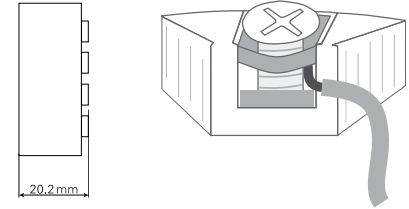

Die Leitungen müssen zwischen den Metallplatten montiert werden.

APPENDIX

ATEX Installation drawing

For safe installation of 5333A the following must be observed. The module shall only be installed by qualified personnel who are familiar with the national and international laws, directives and standards that apply to this area.
Year of manufacture can be taken from the first two digits in the serial number.

ATEX INSTALLATION DRAWINGS - 5333A UK, FR, DE, DK

ATEX INSTALLATION DRAWINGS - 5333D UK, FR, DE, DK

FM INSTALLATION DRAWING NO. 5300Q502

CSA INSTALLATION DRAWING NO. 533XQC03

ATEX Certificate KEMA 10ATEX0003 X

Marking  II 3 GD Ex nA [nL] IIC T6...T4
II 3 GD Ex nL IIC T6...T4

II 3 GD Ex nA [c] IIC T6...T4
II 3 GD Ex ic IIC T6...T4

Standards EN 60079-0 : 2006, EN 60079-11 : 2007, EN 60079-15 : 2005

T4: $-40 \leq T_a \leq 85^\circ\text{C}$ Terminal: 3,4,6
T6: $-40 \leq T_a \leq 60^\circ\text{C}$ Ex nA [nL]Terminal: 1,2
Ex nATerminal: 1,2
Ex nL or Ex icUo: 27 V
Io: 7.0 mA
Po: 45 mW
Lo: 35 mH
Co: 90 nFU \leq 35 VDC
I = 4 - 20 mAUi = 35 VDC
Li = 10 μH
Ci = 1.0 nF

Special conditions for safe use

For use in a potentially explosive atmosphere of flammable gasses, vapours or mists, the transmitter shall be mounted in an enclosure providing a degree of protection of at least IP54 in accordance to EN60529.

For use in the presence of combustible dusts the transmitter shall be mounted in an enclosure providing a degree of protection of at least IP6X in accordance with EN60529. The surface temperature of the enclosure shall be determined after installation of the transmitter.

For an ambient temperature $\geq 60^\circ\text{C}$, heat resistant cables shall be used with a rating of at least 20 K above the ambient temperature.

Schéma d'installation ATEX

Pour une installation sûre du 5333A vous devez observer ce qui suit. Le module sera seulement installé par un personnel qualifié qui est informé des lois, des directives et des normes nationales et internationales qui s'appliquent à ce secteur. L'année de la fabrication est indiquée dans les deux premiers chiffres dans le numéro de série.

Certificat ATEX KEMA 10ATEX 0003 X

Marquage  II 3 GD Ex nA [nL] IIC T6...T4
II 3 GD Ex nL IIC T6...T4

II 3 GD Ex nA [ic] IIC T6...T4
II 3 GD Ex ic IIC T6...T4

Standards EN 60079-0 : 2006, EN 60079-11 : 2007, EN 60079-15 : 2005

T4: -40 ≤ Ta ≤ 85°C T6: -40 ≤ Ta ≤ 60°C	Bornes : 3,4,6 Ex nA [nL] Uo: 27 V Io: 7,0 mA Po: 45 mW Lo: 35 mH Co: 90 nF	Bornes : 1,2 Ex nA U ≤ 35 Vcc I = 4 - 20 mA	Bornes : 1,2 Ex nL ou Ex ic Ui = 35 Vcc Li = 10 µH Ci = 1,0 nF
--	--	---	---

Conditions spécifiques à l'utilisation sûre :

Pour utilisation dans les atmosphères potentiellement explosibles dû à la présence de gaz, vapeurs ou brumes inflammables, le transmetteur doit être installé dans un boîtier de protection assurant un degré d'étanchéité d'au moins IP54 conformément à l'EN 60529.

Pour utilisation dans la présence de poussières combustibles, le transmetteur doit être installé dans un boîtier de protection assurant un degré d'étanchéité d'au moins IP6X conformément à l'EN 60529. La température de surface du boîtier doit être déterminée après l'installation des unités.

Pour une température ambiante ≥60°C, il faut utiliser des câbles résistant aux températures élevées avec une capacité nominale d'au moins 20 K au dessus de la température ambiante.

ATEX Installationszeichnung

Für die sichere Installation von 5333A ist Folgendes zu beachten: Das Gerät darf nur von qualifiziertem Personal eingebaut werden, dies mit den nationalen und internationalen Gesetzen, Richtlinien und Standards auf diesem Gebiet vertraut ist. Das Baujahr kann aus den ersten beiden Ziffern der Seriennummer ersehen werden.

ATEX-Zertifikat KEMA 10ATEX 0003 X

Markierung  II 3 GD Ex nA [nL] IIC T6...T4
II 3 GD Ex nL IIC T6...T4

II 3 GD Ex nA [ic] IIC T6...T4
II 3 GD Ex ic IIC T6...T4

Richtlinien EN 60079-0 : 2006, EN 60079-11 : 2007, EN 60079-15 : 2005

T4: -40 ≤ Ta ≤ 85°C T6: -40 ≤ Ta ≤ 60°C	Klemme: 3,4,6 Ex nA [nL] Uo: 27 V Io: 7,0 mA Po: 45 mW Lo: 35 mH Co: 90 nF	Klemme: 1,2 Ex nA U ≤ 35 VDC I = 4 - 20 mA	Klemme: 1,2 Ex nL oder Ex ic Ui = 35 VDC Li = 10 µH Ci = 1,0 nF
--	---	--	--

Sonderbedingungen für sichere Anwendung:

Für Anwendung in einer potentiellen explosiven Atmosphäre - basierend auf entflammbaren Gas, Dämpfen, Nebeln - muss der Messumformer in einem Gehäuse, welcher einen Schutzgrad von mindestens IP 54 gemäß EN 60529 besitzt, eingebaut werden.

Für Anwendung in die Präsenz von entflammbaren Staub, muss der Messumformer in einem Gehäuse, welcher einen Schutzgrad von mindestens IP 6X gemäß EN 60529 besitzt, eingebaut werden. Die Oberflächentemperatur des Gehäuses muss nach der Installation der Einheiten festgestellt werden.

Bei einer Umgebungstemperatur ≥60°C müssen hitzebeständige Leitungen eingesetzt werden, welche für eine mindestens 20 K höhere Umgebungstemperatur zugelassen sind.

ATEX Installationstegning

For sikker installation af 5333A skal følgende overholdes: Modulet må kun installeres af kvalificerede personer, som er bekendt med national og international lovgivning, direktiver og standarder i det land, hvor modulet skal installeres.
Produktionsår fremgår af de to første cifre i serienummeret.

ATEX-certifikat KEMA 10ATEX 0003 X

Mærkning  II 3 GD Ex nA [nL] IIC T6...T4
II 3 GD Ex nL IIC T6...T4

II 3 GD Ex nA [ic] IIC T6...T4
II 3 GD Ex ic IIC T6...T4

Standarder EN 60079-0 : 2006, EN 60079-11 : 2007, EN 60079-15 : 2005

T4: $-40 \leq T_a \leq 85^\circ\text{C}$ T6: $-40 \leq T_a \leq 60^\circ\text{C}$	Klemme: 3,4,6 Ex nA [nL] U _o : 27 V I _o : 7,0 mA P _o : 45 mW L _o : 35 mH C _o : 90 nF	Klemme: 1,2 Ex nA U = 35 VDC I = 4 - 20 mA	Klemme: 1,2 Ex nL eller Ex ic U _i = 35 VDC L _i = 10 μH C _i = 1,0 nF
--	--	--	--

Særlige betingelser for sikker anvendelse:

Ved installationer i eksplosive atmosfærer forårsaget af gasser, dampe eller tåger, skal transmitteren monteres i et hus med en tæthedegrad på mindst IP54 i overensstemmelse med EN 60529.

Ved installationer i områder med potentiel eksplosionsfare på grund af brændbart støv, skal transmitteren monteres i et hus med en tæthedegrad på mindst IP6X i overensstemmelse med EN 60529. Husets overfladetemperatur bestemmes efter installation af enhederne.

Hvis omgivelsestemperaturen $\geq 60^\circ\text{C}$, skal der bruges varmebestandige kabler med specifikationer på mindst 20K over omgivelsestemperaturen.

ATEX Installation drawing



5333
For safe installation of 5333D the following must be observed. The module shall only be installed by qualified personnel who are familiar with the national and international laws, directives and standards that apply to this area.
Year of manufacture can be taken from the first two digits in the serial number.

ATEX Certificate KEMA 03ATEX 1535

Mærkning  II 1 G Ex ia IIC T6...T4
II 1 D Ex iaD

Standards EN 60079-0 : 2006, EN 60079-11 : 2007, EN 60079-26 : 2007, EN 61241-0 : 2006, EN 61241-11 : 2006

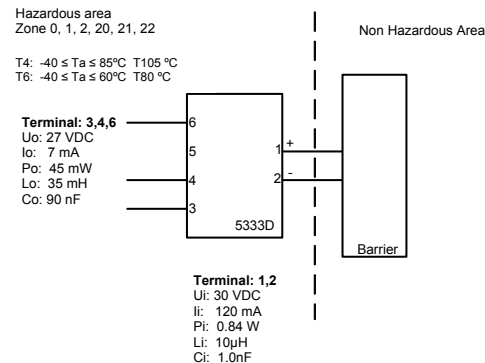

Installation notes:

In a potentially explosive gas atmosphere, the transmitter shall be mounted in an enclosure in order to provide a degree of protection of at least IP20 according to EN60529.

If the transmitter is installed in an explosive atmosphere requiring the use of equipment of category 1G and if the enclosure is made of aluminium, it must be installed such, that even in the event of rare incidents, ignition sources due to impact and friction, sparks are excluded; if the enclosure is made of non-metallic materials, electrostatic charging shall be avoided.

For installation in a potentially explosive dust atmosphere, the following instructions apply:

The transmitter shall be mounted in a metal enclosure form B according to DIN43729 that is providing a degree of protection of at least IP6X according to EN60529 that is suitable for the application and correctly installed.

Cable entries and blanking elements shall be used that are suitable for the application and correctly installed.

For an ambient temperature $\geq 60^{\circ}\text{C}$, heat resistant cables shall be used with a rating of at least 20 K above the ambient temperature.

The surface temperature of the enclosure is equal to the ambient temperature plus 20 K, for a dust layer with a thickness up to 5 mm

Schéma d'installation ATEX

5333

Pour une installation sûre du 5333D vous devez observer ce qui suit. Le module sera seulement installé par un personnel qualifié qui est informé des lois, des directives et des normes nationales et internationales qui s'appliquent à ce secteur. L'année de la fabrication est indiquée dans les deux premiers chiffres dans le numéro de série.

Certificat ATEX KEMA 03ATEX 1535

Marquage II 1 G Ex ia IIC T6, T4
II 1 D Ex iaD

Standards EN 60079-0 : 2006, EN 60079-11 : 2007, EN 60079-26 : 2007,
EN 61241-0 : 2006, EN 61241-11 : 2006

Zone dangereuse
Zone 0, 1, 2, 20, 21, 22

T4: $-40 \leq T_a \leq 85^{\circ}\text{C}$ T105 °C
T6: $-40 \leq T_a \leq 60^{\circ}\text{C}$ T80 °C

Bornes: 3,4,6

Uo: 27 Vcc
Io: 7 mA
Po: 45 mW
Lo: 35 mH
Co: 90 nF

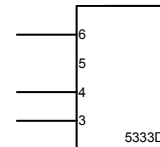
Bornes: 1,2

Ui: 30 Vcc
Ii: 120 mA
Pi: 0,84 W
Li: 10 μH
Ci: 1,0 nF

Zone non dangereuse

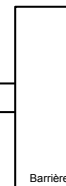

Notes d'installation:

Dans les atmosphères potentiellement explosibles dû à la présence de gaz, le transmetteur doit être installé dans un boîtier de protection assurant un degré d'étanchéité d'au moins IP20 conformément à l'EN 60529.

Pour les installations dans les atmosphères explosibles exigeant des appareils de catégorie 1G, et dans le cas où le boîtier est fait d'aluminium, le boîtier doit être installé dans une telle manière que, même dans le cas d'incidents rares, les sources d'inflammation dues aux impacts et aux étincelles de friction ne peuvent se produire; dans le cas où le boîtier est fait de matériaux non métalliques, les décharges électrostatiques sur le boîtier du transmetteur doivent être évitées.

Pour les installations dans les atmosphères potentiellement explosibles dû à la présence de poussières combustibles on doit observer ce qui suit :

Le transmetteur monté dans un boîtier métallique DIN B conformément à DIN 43729. Ce boîtier doit assurer un degré d'étanchéité d'au moins IP 6X conformément à l'EN 60529 et il doit convenir à l'application et être correctement installé.

Seulement des raccords de câble et des bouchons convenant à l'application et correctement installés doivent être utilisés.

Pour une température ambiante $\geq 60^{\circ}\text{C}$, il faut utiliser des câbles résistant aux températures élevées avec une capacité nominale d'au moins 20 K au dessus de la température ambiante.

La température superficielle du boîtier égale la température ambiante plus 20K, pour une couche de poussière d'un épaisseur jusqu'à 5 mm.

ATEX Installationszeichnung

5333

Für die sichere Installation von 5333D ist Folgendes zu beachten: Das Gerät darf nur von qualifiziertem Personal eingebaut werden, das mit den nationalen und internationalen Gesetzen, Richtlinien und Standards auf diesem Gebiet vertraut ist.
Das Baujahr kann aus den ersten beiden Ziffern der Seriennummer ersehen werden.

ATEX-Zertifikat KEMA 03ATEX 1535

Markierung II 1 G Ex ia IIC T6..T4
II 1 D Ex iaD

Richtlinien EN 60079-0 : 2006, EN 60079-11 : 2007, EN 60079-26 : 2007,
EN 61241-0 : 2006, EN 61241-11 : 2006

Ex-Bereich
Zone 0, 1, 2, 20, 21, 22

T4: $-40 \leq T_a \leq 85^{\circ}\text{C}$ T105 °C
T6: $-40 \leq T_a \leq 60^{\circ}\text{C}$ T80 °C

Klemme: 3,4,6

U_o: 27 VDC
I_o: 7 mA
P_o: 45 mW
L_o: 35 mH
C_o: 90 nF

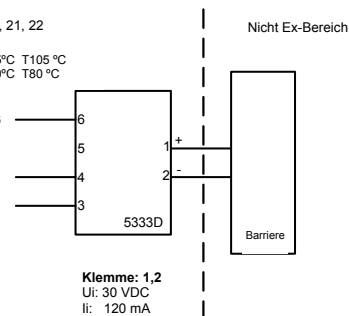

Klemme: 1,2

U_i: 30 VDC
I_i: 120 mA
P_i: 0,84 W
L_i: 10 μH
C_i: 1,0 nF

Installationsvorschriften:

Für Anwendung in einer potentiellen explosiven Atmosphäre - basierend auf entflammabaren Gas - muss der Messumformer in einem Gehäuse, welcher einen Schutzgrad von mindestens IP20 gemäß EN 60529 besitzt, eingebaut werden.

Für Applikationen in explosiver Atmosphäre, wo Kategorie 1G Geräte vorgeschrieben sind, und wenn das Gehäuse aus Aluminium ist, ist das Gehäuse so zu montieren, dass Zündquellen (Stöße und Reibungsfunkten) selbst bei selten auftretenden Störungen vermieden werden; wenn das Gehäuse aus nichtmetallischen Bestandteile ist, muss die elektrostatische Ladung der Gehäuse vermieden werden.

Für Anwendung in einer potentiellen explosiven Atmosphäre - basierend auf entflammabaren Staub - ist Folgendes zu beachten:

Der Messumformer muss in einem Metallkopf Form B gemäß DIN 43729 montiert werden. Das Gehäuse muss einen Schutzgrad von mindestens IP 6X gemäß EN 60529 besitzen und für den dementsprechenden Einsatz zugelassen werden.

Es dürfen nur Kabeleinführungen und Abdeckungen eingesetzt werden, welche für die jeweilige Anwendung zugelassen sind.

Bei einer Umgebungstemperatur $\geq 60^\circ\text{C}$ müssen hitzebeständige Leitungen eingesetzt werden, welche für eine mindestens 20 K höhere Umgebungstemperatur zugelassen sind.

Die Umgebungstemperatur der Gehäuse entspricht der Umgebungstemperatur plus 20K für eine Staubschicht mit einer Dicke von bis zu 5 mm.

ATEX Installationsteigning

5333

Før sikker installation af 5333D skal følgende overholdes: Modulet må kun installeres af kvalificerede personer, som er bekendt med national og international lovgivning, direktiver og standarder i det land, hvor modulet skal installeres. Produktionsår fremgår af de to første cifre i serienummeret.

ATEX-certifikat KEMA 03ATEX 1535

Mærkning II 1 G Ex ia IIC T6..T4
II 1 D Ex iaD

Standarder EN 60079-0 : 2006, EN 60079-11 : 2007, EN 60079-26 : 2007,
EN 61241-0 : 2006, EN 61241-11 : 2006

Ex-område
Zone 0, 1, 2, 20, 21, 22

T4: $-40 \leq T_a \leq 85^\circ\text{C}$ T105 $^\circ\text{C}$
T6: $-40 \leq T_a \leq 60^\circ\text{C}$ T80 $^\circ\text{C}$

Klemme: 3,4,6
U_o: 27 VDC
I_o: 7 mA
P_o: 45 mW
L_o: 35 mH
C_o: 90 nF

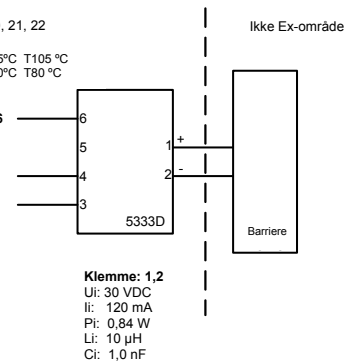

Installationsforskrifter:

I områder med potentiel eksplosionsfare på grund af brændbar gas skal transmitteren installeres i et hus med en kapslingsklasse på mindst IP20 i overensstemmelse med EN60529.

Hvis transmitteren installeres i eksplosive atmosfærer, hvor kategori 1G udstyr er krævet, og hvis huset er lavet af aluminium, skal det installeres således, at der selv ved sjældent opstående hændelser ikke er risiko for antændelse på grund af stød og friktionsgnister; hvis huset er lavet af ikke-metallisk materiale, skal elektrostatiske ladninger på transmitters hus undgås.

For installation i områder med potentiel eksplosionsfare på grund af brændbart støv skal følgende overholdes:

Transmitteren skal monteres i et form B metalhus i overensstemmelse med DIN 43729. Huset skal have en tæthedegrad på mindst IP 6X i overensstemmelse med EN 60529 og skal være egnet til den pågældende applikation samt være installeret korrekt.

Der må kun anvendes kabelforskrutninger og blindstik, som egner sig til den pågældende applikation og som installeres korrekt.

Hvis omgivelsestemperaturen $\geq 60^{\circ}\text{C}$, skal der bruges varmebestandige kabler med specifikationer på mindst 20K over omgivelsestemperaturen.

Husets overfladetemperatur er lig med den maksimale omgivelsestemperatur plus 20 K for støvlag med en tykkelse på op til 5 mm.

Installation Drawing 5300Q502.
Model 5331C, 5331D, 5333C and Hazardous (Classified) Location

Class I, Division 1, Groups, A, B, C, D
Class II, Division 1, Groups E, F, G or
Class I, Zone 0, IIC

Ambient temperature limits
T4: -40 to +85 deg. Celcius
T6: -40 to +60 deg. Celcius

Terminal 1, 2
Vmax or Ui: 30 V
Imax or Ii: 120 mA
Pmax or Pi: 0.84 W
Ci: 1 nF
Li: 10 μH

Terminal 3, 4, 5, 6
Only passive, or non-energy storing devices such as PTD's and Thermocouples may be connected.

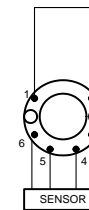
5333D Non Hazardous Location

Associated Apparatus or Barrier with entity Parameters:
UM \leq 250V
Voc or Uo \leq Vmax or Ui
Isc or Io \leq Imax or Ii
Po \leq Pi
Ca or Co \geq Ci + Ccable
La or Lo \geq Li + Lcable

This device must not be connected to any associated apparatus which uses or generates more than 250 VRMS

Model 5335C, 5335D.
Hazardous (Classified) Location

Class I, Division 1, Groups, A, B, C, D
Class II, Division 1, Groups E, F, G or
Class I, Zone 0, IIC

Ambient temperature limits
T4: -40 to +85 deg. Celcius
T6: -40 to +60 deg. Celcius

Terminal 1, 2
Vmax or Ui: 30 V
Imax or Ii: 120 mA
Pmax or Pi: 0.84 W
Ci: 1 nF
Li: 10 μH

Terminal 3, 4, 5, 6
Vt or Uo: 8.8 V
It or Io: 28 mA
Pt or Po: 67.2 mW
Ca or Co: 3.5 μF
La or Lo: 35 mH

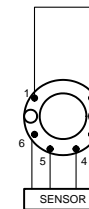
Non Hazardous Location

Associated Apparatus or Barrier with entity Parameters:
UM \leq 250V
Voc or Uo \leq Vmax or Ui
Isc or Io \leq Imax or Ii
Po \leq Pi
Ca or Co \geq Ci + Ccable
La or Lo \geq Li + Lcable

This device must not be connected to any associated apparatus which uses or generates more than 250 VRMS

The entity concept.

The Transmitter must be installed according to National Electrical Code (ANSI-NFPA 70).

When installed in Class II locations the Transmitter shall be installed in an enclosure with a specified ingress protections of IP6X according to IEC60529 and Dust-tight conduit seals must be used.

Equipment that is FM-approved for intrinsic safety may be connected to barriers based on the ENTITY CONCEPT. This concept permits interconnection of approved transmitters, meters and other devices in combinations which have not been specifically examined by FM, provided that the agency's criteria are met. The combination is then intrinsically safe, if the entity concept is acceptable to the authority having jurisdiction over the installation.

The entity concept criteria are as follows:

The intrinsically safe devices, other than barriers, must not be a source of power. The maximum voltage $U_i(V_{MAX})$ and current $I_i(I_{MAX})$, and maximum power $P_i(P_{MAX})$, which the device can receive and remain intrinsically safe, must be equal to or greater than the voltage (U_o or V_{oc} or V_i) and current (I_o or I_{sc} or I_i) and the power P_o which can be delivered by the barrier.

The sum of the maximum unprotected capacitance (C) for each intrinsically device and the interconnecting wiring must be less than the capacitance (C_s) which can be safely connected to the barrier.

The sum of the maximum unprotected inductance (L) for each intrinsically device and the interconnecting wiring must be less than the inductance (L_s) which can be safely connected to the barrier.

The entity parameters U_o, V_{oc} or V_i and I_o, I_{sc} or I_i , and C_s and L_s for barriers are provided by the barrier manufacturer.

CSA Installation Drawing 533QC03.

5331D, 5333D and 5335D transmitters are intrinsically safe in Zone 0 Group IIC or Class I, Division 1, Group A,B,C,D when installed according to Installation Drawing.

1. Connections with separate power supply and receiver.

Output: Standard 4 – 20 mA loop

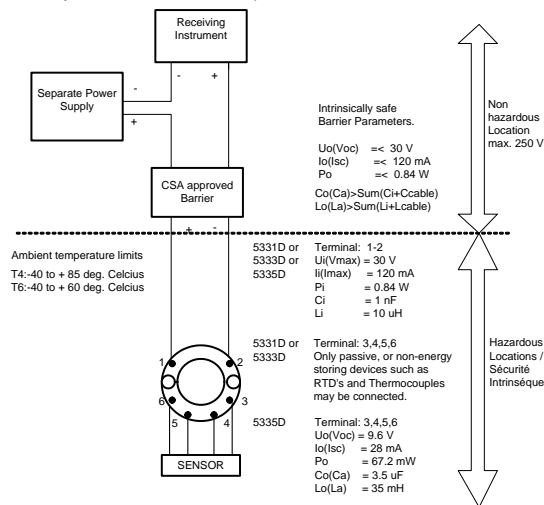

Warning:

Substitution of components may impair intrinsic safety.

The transmitters must be installed in a suitable enclosure to meet installation codes stipulated in the Canadian Electrical Code (CEC).

2. Connection with power supply and barrier built into receiver.

Output: Standard 4 - 20 mA loop

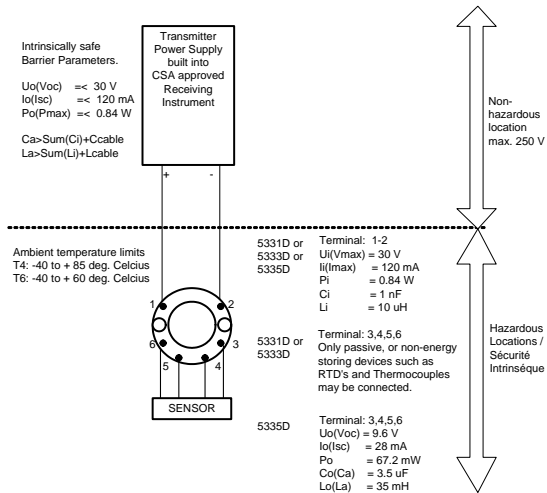

Warning:
 Substitution of components may impair intrinsic safety.

The Transmitters must be installed in a suitable enclosure to meet installation codes stipulated in the Canadian Electrical Code (CEC).

DK ▶ PR electronics A/S tilbyder et bredt program af analoge og digitale signalbehandlingsmoduler til industriel automation. Programmet består af Isolatorer, Displays, Ex-barrierer, Temperaturtransmittere, Universaltransmittere mfl. Vi har modulerne, du kan stole på i selv barske miljøer med elektrisk støj, vibrationer og temperaturudsving, og alle produkter opfylder de strengeste internationale standarder. Vores motto »Signals the Best« er indbegrebet af denne filosofi – og din garanti for kvalitet.

UK ▶ PR electronics A/S offers a wide range of analogue and digital signal conditioning modules for industrial automation. The product range includes Isolators, Displays, Ex Interfaces, Temperature Transmitters, and Universal Modules. You can trust our products in the most extreme environments with electrical noise, vibrations and temperature fluctuations, and all products comply with the most exacting international standards. »Signals the Best« is the epitome of our philosophy – and your guarantee for quality.

FR ▶ PR electronics A/S offre une large gamme de produits pour le traitement des signaux analogiques et numériques dans tous les domaines industriels. La gamme de produits s'étend des transmetteurs de température aux afficheurs, des isolateurs aux interfaces SI, jusqu'aux modules universels. Vous pouvez compter sur nos produits même dans les conditions d'utilisation sévères, p.ex. bruit électrique, vibrations et fluctuations de température. Tous nos produits sont conformes aux normes internationales les plus strictes. Notre devise »SIGNALS the BEST« c'est notre ligne de conduite - et pour vous l'assurance de la meilleure qualité.

DE ▶ PR electronics A/S verfügt über ein breites Produktprogramm an analogen und digitalen Signalverarbeitungsmodulen für die industrielle Automatisierung. Dieses Programm umfasst Displays, Temperaturtransmitter, Ex- und galvanische Signalrenner, und Universalgeräte. Sie können unsere Geräte auch unter extremen Einsatzbedingungen wie elektrisches Rauschen, Erschütterungen und Temperaturschwingungen vertrauen, und alle Produkte von PR electronics werden in Übereinstimmung mit den strengsten internationalen Normen produziert. »Signals the Best« ist Ihre Garantie für Qualität!

Subsidiaries

France

PR electronics Sarl
Zac du Chêne, Activillage
4, allée des Sorbiers
F-69673 Bron Cedex
sales@preelectronics.fr
tel. +33 (0) 4 72 14 06 07
fax +33 (0) 4 72 37 88 20

Germany

PR electronics GmbH
Im Erlengrund 26
D-46149 Oberhausen
sales@preelectronics.de
tel. +49 (0) 208 62 53 09-0
fax +49 (0) 208 62 53 09 99

Italy

PR electronics S.r.l.
Via Giulietti 8
IT-20132 Milano
sales@preelectronics.it
tel. +39 02 2630 6259
fax +39 02 2630 6283

Spain

PR electronics S.L.
Avda. Meridiana 354, 9^a B
E-08027 Barcelona
sales@preelectronics.es
tel. +34 93 311 01 67
fax +34 93 311 08 17

Sweden

PR electronics AB
August Barks gata 6A
S-421 32 Västra Frölunda
sales@preelectronics.se
tel. +46 (0) 3149 9990
fax +46 (0) 3149 1590

UK

PR electronics UK Ltd
Middle Barn, Apuldram
Chichester
West Sussex, PO20 7FD
sales@preelectronics.co.uk
tel. +44 (0) 1243 776 450
fax +44 (0) 1243 774 065

USA

PR electronics Inc
11225 West Bernardo Court
Suite A
San Diego, California 92127
sales@preelectronics.com
tel. +1 858 521 0167
fax +1 858 521 0945

Head office

Denmark
PR electronics A/S
Lerbakken 10
DK-8410 Rønne
www.preelectronics.com
sales@preelectronics.dk
tel. +45 86 37 26 77
fax +45 86 37 30 85

